

TRADOC DCSINT Handbook No. 1

A Military Guide to

Terrorism

in the Twenty-First Century

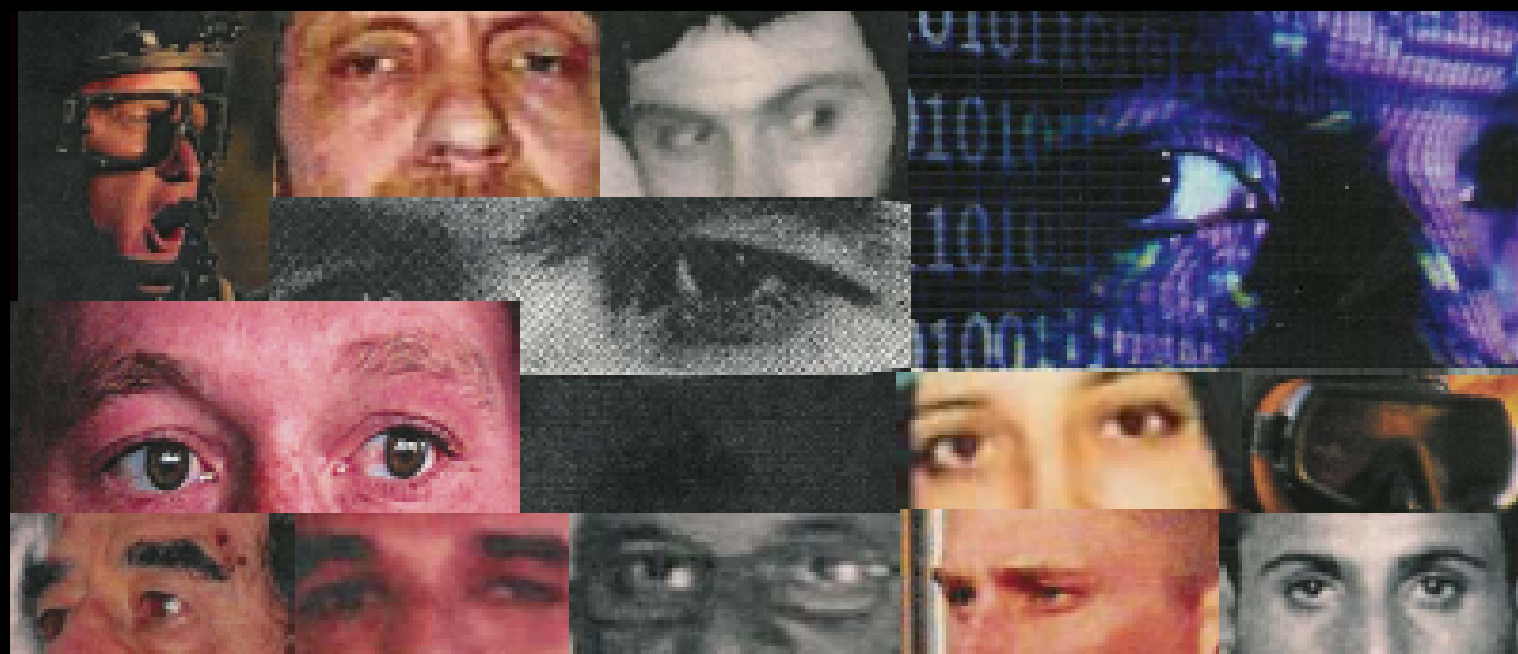
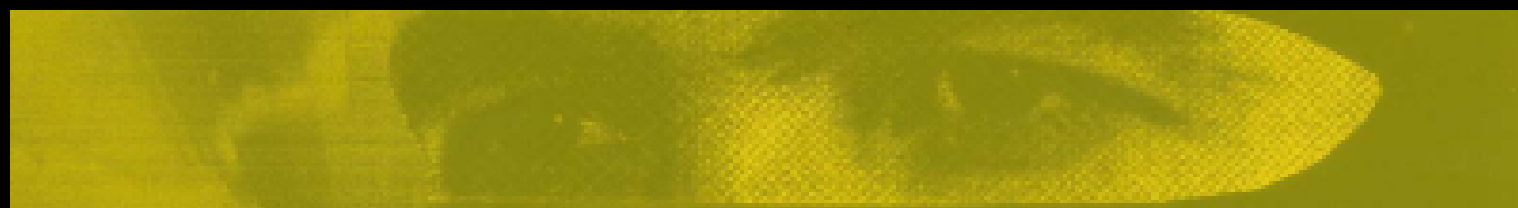

US Army Training and Doctrine Command
Deputy Chief of Staff for Intelligence
Assistant Deputy Chief of Staff for Intelligence - Threats
Fort Leavenworth, Kansas

15 August 2005

DISTRIBUTION RESTRICTION: Approved for public release; distribution unlimited.

Summary of Change

U.S. Army DCSINT Handbook No. 1 (Version 3.0) *A Military Guide to Terrorism in the Twenty-First Century*

Specifically, this handbook dated 15 August 2005 –

Provides an information update since the DCSINT Handbook No. 1, *A Military Guide to Terrorism in the Twenty-First Century*, publication dated 12 October 2004 (Version 2.0).

References the U.S. Department of State, Office of the Coordinator for Counterterrorism, *Country Reports on Terrorism 2004* dated April 2005, and the National Counterterrorism Center, *A Chronology of Significant International Terrorism for 2004*, dated 27 April 2005 for selected data on terrorism.

References the Department of Homeland Security, *National Response Plan*, dated December 2004.

Deletes Appendix H, *WMD and CBRNE Consequence Management*.

Refers to new Supplemental DCSINT Handbook No. 1.04, *Defense Support of Civil Authorities*, replaces Appendix H.

Deletes Appendix I, *Cyber Operations*.

Refers to new Supplemental DCSINT Handbook No. 1.02, *Cyber Operations and Cyber Terrorism*, replaces Appendix I.

Deletes Appendix J, *Case Studies in Terrorism*.

Refers to new Supplemental DCSINT Handbook No. 1.01, *Terror Operations: Case Studies in Terrorism*, replaces Appendix J.

Refers to new Supplemental DCSINT Handbook No. 1.03, *Suicide Bombing in the COE*, as an expansion on the topic of suicide bombing.

Expands the Selected Bibliography.

This 2005 Version 3.0 update supercedes DCSINT Handbook No. 1, *A Military Guide to Terrorism in the Twenty-First Century*, publication dated 12 October 2004 (Version 2.0).



A Military Guide
to
Terrorism
in the **Twenty-First Century**



U.S. Army Training and Doctrine Command
Deputy Chief of Staff for Intelligence
Assistant Deputy Chief of Staff for Intelligence – Threats

15 August 2005
Version 3.0

Page Intentionally Blank

Contents

Contents **i**

Preface..... **v**

ACKNOWLEDGEMENTS..... **vii**

Introduction **1**

 Purpose..... 4

 Scope of the Issue 4

 U.S. Strategic Overview..... 7

 U.S. Goals and Objectives 8

 GWOT and the Contemporary Operational Environment 9

 Conclusion 14

Chapter 1 Nature and History of Terror **1-1**

 Section I: What is Terrorism 1-2

 Section II: Historical Overview of Terrorism 1-13

 Conclusion 1-23

Chapter 2 Terrorist Behaviors, Motivations, and Characteristics..... **2-1**

 Section I: Terrorist Behavior..... 2-1

 Section II: Impact of Terrorist Goals & Motivations on Planning..... 2-7

 Section III: Terrorist Characteristics 2-12

 Conclusion 2-15

Chapter 3 Terrorist Group Organization..... **3-1**

 Section I: Terrorist Group Structure 3-2

 Section II: Categories of Terrorist Organizations 3-7

 Section III: Knowledge Exchange and Proliferation Between Organizations 3-11

 Conclusion 3-13

Chapter 4 Assessing Terrorist Capabilities and Intentions **4-1**

 Section I: Potential Adversaries and Their Motivations 4-4

 Section II: Considerations in Targeting U.S. Forces 4-6

 Section III: Categorizing Terrorist Groups by Capability..... 4-11

 Conclusion 4-17

Chapter 5 Terrorist Targeting of U.S. Military Forces..... **5-1**

 Section I: Categories of U.S. Forces 5-2

 Section II: Terrorist Threat to Deployed Forces 5-3

 Section III: Terrorist Threat to Deployable Forces 5-12

 Section IV: Terrorist Threat to Institutional (Non-Deployable) Forces..... 5-20

 Conclusion 5-27

Chapter 6 Future of Terrorism..... **6-1**

Section I: Future Trends in Terrorism..... 6-1
Section II: The Future of Conflict..... 6-9
Conclusion 6-14

Appendix A Terrorist Threat to Combatant Commands A-1
General A-1
U.S. Northern Command A-2
U.S. Southern Command A-3
U.S. European Command..... A-4
U.S. Central Command A-7
U.S. Pacific Command..... A-9

Appendix B Terrorist Planning Cycle..... B-1
Phase I: Broad Target Selection..... B-2
Phase II: Intelligence Gathering and Surveillance B-3
Phase III: Specific Target Selection..... B-3
Phase IV: Pre-attack Surveillance and Planning..... B-4
Phase V: Rehearsals B-4
Phase VI: Actions on the Objective B-5
Phase VII: Escape and Exploitation..... B-5

Appendix C Terrorist Operations and Tactics..... C-1
General C-1
Aircraft Threats C-12
Maritime Threats..... C-15
Suicide Tactics C-17
International Incidents..... C-19

Appendix D Firearms D-1
Handguns D-3
Submachine Guns D-7
Assault Rifles D-10
Sniper Rifles..... D-13
Shotguns..... D-16

Appendix E Improvised Explosive Devices E-1
General E-1
Explosive Charges..... E-2
Common Trigger Devices E-4
Types of IEDs E-8
Covert Firearms..... E-12
Evacuation Distance Tables E-13

Appendix F Conventional Military Munitions..... F-1
General F-1
Fragmentation Grenades F-1

Rocket Propelled Grenade..... F-3
Air Defense Weapons F-4
Bombs and Artillery F-6
Mines..... F-8

Appendix G Weapons of Mass Destruction/Effect..... G-1
General G-1
CBRNE Background..... G-2
Weapons of Mass Destruction Categories G-3
Availability and Dual Use..... G-16
Conclusion G-18

Glossary..... Glossary-1

Selected BibliographyBibliography-1

Page Intentionally Blank

Preface

A Military Guide to Terrorism in the Twenty-First Century is a reference guide prepared under the direction of the U.S. Army Training and Doctrine Command, Assistant Deputy Chief of Staff for Intelligence-Threats. Understanding terrorism spans foreign and domestic threats of nation-states, rogue states with international or transnational agent demonstrations, and actors with specific strategies, tactics, and targets. A central aspect of this terrorism guide comprises foreign and domestic threats against the United States of America in a contemporary operational environment (COE).

Purpose. This informational handbook supports operational missions, institutional training, and professional military education for U.S. military forces in the Global War on Terrorism (GWOT). This capstone document provides an introduction to the nature of terrorism and recognition of terrorist threats to U.S. military forces. A common situational awareness by U.S. military forces considers three principal venues: forces that are deployed, forces that are in transit to or from an operational mission, and forces that are primarily installation or institution support. Compiled from open source materials, this handbook promotes a “Threats” perspective and enemy situational awareness of U.S. strategies and operations in combating terrorism. Neither a counter-terrorism directive nor anti-terrorism manual, the handbook complements but does not replace training and intelligence products on terrorism.

Intended Audience. This handbook exists primarily for U.S. military forces, however, other applicable groups include interdepartmental, interagency, intergovernmental, civilian contractor, non-governmental, private volunteer, and humanitarian relief organizations.

Handbook Use. Study of contemporary terrorist behavior and motivation, terrorist goals and objectives, and a composite of probable terrorist tactics, techniques, and procedures (TTP) improves readiness of U.S. military forces. As a living document, this handbook will be updated as necessary to ensure a current and relevant resource. A selected bibliography presents citations for detailed study of specific terrorism topics. Unless stated otherwise, masculine nouns or pronouns do not refer exclusively to men.

Proponent Statement. Headquarters, U.S. Army Training and Doctrine Command (TRADOC) is the proponent for this publication. Periodic updates will accommodate emergent user requirements on terrorism. Send comments and recommendations on DA Form 2028 directly to TRADOC Assistant Deputy Chief of Staff for Intelligence – Threats at the following address: Director, TRADOC ADCSINT – Threats, ATTN: ATIN-L-T (Bldg 53), 700 Scott Avenue, Fort Leavenworth, Kansas 66027-1323. This handbook is available at Army Knowledge Online (www.us.army.mil). Additionally, the General Dennis J. Reimer Training and Doctrine Digital Library (www.adtdl.army.mil) lists the handbook as a special text.

Page Intentionally Blank

ACKNOWLEDGEMENTS

Threats Terrorism Team (T3) Network

The Deputy Chief of Staff for Intelligence at U.S. Army Training and Doctrine Command extends special appreciation to the many stakeholders who were invited to contribute information, subject matter expertise, and insight into the update of this 2005 unclassified terrorism handbook, *A Military Guide to Terrorism in the Twenty-First Century*.

This expanding partnership of the Threats Terrorism Team (T3) Network in conjunction with the Assistant Deputy Chief of Staff for Intelligence-Threats includes:

U.S. Northern Command, J2 Combined Intelligence and Fusion Center (CIFC)
U.S. Northern Command, Director of Operations, J3
U.S. Northern Command, J34, Force Protection and Risk Management Branch
U.S. Northern Command, J35
U.S. Northern Command, JTF-Civil Support, J5 Plans, CBRNE Consequence Management
U.S. European Command, Plans and Operations Center
U.S. Pacific Command, Antiterrorism and Training Branch, J34
U.S. Pacific Command, U.S. Marine Forces Pacific, G5
U.S. Central Command, J2
U.S. Special Operations Command, Center for Special Operations, J23
U.S. Southern Command, J2
U.S. Strategic Command, Joint Intelligence Center, J2201
U.S. Joint Forces Command, J9
U.S. Joint Forces Command, J34
Joint Staff, J34 Deputy Directorate for Antiterrorism/Homeland Defense
Joint Staff, J5 War on Terrorism Directorate, Strategic Planning Division
Joint Military Intelligence Training Center (JMITC)
State Department, Bureau of Diplomatic Security, Intelligence-Threats Analysis Directorate
Office of the Assistant Secretary of Defense for Homeland Defense
Department of Energy, Office of Headquarters Security Operations
Department of Homeland Security, Director Preparedness Division, Operational Integration Staff
Department of Homeland Security, Federal Emergency Management Agency, Region VII
Department of Homeland Security, Citizen Corps FEMA Region VII Program Manager
Department of Homeland Security, Transportation Security Administration, KCI Airport
Federal Bureau of Investigation (FBI) Terrorism Watch and Warning Unit
FBI, National Joint Terrorism Task Force (NJTTF)
FBI, Counterterrorism Division, Military Liaison and Detainee Unit
U.S. First Army Headquarters, Military Support Division, G3
U.S. Fifth Army Headquarters, G3
U.S. Navy Center for Antiterrorism and Navy Security Forces
U.S. Navy, Naval War College
U.S. Navy, Navy Command and Staff College
U.S. Marine Corps Training and Education Command, G3 Training Readiness, Plans and Policy
U.S. Marine Corps, Marine War College
U.S. Marine Corps, Marine Corps Command and Staff College
U.S. Air Force Security Forces Center
U.S. Air Force, National Air and Space Intelligence Center, Behavioral Influences Analysis Division
U.S. Air Force, Air War College
U.S. Air Force, Air Command and Staff College
U.S. Army Office of Deputy Chief of Staff G2, for Counterintelligence, HUMINT, and Security
U.S. Army Office of the Chief Information Officer (CIO)/G6

- U.S. Army Network Enterprise Technology Command, 9th ASC, G2
- U.S. Army Network Enterprise Technology Command, Office of Information Assurance
- U.S. Military Academy (West Point), Combating Terrorism Center (CTC)
 - U.S. Army Combined Arms Center (CAC)
 - U.S. Army Maneuver Support Center (MANSCEN)
 - U.S. Army Combined Arms Support Command (CASCOM)
 - U.S. Army Combined Arms Center-Training (CAC-T)
 - U.S. Army Battle Command Training Program (BCTP)
 - National Defense University
 - U.S. Army TRADOC Centers and Schools, including:
 - U.S. Army, Army War College
 - U.S. Army Command and General Staff College (CGSC)
 - U.S. Army Logistics Management College (ALMC)
 - U.S. Army Aviation Logistics Center
 - U.S. Army Management Staff College
 - U.S. Army School of Information Technology
 - U.S. Army Leader College for Information Technology
 - U.S. Army Fort Eustis, Directorate of Plans, Training, Mobilization, and Security
 - U.S. Army Command and General Staff School (CGSS)
 - U.S. Army School for Command Preparation (SCP)
 - U.S. Army School for Advanced Military Studies (SAMS)
 - U.S. Army Center for Army Leadership (CAL)
 - U.S. Army Infantry Center, G2 Director of Intelligence and Security
 - U.S. Army Intelligence Center, Futures Development and Integration Center
 - U.S. Army Warrant Officer Career Center
 - U.S. Army Sergeants Major Academy
 - U.S. Army Soldier Support Institute
 - U.S. Army Academy of Health Sciences, Medical Department Center and School
 - U.S. Army Nuclear and Chemical Agency
 - U.S. Northern Command, Homeland Security/Defense Education Consortium (HSDEC)
 - U.S. Army TRADOC, Assistant Deputy Chief of Staff for Intelligence-Threats**

Introduction

A Military Guide to Terrorism in the Twenty-First Century is a capstone reference guide that describes terrorism¹ and its potential impact on U.S. military forces in the conduct of mission operations. The handbook highlights the nature of terrorism present in a full spectrum contemporary operational environment (COE),² and the likely impacts on the conduct of U.S. military operations.

Despite the consistent menace, terrorism is a threat that is poorly understood, and frequently confused due to widely divergent views over exactly what defines terrorism. Terrorism, as discussed in this handbook, centers on known principal terrorist “Threats” to the United States of America. The United States confronts terrorism in daily circumstances, both foreign and domestic; and prepares for security against terrorism expected in the foreseeable future. The most significant U.S. concerns are terrorist organizations with demonstrated global reach capabilities and those terrorist organizations that seek to acquire and use weapons of mass destruction (WMD).

Nonetheless, the threat of terrorism to the U.S. is present across the entire spectrum of conflict. The use of terrorism ranges from individual acts of wanton damage or destruction to property or person, to highly sophisticated operations conducted by highly organized violent groups with social, environmental, religious, economic, or political agendas. This full range of terrorist activity can have significant negative impact on the conduct of missions by U.S. military forces.

The *Contemporary Operational Environment* (COE) has several common threads or constants for defining the environment. The U.S. will not experience a peer competitor until 2020 or beyond. Armed forces will continue to be used as a tool to pursue national interests. The U.S. may direct military action within the context of an alliance, a coalition, or even as unilateral action, with or without United Nations sanctions. Actions will be waged in a larger environment of diplomatic, informational, economic, and military operations. Modernization of capabilities by potential or known adversaries could negate U.S. overmatch for select periods of time or specific capabilities. Similarly, advanced technologies will be readily available on a world market for nation-states and non-state actors. Non-state actors can cause significant impacts on a military operation, as combatants and non-combatants. Of course, these factors and their effects will vary depending on a particular situation; however, a constant that must also be addressed is the issue of variables.

Complementing these overarching constants or factors, the U.S. Army describes eleven critical variables that enhance a comprehensive appreciation of a particular mission setting. This assessment and analysis is appropriate for both real world contingencies and training preparations. Whether a real world threat or an opposing force created to simulate realistic and relevant conditions for training readiness, the COE is a dynamic and adaptive process of being more aware, better prepared, and fully ready to counter any adversary that could negatively impact on conduct of an assigned U.S. military mission.

¹ Joint Publication 1-02. *Department of Defense Dictionary of Military Terms and Associated Terms*, 12 April 2001, as amended through 30 November 2004.

² U.S. Army Field Manual FM 7-100, *Opposing Force Doctrinal Framework and Strategy*, May 2003, iv to xvi.

Interaction among these elements may range from peaceful humanitarian assistance to high-intensity combat operations. Alliances and coalitions are the expectation in most operations, but U.S. unilateral action is always a consideration. Military operations interrelate with other elements of national power – diplomatic, economic, social-cultural, and informational – for both the U.S. and an adversary. Advanced technologies are available to almost anyone, yet sophistication of weapon systems, in itself, may be a liability. Intelligence and operational tools must overlap and integrate complex sensor-surveillance systems and the clarity of human intelligence “eyes on the ground” collection and analysis. Engagement among significant actors in the COE can span formal nation-state representatives to the impact of individual combatants and noncombatants. Acts of terrorism are part of this reality.

Critical Variables of the COE

- **Nature and Stability of the State**
- **Regional and Global Relationships**
- **Economics**
- **Sociological Demographics**
- **Information**
- **Physical Environment**
- **Technology**
- **External Environment**
- **National Will**
- **Time**
- **Military Capabilities**

(Source: U.S. Army Field Manual 7-100)

Terrorism has become one of the most pervasive and critical threats to the security of the United States in recent history. U.S. military fatalities from terrorist actions between 1980 and 2002 exceed the total battle deaths from Operations Urgent Fury (Grenada), Just Cause (Panama), and Desert Shield/Desert Storm (Persian Gulf).³ As Chart Intro-1 depicts active duty U.S. military deaths between 1980 and 2002, there were 672 military deaths attributed to either hostile action or terrorism. Of these deaths, 63% were due to terrorist actions.⁴ Since these Department of Defense figures only go through 2002, they do not include the most current casualties from Operation Enduring Freedom (OEF), or any of the casualties from Operation Iraqi Freedom (OIF). However, sampling reports on OEF⁵ and OIF⁶ present casualties and causes, with many of the casualties caused by terrorist actions in these two theaters. Recent statistics for 2005 illustrate a significant number of coalition military deaths

³ Department of Defense, Washington Headquarters Services, Directorate for Information Operations and Reports, *Table 13, Worldwide U.S. Active Duty Military Deaths, Selected Military Operations* (Washington, D.C., n.d.); available from <http://web1.whs.osd.mil/mmid/casualty/table13.htm>; Internet; accessed 6 July 2004.

⁴ Department of Defense, Washington Headquarters Services, Directorate for Information Operations and Reports, *U.S. Active Duty Military Deaths – 1980 through 2002* (Washington, D.C., As of 10 April 2003); available from http://web1.whs.osd.mil/mmid/casualty/Death_Rates.pdf; Internet; accessed 6 July 2004.

⁵ Department of Defense, Washington Headquarters Services, Directorate for Information Operations and Reports, *Global War on Terrorism – Casualty Summary Operation Enduring Freedom* (Washington, D.C., As of 25 September 2004); available from <http://web1.whs.osd.mil/mmid/casualty/WOTSUM.pdf>; Internet; accessed 4 October 2004.

⁶ Department of Defense, Washington Headquarters Services, Directorate for Information Operations and Reports, *War on Terrorism – Operation Iraqi Freedom, By Casualty Category Within Type* (Washington, D.C., As of 19 March 2005); available from <http://web1.whs.osd.mil/mmid/casualty/OIF-Total.pdf>; Internet; accessed 12 April 2005.

in Iraq caused by acts of terrorism via vehicle borne improvised explosive devices or other suicide attacks.⁷



On occasion, adversary combatant forces have adopted terrorist tactics to continue their fight when they no longer possess the ability or choice to conduct conventional engagement attacks. In the 2003 State Department *Patterns of Global Terrorism* Report, the State Department did make a distinction between military operations and terrorist attacks. Those attacks directed at combatants are not classified as terrorist attacks, whereas those against noncombatants (civilians and military personnel who at the time of the incident were unarmed and/or not on duty) were classified as terrorist attacks. Discrete measurement of terrorism effects on military forces becomes more difficult as forms of conflict overlap or merge during the conduct of operations. Regardless of how casualties are officially categorized, terrorism has been a major threat to the security of our armed forces for a number of years.

In 2004, selected statistical terrorism data in *Patterns* was criticized⁸ and revised. As a document widely accepted as a standard authoritative reference book, the 2005 *Patterns* will continue to be published by the Department of State; however, statistical data on terrorism previously associated within *Patterns* will be published separately by the Federal Government’s National Counterterrorism Center (NCTC).⁹

⁷ Army TRADOC ADCSINT-Threats, “OIF Top Causes of Death” Information Briefing, with Source Data from <http://www.centcom.mil/CENTCOMNews> and <http://casualties.org/oif/stats.aspx>; Internet; accessed 26 July 2005.

⁸ Raphael Perl, CRS Report for Congress, Order Code RL 32417, “The Department of State’s Patterns of Global Terrorism Report: trends, State Sponsors, and Related Issues,” Washington, D.C.: Congressional Research Service, The Library of Congress, 1 June 2004, Summary; available from <http://fpc.state.gov/documents/organization/33630.pdf>; Internet; accessed October 2004.

⁹ Susan B. Glasser, “Annual Terror Report Won’t Include Numbers,” *Washington Post*, 19 April, 2005, 17, available from <http://ebird.afis.osd.mil/ebfiles/e20050419364248.html>; Internet; accessed 19 April 2005.

Purpose

This U.S. Army TRADOC DCSINT handbook serves as an unclassified resource to inform U.S. military members on the nature and characteristics of terrorism. The intention is to create situational awareness and understanding of current terrorism capabilities and limitations, and complement the deliberate processes of military risk management, force protection, and mission orders conduct and leader decision-making.

From a “Threats” perspective, terrorism *capabilities and limitations* indicate possible and probable types of threat action that may be directed against U.S. military members, units, and organizations. Factors other than military power may place *constraints* on both threats and friendly forces. Commanders, organizational leaders, and other military members can “think like the threat” and use this handbook to create operational *opportunities* to:

- Understand the nature of the terrorist threat through a concise historical review of terrorism, and basic descriptions of methods and organizational structures commonly used by terrorists and terrorist organizations.
- Know terrorist goals and objectives, and the conduct of terrorist operations. Acknowledging that asymmetric operations provide a significant advantage to the terrorist, the study of situational patterns and techniques in terrorism over time can offer insight and possible trends for future attacks.
- Appreciate the terrorism threat to U.S. military forces, equipment, and infrastructure.
- Relate appropriate levels of force protection (FP), operational security (OPSEC), and terrorism countermeasures based upon unit status and situation.
- Provide relevant terrorism information that applies to Active Component (AC) and Reserve Component (RC) Federal Reserves and state National Guard forces in primary scenarios of being: (1) deployed on an operational mission, (2) in transit to or from an operational mission, or (3) nondeployable as a military force designated as installation or institutional support assignments.
- Complement research, analysis, and contingency techniques within a “red teaming” concept and process.¹⁰

Scope of the Issue

Terrorism is a significant operational condition for U.S. military forces in the twenty-first century. Terrorist violence has changed in recent years from an agenda-forcing and attention-getting tool of the politically disenfranchised to a significant asymmetric form of conflict employed against adversaries with economic, military, social, and political aims. While terrorist acts may have appeared to be extraordinary events several decades ago, today

¹⁰ Department of Defense, Defense Science Board, *Defense Science Board Task Force on The Role and Status of DoD Red Teaming Activities*, (Washington, D.C.: Office of the Under Secretary of Defense for Acquisition, Technology, and Logistics, September 2003).

terrorism eclipses these former acts and demonstrates a profound impact on populations at the local, regional, national, and international levels. Terrorists do not plan on defeating the U.S. in a purely military sense. As part of a larger listing of threats, "...foes today are not trying to defeat us [U.S.] purely militarily. They're approaching this from a far broader strategic context, and in fact, they're least interested in taking us [U.S.] on head-on. They're interested in tying us down militarily, but they are really working on defeating us informationally, economically, and politically, the other dimensions of National power."¹¹

Terrorism is defined by the U.S. Department of Defense (DoD) as: "The calculated use of unlawful violence or threat of unlawful violence to inculcate fear; intended to coerce or to intimidate governments or societies in the pursuit of goals that are generally political, religious, or ideological."¹² This is not a universally accepted definition outside of the Department of Defense, and the study of terrorism has often been mired in a conflict over definitions and semantics. For the purposes of this handbook, this DoD doctrinal definition will be used unless otherwise noted in the text.

Terrorism is a special type of violence; while it has a political element, it is a criminal act under nearly every national or international legal code. Although terrorism has not yet caused the physical devastation and large number of casualties normally associated with traditional warfare, terrorism often produces a significant adverse psychological impacts and presents a much greater threat than a simple compiling of the numbers killed or the quantity of materiel destroyed would indicate.¹³ Examples of this on the United States are the 9/11 attacks and the anthrax incidents of the same period. For many people around the U.S., these attacks weakened their sense of safety and security. This experience of catastrophic terrorism was evidence that the United States was not immune to attacks by international or transnational terrorist groups, or the acts of a possible lone terrorist. Ultimately, these attacks also had severe economic impacts on the country. As Brian Jenkins testified to the 9/11 Commission, "The September 11 attack produced cascading economic effects that directly and indirectly have cost the United States hundreds of billions of dollars."¹⁴ For other U.S. citizens, these terrorist acts fortified their will and resolve. Consequently, a national resolve emerged from these catastrophic incidents to reassert confidence in the economy and way of life, and to combat terrorism in the U.S. Homeland and on a global scale.

Terrorism

The calculated use of unlawful violence or threat of unlawful violence to inculcate fear; intended to coerce or to intimidate governments or societies in the pursuit of goals that are generally political, religious, or ideological.

Joint Pub 1-02

¹¹ General Peter Schoomaker, Army Chief of Staff, "CSA Interview: Joint and Expeditionary Capabilities," (Washington, D.C.: Pentagon, 4 October, 2004), available from <http://www.army.mil/leaders/leaders/csa/interviews/04Oct04.html>; Internet; Accessed 11 January 2005.

¹² FM 100-20, *Military Operations in Low Intensity Conflict*, 5 December 1990; and Joint Pub 1-02, *Department of Defense Dictionary of Military and Associated Terms*, 12 April 2001, as amended through 9 June 2004.

¹³ Bruce Hoffman, *Inside Terrorism* (New York: Columbia University Press, 1998), 33-34.

¹⁴ National Commission on Terrorist Attacks Upon the United States, Statement of Brian Jenkins to the Commission, March 31, 2003; available from http://www.9-11commission.gov/hearings/hearing1/witness_jenkins.htm; Internet; accessed 23 September 2004.

International concern about terrorism mounts too. Multinational groups in 2005 such as the Club of Madrid, comprised of former presidents and prime ministers of democratic countries, seek an international cooperation against terrorism. Principles include acknowledging terrorism as a crime against all humanity, recognizing terrorism an attack on democracy and human rights, and rejecting any ideology that guides the actions of terrorists.¹⁵ Similarly in March 2005, the Secretary-General of the United Nations called for a world treaty on terrorism that would outlaw attacks targeting civilians and establish a framework for a collective response to the global terrorist threat. A complementary decision might include a universal definition of terrorism, knowing that many different definitions exist currently for “terrorism,” to assist in countering terrorism in all of its forms.¹⁶

“Many potential adversaries, as reflected in doctrinal writings and statements, see U.S. military concepts, together with technology, as giving the United States the ability to expand its lead in conventional warfighting capabilities.

This perception among present and potential adversaries will continue to generate the pursuit of asymmetric capabilities against U.S. forces and interests abroad as well as the territory of the United States. U.S. opponents—state and such nonstate actors as drug lords, terrorists, and foreign insurgents—will not want to engage the U.S. military on its terms. They will choose instead political and military strategies designed to dissuade the United States from using force, or, if the United States does use force, to exhaust American will, circumvent or minimize U.S. strengths, and exploit perceived U.S. weaknesses. Asymmetric challenges can arise across the spectrum of conflict that will confront U.S. forces in a theater of operations *or on U.S. soil.*”

National Intelligence Council's "[Global Trends 2015: A Dialogue About the Future With Nongovernment Experts](#)" Report, December 2000.

Even though terrorism attracts attention and creates fear and anxiety, terrorist acts often fail to translate into concrete long-term gains or achieve an ultimate objective.¹⁷ Escalating acts of terrorism can be self-defeating when the acts become so extreme that public reaction loses attention on the terrorist’s intended purpose and focuses on the acts rather than the political issue. The example of Palestinian defiance to Israeli controls in this geographic region of the Mideast illustrates how progressively violent acts of resistance or terrorism can sometimes

¹⁵ *The Madrid Agenda*, Club de Madrid, available from <http://www.clubmadrid.org/cmadrid>; Internet; accessed 26 April 2005.

¹⁶ Ed McCullough, “Annan calls for treaty outlawing terrorism,” Associated Press, 10 March 2005; available from http://www.kentucky.com/mld/kentucky/news/weird_news/11099663.htm?template; Internet; accessed 26 April 2005.

¹⁷ Caleb Carr, *The Lessons of Terror: A History of Warfare Against Civilians: Why it has Always Failed and Why it will Fail Again* (New York: Random House, 2002), 11.

alienate large sections of public opinion that once may have supported a Palestinian quest for recognition.¹⁸ As a tactic, terror can be successful in its immediate purpose, but fail to achieve its ultimate aim unless dedicated political or military efforts coincide to produce tangible results.¹⁹ When the threat or use of terrorism is used in coordination with capabilities such as political or military power, strategic impact may be successful. Some may see the struggles for Algerian independence or Israeli independence as strategic outcomes that used terrorism as a major instrument of influence. Others may see the 2004 Spanish withdrawal from coalition forces in Iraq as an operational outcome of terrorism in Spain, and a means toward strategic terrorist aims of fracturing the coalition and eventually causing removal of U.S. presence and prestige in the Mideast.

U.S. Strategic Overview

Defending the Nation against its enemies is the first and fundamental commitment of the Federal Government. The National Military Strategy (2004) describes ways and means for Joint Forces to protect the U.S. and win the “War on Terrorism.” U.S. Joint Forces assist the Nation in preventing conflict or surprise attack, while concurrently transforming military capabilities while at war and preparing to meet future global challenges. In this contemporary operational environment, two primary U.S. concerns are terrorists of global reach and the emergent threat of terrorist use of weapons of mass destruction. The National Security Strategy (NSS) of the USA states national priorities for dealing with terrorism.

When the President of the United States of America addresses terrorism as an enemy, the enemy is not a single political regime or person or religion or ideology. “The enemy is terrorism – premeditated, politically motivated violence perpetrated against innocents...[U.S.] priority will be first to disrupt and destroy terrorist organizations of global reach and attack their leadership; command, control, and communications; material support; and finances.”²⁰ The strategic intent of the U.S. National Strategy for Combating Terrorism adds a national priority of denying sanctuary to terrorist organizations with global reach.²¹

Other principal threats are rogue states or terrorist organizations – enemies – who have declared the intention to obtain and use weapons of mass destruction [WMD] against the United States of America. The September 2001 attacks on the United States demonstrated that inflicting mass casualties is one of several specific means that will be used by terrorists to spotlight an agenda. Mass casualties would be exponentially more severe if terrorists acquired and used weapons of mass destruction.²² As noted in the U.S. National

¹⁸ Caleb Carr, “TIME.com Interview with Calib Carr,” 1 February 2002; available at <http://www.time.com/time/2002/carr/interview.html>; Internet; accessed 31 August 2004.

¹⁹ Walter Lacquer, *The New Terrorism: Fanaticism and the Arms of Mass Destruction* (New York: Oxford University Press, 1999), 48.

²⁰ President, National Strategy, *National Security Strategy of the United States of America*, Washington, D.C. (December 2002): Introduction and Section III; available from <http://www.whitehouse.gov/nsc/print/nssall.html>; Internet; accessed 8 December 2003.

²¹ President, National Strategy, *National Strategy for Combating Terrorism*, Washington, D.C. (February 2003): 11; available from <http://www.state.gov/s/ct/rls/rm/2003/17798.htm>; Internet; accessed 8 December 2003.

²² President, National Strategy, *National Security Strategy of the United States of America*, Washington, D.C. (December 2002): Section V; available from <http://www.whitehouse.gov/nsc/print/nssall.html>; Internet; accessed 8 December 2003.

Security Strategy, the targets of these WMD attacks include U.S. military forces and civilian population.

The major institutions of American national security were designed in a different era to meet different national and global requirements. All of these security measures are transforming. This includes building and maintaining national defenses beyond challenge...an essential role exists for American military strength in near-term readiness and the ability to fight the war on terrorism.²³

U.S. Goals and Objectives

The United States Government has a mandate to ensure the protection of the Nation and to reduce its vulnerability to terrorism. Leaders at each level of government are implementing interconnected strategies to address emerging risks and threats of terrorism. While protection infers prevention from terrorist attacks, U.S. national strategies recognize that managing risk of terrorist threats is a challenging continuum. One of the national strategies is *The National Strategy for Homeland Security*. This strategy presents six critical mission areas for security risk management and resource allocation: intelligence and warning, border and transportation security, domestic counterterrorism, protecting critical infrastructure, defending against catastrophic terrorism, and emergency preparedness and response.²⁴ A survey of these mission sets aligns readily with functions of expert support that U.S. military forces can provide, as an operating element of the Department of Defense, within Federal law.

Of note, the United States has implemented an integrated series of national strategies to enhance the security of the Nation. These strategies translate instruments of national power into strategic, operational and tactical actions against terrorism. U.S. military forces are part of a national arsenal of capabilities among diplomatic, economic, law enforcement, financial, information, and intelligence institutions in the Global War on Terrorism (GWOT).

**“No group or nation should mistake America’s intention:
We will not rest until terrorist groups of global reach have
been found, have been stopped, and have been defeated.”**

George W. Bush
The President of the United States of America
September 14, 2001

Soon after the catastrophe of the 2001 World Trade Center bombing, the President of the United States declared a specific charter to U.S. military forces: “The battle is now joined on many fronts. We will not waver, we will not tire, we will not falter and we will not fail. Peace and freedom will prevail...To all the men and women in our military, every sailor, every soldier, every airman, every coast guardsman, every marine, I say this: Your mission is

²³ Ibid., Section IX.

²⁴ President, National Strategy, *National Strategy for Homeland Security*, Washington, D.C. (16 July 2002): viii and 2; available from http://www.whitehouse.gov/homeland/book/nat_strat_hls.pdf; Internet; accessed 8 December 2003.

defined. The objectives are clear. Your goal is just. You have my full confidence, and you will have every tool you need to carry out your duty.”²⁵ As one of several instruments of national power, the “just” goal reaches beyond a task of just preserving U.S. freedoms. This goal envisions a world with the ability for all people to live and prosper without fear.

GWOT and the Contemporary Operational Environment

On a global scale, the *United States National Defense Strategy* has four strategic objectives: (1) secure the United States from direct attack, (2) secure strategic access and retain global freedom of action, (3) strengthen alliances and partnerships, and (4) establish favorable security conditions. Four ways that the U.S. accomplishes those objectives are assuring allies and friends, dissuading potential adversaries, deterring aggression and coercion, and when necessary, defeating adversaries.²⁶ These principles are integral to situational awareness in the Global War on Terrorism (GWOT).

The GWOT is an operational environment of today and for the foreseeable future. The *Operational Environment* (OE) as defined by the Department of Defense is: “A composite of the conditions, circumstances, and influences that affect employment of military forces and bear on the decisions of the unit commander.”²⁷ The U.S. Army builds on this DOD definition and further defines a mission setting for the current or the near-term future circumstances – the Contemporary Operational Environment.²⁸

Contemporary Operational Environment (COE) encompasses a full range of terrorism threat. This contemporary period can be assessed as “...the most dangerous times of our lifetime...not so much because we know precisely what somebody’s going to do, when and where, or how they’re going to do it; but that we know their intent and we know what the possibilities are and we know what our vulnerabilities are...So terrorism is part of the tactic. In other ways it’s [terrorism] an ‘ism’, much like communism and the others, only so much

Threat and Opposing Force

Threat - Any specific foreign nation or organization with intentions and military capabilities that suggest it could become an adversary or challenge the national security interests of the United States or its allies.

U.S. Army Regulation 350-2

Opposing Force (OPFOR) – A plausible, flexible military and/or paramilitary force representing a composite of varying capabilities of actual worldwide forces, used in lieu of a specific threat force, for training and developing U.S. forces.

U.S. Army Regulation 350-2

²⁵ “Transcript of President George Bush’s address 10/07/01,” ATTACK on AMERICA [database on-line]; available from <http://multimedia.belointeractive.com/attack/bush/1007bushtranscript.html>; Internet; accessed 13 July 2004.

²⁶ Department of Defense, *The National Defense Strategy of the United States of America*, (Washington, D.C.: GPO, 1 March 2005), iv.

²⁷ Department of Defense, *DOD Dictionary of Military Terms*, available from <http://www.dtic.mil/doctrine/jel/doddict/data/o/03843.html>; Internet; accessed 25 April 2005.

²⁸ Army Field Manual 7-100, *Opposing Force Doctrinal Framework and Strategy*, (Washington, D.C.: GPO, May 2003), Foreword and iv.

as it's embodied in whatever movements and for whatever reasons."²⁹ Originated to address known and potential *conditions* and adversaries that U.S. forces might confront in a post-Cold War world, the COE is a conceptual construct to recognize several norms and critical variables for military decisionmaking, planning, and operating. As a superpower, the U.S. must still consider the normal influences of movements and regional powers around the world and the capabilities of their armed forces, paramilitary forces, or clandestine groups.

Challenging Threats

- **Traditional**
- **Irregular**
- **Catastrophic**
- **Disruptive**

The U.S. National Defense Strategy identifies four types of challenging threats. Traditional challenges exist by states that employ recognized military capabilities and forces in the more conventional forms of military competition and conflict. Irregular challenges are the more unconventional ways and means to counter the traditional advantages of stronger opponents. Catastrophic challenges involve the acquisition, possession, and possible use of WMD or methods that produce WMD-like effects (WMD/E). Disruptive challenges may be the use of breakthrough technologies to limit or negate the operational advantage of an opponent.³⁰

The National Military Strategic Plan for the War on Terrorism (NMSP-WOT) addresses the GWOT nature of the threat, and states priorities and responsibilities within the U.S. Armed Forces. As noted by the U.S. Chairman of the Joint Chiefs of Staff, this strategy "...produces a clearer understanding of the enemies we face and the conditions under which we fight..." The nature of this environment is a war against extremists that advocate the use of violence to gain control over others, and in doing so, threaten our [U.S.] way of life. Success will rely heavily on close cooperation and integration of all instruments of national power and the combined efforts of the international community. The overall goal of this war is to preserve and promote the way of life of free and open societies based on rule of law, defeat terrorist extremism as a threat to that way of life, and create a global environment inhospitable to terrorist extremists.³¹

The United States will target eight major terrorist vulnerabilities. This targeting is against terrorist networks, including state and non-state supporters. The contemporary operational environment can be assessed as "...the most dangerous times of our lifetime...not so much because we know precisely what somebody's going to do, when and where, or how they're going to do it; but that we know their intent and we know what the possibilities are and we know what our vulnerabilities are...So terrorism is

Terrorist Vulnerabilities

- **Ideological Support**
- **Leadership**
- **"Foot Soldiers"**
- **Safe Havens**
- **Weapons**
- **Funds**
- **Communications and Movement**
- **Access to Targets**

Source: National Defense Strategy, March 2005

²⁹ General Peter Schoomaker, U.S. Army Chief of Staff, "Media Roundtable at the Association of the United States Army Annual Convention, Washington, D.C., 4 October 2004; available from: <http://www.army.mil/leaders/leaders/csa/interviews/04Oct04Roundtable.html>; Internet; accessed 11 January 2005.

³⁰ *The National Defense Strategy of the United States of America*, 1 March 2005, 2.

³¹ Joint Chiefs of Staff, J5 War on Terrorism, Strategic Planning Division, Briefing (U) *The National Military Strategic Plan for the War on Terrorism (NMSP-WOT)*, Version 18 April 2005.

part of the tactic. In other ways it's [terrorism] an 'ism', much like communism and the others, only so much as it's embodied in whatever movements and for whatever reasons."³² The intent is to maintain the initiative and dictate the tempo, timing, and direction of military operations.

As an example, denying resources to terrorists and terrorist networks is critical to countering the ideological support of terrorism. These efforts remove any legitimacy to terrorism and eliminate state and private support for terrorism; make it politically unsustainable for any country to support or condone terrorism; and support models for moderation in the Muslim regions of the world. Techniques in coordinating such actions may include a methodology of identifying or "mapping" key components that affect resources such as technology, key figures, and locations. Identifying the major connections among these components can spotlight weak assailable links of the networking and where targeting and action plans may be most effective. Measuring results and adapting operations enable a process for improved Joint leader education, training, and GWOT operations.³³

Interaction among these elements may range from peaceful humanitarian assistance to high-intensity combat operations. Alliances and coalitions are the expectation in most operations, but U.S. unilateral action is always a consideration. Military operations interrelate with other elements of national power – diplomatic, economic, social-cultural, and informational – for both the U.S. and an adversary. Advanced technologies are available to almost anyone, yet sophistication of weapon systems, it itself, may be a liability. Intelligence and operational tools must overlap and integrate complex sensor-surveillance systems and the clarity of human intelligence "eyes on the ground" collection and analysis. Engagement among significant actors in the COE can span formal nation-state representatives to the impact of individual combatants and noncombatants. Acts of terrorism are part of this reality.

Assessing the Threat

- **Mapping the Threat**
- **Analyzing Networks**
- **Planning Actions**
- **Determining Metrics**
- **Tracking Actions**
- **Evaluating Outcomes**
- **Adapting Methods**
- **Improving Results**

Red Teaming

Key to combating terrorism is the process of Red Teaming. As a time-proven concept used in U.S. government and commercial enterprises, red teaming deepens the understanding of options that are available to counter adaptive adversaries. This methodology both complements and informs intelligence collection and analysis, and enhances predictive estimates of adversary capabilities and intentions. Aggressive red teams challenge emerging operational concepts, evolving contingency plans, as well as operational orders in order to discover weaknesses before real adversaries do. The perspective of an adversary may be that of a confirmed threat,

³² General Peter Schoomaker, U.S. Army Chief of Staff, "Media Roundtable at the Association of the United States Army Annual Convention, Washington, D.C., 4 October 2004; available from: <http://www.army.mil/leaders/leaders/csa/interviews/04Oct04Roundtable.html>; Internet; accessed 11 January 2005.

³³ Joint Chiefs of Staff, J5 War on Terrorism, Strategic Planning Division, Briefing (U) *Countering Ideological Support for Terrorism*, Version 19Jan05, 5 April 2005.

or a contingency of threat capabilities used to present conditions, circumstances, and influences for training and readiness. Understanding rationale of a terrorist may involve detailed study of, in the case of al Qaeda or associated movements, salafi Islam and fundamentalism. Extremism can be a distorted variant of fundamental beliefs.

In 2003, a Defense Science Board task force validated two primary reasons for expanding the role of red teaming in the DoD: (1) To deepen understanding of the adversaries the U.S. now faces in the war on terrorism and in particular their capabilities and potential responses to U.S. initiatives, and (2) To guard against complacency. Red teaming can stress concepts, plans, and systems to identify vulnerabilities and capabilities before direct confrontation with a real world adversary. To best apply red teaming programs, red team members must be able to understand the thinking and motivations of adversaries with different cultural and social backgrounds, to assess and analyze acting as independent and adaptive adversaries, and to interact and recommend in constructive and creative ways with the supported friendly forces leader and military decisionmaker.³⁴

Approach to Understanding Terrorism

The 2005 version of *A Military Guide to Terrorism in the Twenty-First Century* builds on a database of open source information and current subject updates. Comments and recommendations from handbook users are instrumental in shaping updates, revisions, as well as identifying new requirements.

The preface keynotes this open source unclassified reference document on terrorism. The purpose and intended audience, although existing initially for U.S. military forces, provides a useful awareness to other activities in interagency, intergovernmental, nongovernmental, private volunteer, humanitarian relief, and civilian organizations. The introduction centers attention on reviewing historical perspectives of terrorism, understanding current vulnerabilities and terrorism threats, and considering emergent and future terrorism.

Chapter 1: *Nature and History of Terror*, defines the concept of terrorism and provides basic terms of reference for a common vocabulary. Attention on modern terrorism complements the historical perspective of terrorism discussed later in the handbook.

Chapter 2: *Terrorist Behaviors, Motivations, and Characteristics*, presents recent examples of terrorist behavior and illustrates individual or group declared ideology or philosophy. Additions expand generic profile descriptions with case examples to highlight the many types of lifestyle that can develop a terrorist's mindset and conduct.

Chapter 3: *Terrorist Group Organization*, provides examples and diagrams of hierarchical and networked terrorist group organizations, provides an appreciation of the diverse range of terrorist capability, but also portrays organizational limitations. Discussion of U.S. domestic terrorist acts accent this homeland threat, and the ability for inter-terrorist group transfer of information and support.

³⁴ Department of Defense, Defense Science Board, *Defense Science Board Task Force on The Role and Status of DoD Red Teaming Activities*, (Washington, D.C.: Office of the Under Secretary of Defense for Acquisition, Technology, and Logistics, September 2003), 1, 15, 16, and Appendix 1.

Chapter 4: ***Assessing Terrorist Capabilities and Intentions***, emphasizes risk assessment and management of U.S. military forces against terrorism. Vulnerabilities use a “red teaming” approach of potential terrorist intelligence preparation of the battlefield (IPB) against U.S. military forces. Appreciating terrorist intentions progresses to elements of potential terrorist reconnaissance and surveillance.

Chapter 5: ***Terrorist Targeting of U.S. Military Forces***, assesses potential targeting of U.S. military forces by terrorist organizations with a situational framework of deployed, deployable and in transit, or non-deployable U.S. military forces. Discussion includes the increased overseas presence by U.S. military forces in operational missions, forward stationed forces, and cycle of transiting forces with deployments and redeployments.

Chapter 6: ***Future of Terrorism***, examines the future of terrorism and the merging of terrorists with other state and sub-state entities. It also discusses some of the possible causes of future conflicts and how terrorism will be integrated into this evolution of conflict.

Appendices to Army TRADOC DCSINT Handbook No. 1 provide additional information to understanding terror, and the ways and means of conducting terrorism.

A: ***Terrorist Threat to Combatant Commands***. The annual publication of *Patterns of Global Terrorism 2003* by the U.S. Department of State remains the primary source for displaying terrorism threats to the five U.S. Combatant Command areas, and specific data to indicate regional and global patterns related to terrorism.

B: ***Terrorist Planning Cycle***. Emphasis outlines the norms of terrorist planning and phased conduct of operations. Operations may be sequential, parallel, or simultaneous.

C: ***Terrorist Operations and Tactics***. Examples describe emerging patterns in operations and inferences of preferred terrorism tactics and techniques. Descriptions expand the operating environment awareness to include land, air, and maritime terrorism scenarios.

D: ***Firearms***. Illustrations, photographs, and descriptions present a survey of conventional small arms often used by terrorists. Intelligence summaries provide the basis for this sampling of hand or shoulder fired weapons.

E: ***Improvised Explosive Devices***. Illustrations, photographs, and descriptions present a survey of explosive charges and trigger devices for improvised explosive devices (IED).

F: ***Conventional Military Munitions***. Illustrations, photographs, and descriptions present a survey of selected conventional military munitions used by terrorists including fragmentation grenades, rocket propelled grenades, shoulder-fired SAMS, and artillery munitions.

G: ***Weapons of Mass Destruction***. Discussion emphasizes multiple definitions of WMD and the underpinning of a common definition that focuses on weapon effects. Primary types of attack are chemical, biological, nuclear, radiological, and high yield explosives (CBRNE) in effects.

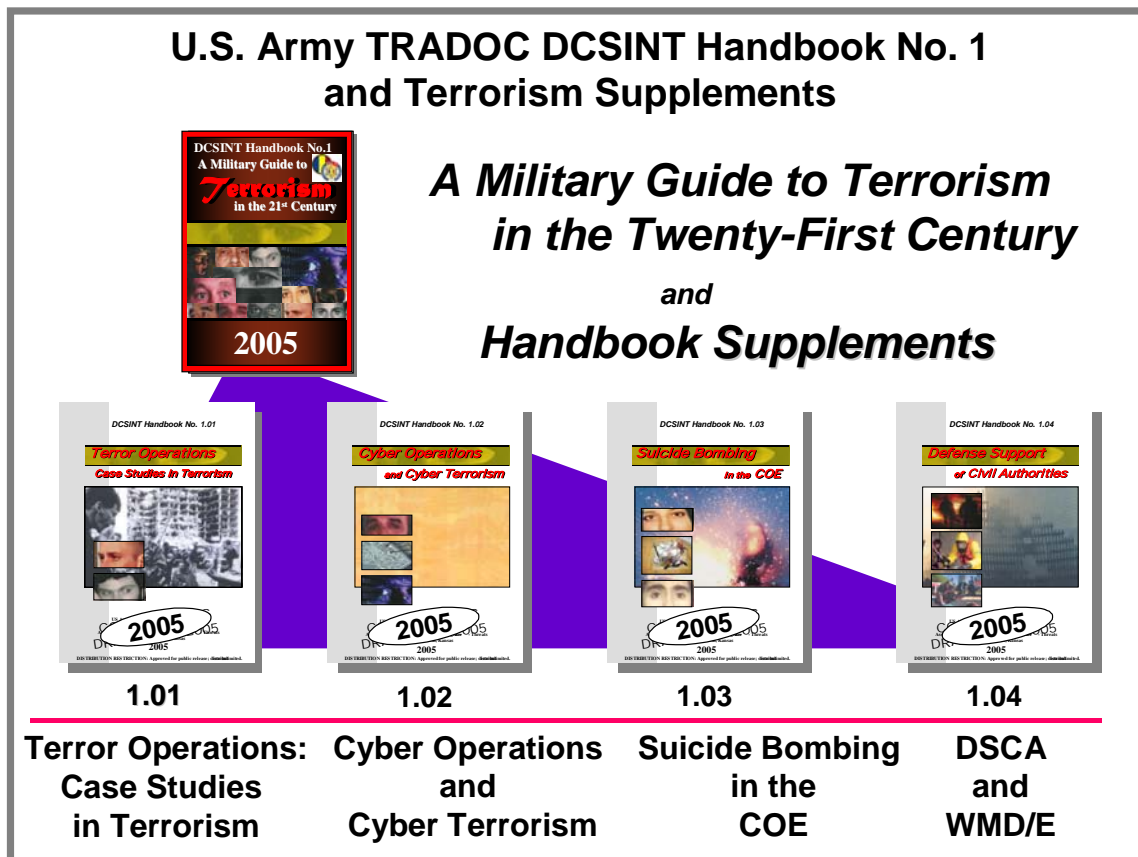

New in 2005, four supplemental handbooks to DCSINT Handbook No.1, *A Military Guide to Terrorism in the Twenty-First Century*, provides a more detailed discussion on topics of terrorism:

- DCSINT Handbook 1.01, *Terror Operations: Case Studies in Terrorism*.
- DCSINT Handbook 1.02, *Cyber Operations and Cyber Terrorism*.
- DCSINT Handbook 1.03, *Suicide Bombing in the COE*.
- DCSINT Handbook 1.04, *Defense Support to Civil Authorities (DSCA)*, with a focus on WMD/E consequence management and emergency response by military forces.

Conclusion

This capstone handbook and its supplemental handbooks provide a straightforward description of an increasingly common method of conflict – Terrorism. Promoting knowledge and awareness of terrorism enhances the ability of U.S. military forces to assess conditional vulnerabilities, determine enemy threats, dissuade and deter terrorist acts, deny use of

particular terrorism means, and effectively defend against terrorist attack.³⁵ The U.S. National Strategy for Combating Terrorism describes the campaigning along four simultaneous fronts: (1) defeat terrorist organizations of global reach through relentless action; (2) deny support to terrorism; (3) diminish the conditions that encourages terrorism; and (4) defend the people and interests of the United States of America against terrorism.³⁶

Ultimately, terrorism can cause more than physical carnage by imprinting psychological horror in the minds of the target audience. The aim of the terrorist, whether terrorism is viewed as a strategy, a campaign, or a tactic, is an attack on resolve. Therefore, the fundamental aim of terrorism is its psychological effect on man and the decisions that result.

The world today is complex, as is armed conflict. A significant difference today, different from previous recent wars, is the reality of a protracted conflict of uncertain duration³⁷ – a war on terrorism. To “detect, deter, and destroy terrorist organizations at every turn,” another evolving component of any U.S. action plan is to act against threats before they are fully formed. The ability to “red team” terrorist capabilities and limitations can be a powerful tool to understand risks and identify friendly forces options.

The overarching aim of this handbook is to create situational awareness and understanding of current terrorism capabilities and limitations, and complement the deliberate processes of military risk management, force protection, and mission orders conduct and leader decision-making. U.S. Armed Forces are at war – a Global War on Terrorism. In this long-term war of uncertain duration, the United States of America will continue to defend its values, liberties, and culture; its economic prosperity; and its security, along with allies and international partners.

³⁵ Moilanen, Jon H. “Engagement and Disarmament: A U.S. National Security Strategy for Biological Weapons of Mass Destruction,” *Essays on Strategy XIII*. Mary A. Sommerville ed., Washington, D.C., National Defense University Press, 1996.

³⁶ President, National Strategy, “National Strategy for Combating Terrorism,” Washington, D.C. (February 2003): 11, 29-30; available from <http://www.state.gov/s/ct/rls/rm/2003/17798.htm>; Internet; accessed 8 December 2003.

³⁷ Cofer Black, “The International Terrorism Threat,” Testimony before the House International Relations committee, Subcommittee on International Terrorism, Nonproliferation, and Human Rights, Washington, D.C., 26 March 2003; 6, available from <http://www.state.gov/s/ct/rls/rm/2003/19136.htm>; Internet; accessed 21 April 2005.

This Page Intentionally Blank

Chapter 1

Nature and History of Terror

"Terrorism is theatre."³⁸ This is a classic statement and analogy by terrorism expert Brian Jenkins for such a complex phenomenon as terrorism. Terrorism, like a play, can be viewed as a deliberate presentation to a large audience in order to spotlight a message and hold attention. The purpose and intent of such actions can have sinister impact on national, regional, and global populations. Modern media provide the stage, and audience attention is further engaged because random individuals are often targeted with principals on stage as victims. And like a play, the point of the experience is the feelings and attitudes of the audience, not the actors.

Terrorist acts or the threat of terrorism have been in existence for millennia. Despite a history longer than the modern nation-state, the use of terror by governments and those that contest their power remains poorly understood. While the meaning of the word *terror* itself is clear, when terror is applied to acts and actors in the real world of today. Meaning and intent can point in many directions. Part of this dilemma is due to use of terror tactics by actors at all levels in the social and political environments. Is the "Unabomber" with his solo campaign of terror, a criminal, terrorist, or revolutionary? Can he be compared to the French revolutionary governments who coined the word terrorism by instituting systematic state terror against the population of France in the 1790s? Are either of these examples similar to revolutionary terrorist groups such as the Baader-Meinhof Gang of West Germany or the Weather Underground in the United States?

Distinctions of size and political legitimacy of the actors using terror raise questions as to what is and is not terrorism. The concept of moral equivalency is frequently used as an argument to broaden and blur the definition of terrorism as well. This concept argues that the outcome of an action is what matters, not the intent.³⁹ Simply put, a car bomb on a city street or a jet fighter dropping a bomb on a tank are both acts of violence that produce death and horror. Therefore [at the extreme fringe of this argument] any military action is simply terrorism by a different name.⁴⁰ This is the reasoning behind the phrase "One man's terrorist is another man's freedom fighter." Such comments can promote a legacy of legitimizing the use of terror by successful revolutionary movements after the fact.

"Terrorism has a purpose that goes well beyond the act itself; the goal is to generate fear."

Opposing Force: Doctrinal Framework and Strategy FM 7-100 (2003)

Finally, the significant growth in the number of causes and social contexts using terrorism, combined with the flexibility and adaptability of terror throughout the years, has contributed to the confusion. Those seeking to disrupt, reorder, or destroy the status quo have continuously sought new and creative ways to achieve their goals. Although many of the

³⁸ Bruce Hoffman, *Inside Terrorism* (New York: Columbia University Press, 1998), 38.

³⁹ Bruce Hoffman, *Inside Terrorism* (New York: Columbia University Press, 1998), 33.

⁴⁰ *International Encyclopedia of Terrorism*, 1997 ed., s.v. "The Terrorists' View."

tactics and techniques used by terrorism have remained somewhat the same, significant improvements in technology have resulted in more lethal means.

Despite these problems, terrorism can be studied to gain useful conclusions. The first section of this chapter introduces a background of definitions and concepts for understanding terrorism. The second section provides a brief survey of the historical employment of terrorism. By establishing specific definitions and concrete concepts regarding terrorism, and determining how terror has been used in the past and in contemporary operations, potential future threats can be better understood and countered.

Section I: What is Terrorism

Terrorism has been described variously as both a tactic and strategy; a crime and a holy duty; a justified reaction to oppression and an inexcusable abomination. Much depends on whose point of view is being represented. Terrorism has often been an effective tactic for the weaker side in a conflict. As an asymmetric form of conflict, it confers coercive power with many of the advantages of military force at a fraction of the cost. Due to the secretive nature and small size of terrorist organizations, they often offer opponents no clear organization to defend against or to deter. Terrorism is a means to an “end” or objective. Methods may vary from incident to incident but in review of terrorism during the last two centuries, methods appear strikingly similar in concept.

What may be of most concern is the lethality and damage that adaptive terrorists can inflict when armed with expanding technologies and intellect. That is why preemption is more important than ever before. However, deterrence and preemption can be difficult against transnational terrorist groups. As stated in an al Qaeda article in January 2002, “[Deterrence] is completely eliminated when dealing with people who do not care about living but thirst for martyrdom. While the principle of deterrence works well [in warfare] between countries, it does not work at all for an organization with no permanent bases and with no capital in Western banks...How can such people, who strive for death more than anything else, be deterred?”⁴¹

In some cases, terrorism has been a means to carry on a conflict without the adversary realizing the nature of the threat, mistaking terrorism for criminal activity. Because of these characteristics, terrorism has become increasingly common among those pursuing extreme goals throughout the world. But despite its notoriety, terrorism can be a nebulous concept.

Related Definitions

Terrorist: (JP 1-02)

An individual who uses violence, terror, and intimidation to achieve a result.

Counter-terrorism: (JP 1-02)

Offensive measures taken to prevent, deter, and respond to terrorism.

Anti-terrorism: (JP 1-02)

Defensive measures used to reduce the vulnerability of individuals and property to terrorist acts, to include limited response and containment by local military forces.

⁴¹ Ben Venzke and Aimee Ibrahim, *The al-Qaeda Threat: An Analytical Guide to al-Qaeda's Tactics and Targets* (Alexandria: Tempest Publishing, LLC, 2003), 12, quoting Abu 'Ubeid al-Qurashi, “Fourth Generation Wars,” 28 January 2002.

Even within the U.S. Government, agencies responsible for different functions in the global war on terrorism use different definitions.

Defining Terrorism

The Department of Defense approved definition of terrorism is: “The calculated use of unlawful violence or threat of unlawful violence to inculcate fear; intended to coerce or to intimidate governments or societies in the pursuit of goals that are generally political, religious, or ideological.”⁴² For the purposes of this document, this will be the standard definition. However, this is not the last or only word on the subject. A researcher did a review of writings on terrorism and found 109 different definitions!⁴³ Here is a sampling of definitions to illustrate the difficulties of categorizing and analyzing terrorism.

The FBI uses this: “Terrorism is the unlawful use of force and violence against persons or property to intimidate or coerce a government, the civilian population, or any segment thereof, in furtherance of political or social objectives.”⁴⁴ The U.S. Department of State uses the definition contained in Title 22 U.S.C. Section 2656f(d). According to this section, “terrorism” means “premeditated politically-motivated violence perpetrated against non-combatant targets by sub-national groups or clandestine agents, usually intended to influence an audience.”⁴⁵ These definitions stress the respective institutional concerns of the organizations using them. The FBI concentrates on the “unlawful” aspect, in keeping with its law enforcement mission. The Department of State concerns itself with “politically motivated” actions by “sub-national” or “clandestine” actors, a focus appropriate to the Department’s functions of international relations and diplomacy.

Outside the United States Government, there are greater variations in what features of terrorism are emphasized in definitions. The United Nations produced this definition in 1992; “An anxiety inspiring method of repeated violent action, employed by (semi-) clandestine individual, group or state actors, for idiosyncratic, criminal or political reasons, whereby - in contrast to assassination - the direct targets of violence are not the main targets.” A commonly accepted academic definition starts with the U.N. definition quoted above, and adds two sentences totaling another 77 words; containing such concepts as “message generators” and “violence based communication processes.”⁴⁶ A more concise British Government definition of 1974 is “...the use of violence for political ends, and includes any use of violence for the purpose of putting the public, or any section of the public, in fear.”⁴⁷

There is clearly a wide choice of definitions for terrorism. Despite this, there are elements in common among the majority of useful definitions. Common threads of the various definitions identify terrorism as:

⁴² FM 100-20, *Military Operations in Low Intensity Conflict*, 5 December 1990; and Joint Publication 1-02, *Department of Defense Dictionary of Military and Associated Terms*, 12 April 2001, as amended through 09 January 2003.

⁴³ Bruce Hoffman, *Inside Terrorism* (New York: Columbia University Press, 1998), 39.

⁴⁴ Title 28, Code of Federal Regulations, Section 0.85, *Judicial Administration*, (Washington, D.C., July 2001).

⁴⁵ Department of State, *Patterns of Global Terrorism 2001* (Washington, D.C., May 2002), xvi.

⁴⁶ *International Encyclopedia of Terrorism*, 1997 ed., s.v. “The Academic View.”

⁴⁷ *Ibid.*, s.v. “The Official View.”

- Political
- Psychological
- Violent
- Dynamic
- Deliberate

Political

A terrorist act is a political act or is committed with the intention to cause a political effect. Clausewitz' statement that "war is a continuation of policy by other means" is taken as a truism by terrorists. They merely eliminate the intermediate step of armies and warfare, and apply violence directly to the political contest.⁴⁸ A U.S. State Department official summarized, "The ultimate goals of terrorism are political...Politically motivated terrorism invariably involves a deeply held grievance over some form of injustice. The injustice may be social or economic, but it is nonetheless blamed on a political authority."⁴⁹

Psychological

The intended results of terrorist acts cause a psychological effect or terror. They are aimed at a target audience other than the actual victims of the act. The intended target audience of the terrorist act may be a population as a whole, some specific portion of a society (an ethnic minority, for example similar to the situation in Kosovo between the Serbs and Albanians), or decision-making elites in the society's political, social, or military population.

Violent

Violence, coercion, and destruction are used in the commission of the act to produce the desired effect. Even if casualties or destruction are not the result of a terrorist operation, the threat or potential of violence is what produces the intended effect. For example, a successful hostage taking operation may result in all hostages being freed unharmed after negotiations and bargaining. Regardless of the outcome, the terrorist bargaining chips are nothing less than the raw threat of applying violence to maim or kill some or all of the hostages. When the threat of violence is not credible, or the terrorists are unable to implement violence effectively, terrorism fails.

Dynamic

Terrorist groups demand change, revolution, or political movement. The radical worldview that justifies terrorism mandates drastic action to destroy or alter the status quo. Even if the goals of a movement are reactionary in nature, they may require action to "turn back the clock" or restore some cherished value system that is extinct. Nobody commits violent attacks on strangers or innocents to keep things "just the way they are."

⁴⁸ Karl von Clausewitz, *War, Politics and Power* (Chicago: Regnery Gateway, 1962), 83.

⁴⁹ David E. Long, *The Anatomy of Terrorism* (New York: THE FREE PRESS, A Division of Macmillan, Inc., 1990), 4 and 5.

Deliberate

Terrorism is an activity planned and intended to achieve particular goals. It is a rationally employed, specifically selected tactic, and is not a random act.⁵⁰ Since the victims of terrorist violence are often of little import, with one being as good for the terrorists' purposes as another, victim or target selection can appear random or unprovoked. But the target will contain symbolic value or be capable of eliciting emotional response according to the terrorists' goals. Remember that the actual target of terrorism is not necessarily the victim of the violence, but the psychological impact on the society or population. This psychological impact is intended to create an environment of fear and intimidation that terrorists can then manipulate to force others to submit or agree to their demands.

Specific Observations

In addition to these common elements derived from attempts to define terrorism, some specific observations about terrorists become apparent. These observations are neither definitive nor are they automatically indicative of terrorist activity. But they are common to the practice of terrorism.

Media Exploitation

Terrorism effects are not necessarily aimed at the victims of terrorist violence. Victims are usually objects exploited by the terrorists for their effect on a third party. In order to produce this effect, information of the attack must reach the target audience. So any terrorist organization plans for exploitation of available media to get the message to the right audiences.⁵¹ Victims are simply the first medium that transmits the psychological impact to the larger target audience. The next step in transmission will depend on what media is available, but will be planned, and will be frequently the responsibility of a specific organization within the terrorist group to do nothing else but exploit and control the news cycle.⁵²

Some organizations can rely on friendly or sympathetic news outlets, but this is not necessary. News media can be manipulated by planning around the demands of the "news cycle," and the advantage that control of the initiative gives the terrorist. Pressures to report quickly, to "scoop" competitors, allow terrorists to present claims or make statements that might be refuted or critically commented on if time were available. Terrorists often provide names and details of individual victims to control the news media through its desire to humanize or personalize a story. For the victims of a terrorist attack, it is a certainty that the impact on the survivors (if there are any) is of minimal importance to the terrorists. What is important is the intended psychological impact that the news of their death or suffering will cause in a wider audience.

⁵⁰ Ehud Sprinzak, "Rational Fanatics," *Foreign Policy*, no. 120 (September/October 2000): 66-73.

⁵¹ Christopher C. Harmon, *Terrorism Today* (London: Frank Cass Publishers, 2000; reprint, Portland: Frank Cass Publishers, 2001), 55-58.

⁵² Bruce Hoffman, *Inside Terrorism* (New York: Columbia University Press, 1998), 33.

Operations in Permissive Societies

Terrorists conduct more operations in societies where individual rights and civil legal protections prevail. While terrorists may base themselves in repressive regimes that are sympathetic to them, they usually avoid repressive governments when conducting operations wherever possible. An exception to this case is a repressive regime that does not have the means to enforce security measures. Governments with effective security forces and few guaranteed civil liberties have typically suffered much less from terrorism than liberal states with excellent security forces. Al Qaeda has shown, however, that a terrorist organization with significant resources can span an extreme range of capability.

Illegality of Methods

Terrorism is a criminal act. Whether the terrorist chooses to identify himself with military terminology or with civilian imagery (e.g., brotherhood, committee), a terrorist is a criminal. Violations of civil criminal laws are self-evident in activities such as murder, arson, and kidnapping, regardless of the legitimacy of the government enforcing the laws. Victimized the innocent is criminal injustice under a dictatorship or a democracy.⁵³ If the terrorist claims that he is justified in using such violence as a military combatant, he could be possibly considered a de facto war criminal under international law and the military justice systems of most nations.

Preparation and Support

Terrorist operations are usually the result of extensive preparation and support operations. Media reporting and academic study have mainly focused on the terrorists' goals and actions, which is precisely what the terrorist intends. This neglects the critical but less exciting topic of preparation and support operations. Significant effort and coordination is required to finance group operations, procure or manufacture weapons, conduct target surveillance and analysis, and deliver trained terrorists to the operational area. The need for dedicated support activities and resources on relatively simple operations are significant and increases the sophistication of plans and complexity of the target.

Differences between Terrorism and Insurgency

For the U.S. military, two related concepts that can overlap with terrorism are guerilla warfare and insurgency. Although insurgencies and terrorism often have similar goals,⁵⁴ closer examination identifies specific differences between insurgency, guerilla warfare, and terrorism. To begin with, an insurgency is a movement, that is, a political effort with a specific aim to overthrow a constituted government. Both guerilla warfare and terrorism can be viewed as methods available to pursue the goals of the political movement.

⁵³ Christopher C. Harmon, *Terrorism Today* (London: Frank Cass Publishers, 2000; reprint, Portland: Frank Cass Publishers, 2001), 190.

⁵⁴ *International Encyclopedia of Terrorism*, 1997 ed., s.v. "Theories of Insurgency and Terrorism: Introduction."

Another difference is there is nothing inherent in either insurgency or guerrilla warfare that requires the use of terror. While some of the more successful insurgencies and guerilla campaigns employed terrorism, and some developed into conflicts where use of terror tactics and terrorism became predominant, there have been other examples that effectively renounced the use of terrorism. The deliberate choice to use terrorism considers its effectiveness in inspiring further resistance, destroying government efficiency, and mobilizing support.⁵⁵ Although there are places where terrorism, guerilla warfare, and criminal behavior all overlap, groups that are exclusively terrorist, or subordinate “wings” of insurgencies formed to specifically employ terror tactics, usually demonstrate differences in their objectives and operations. Disagreement on the intended benefits of using terror tactics, or whether terror operations are to be given primacy within the insurgency campaign, have frequently led to the “urban guerilla” or terrorist wings of an insurgency splintering off to pursue a revolutionary goal by their own methods.

Insurgency: (JP 1-02)(NATO)

An organized movement aimed at the overthrow of a constituted government through the use of subversion and armed conflict.

Guerrilla Warfare: (JP1-02)

(NATO) Military and paramilitary operations conducted in enemy-held or hostile territory by irregular, predominantly indigenous forces.

The ultimate goal of an insurgency is to challenge the existing government for control of all or a portion of its territory, or force political concessions in sharing political power. When employing guerilla tactics in an insurgency, the guerillas try to actually dominate territory. This is a key element in guerilla strategy since control of territory provides the population for recruitment, a logistical base, and the ground and infrastructure for establishing a regular army.⁵⁶ Terrorism normally does not contend for actual control of territory, but uses psychological impact of their violent acts to force their will on their targets. Insurgencies require the active or tacit support of some portion of the involved population. External support such as recognition or approval from other countries or political entities can be useful to insurgents, but is not required. A terror group does not require⁵⁷ and rarely has the active support or even the sympathy of a large percentage of the population. While insurgents will frequently describe themselves as “insurgents” or “guerillas,” terrorists will not refer to themselves as “terrorists” but often describe themselves using military or political terminology (“freedom fighters,” “soldiers,” “activists”). Terrorism relies on public impact, and is therefore conscious of the advantage of avoiding the negative connotations of the term “terrorists” in identifying themselves.⁵⁸

Other differences relate to the unit size, types of arms, and types of operations. Guerillas usually fight in small organized formations such as platoon or company size or larger units,

⁵⁵ Walter Reich, ed., *Origins of Terrorism: Psychologies, Ideologies, Theologies, States of Mind*, rev. ed. (Washington: Woodrow Wilson Center Press, 1998), 16-20.

⁵⁶ Ariel Merari, “Terrorism as a Strategy of Insurgency,” *Terrorism and Political Violence*, Vol 5, No. 4 (Winter 1993): 224.

⁵⁷ Reich, *Origins of Terrorism*, 17.

⁵⁸ Hoffman, *Inside Terrorism*, 29-33.

whereas terrorists normally operate in small cells.⁵⁹ As a regional example, the *Montoneros* of Argentina during the 1970s provide an example of tenuous distinctions between terrorism and guerrilla warfare. Incidents of kidnapping high profile businessmen for ransom or assassination of government officials blurred a widening array of terrorist actions that eventually presented organized military-type operations. Cellular and compartmented groups gave way to organized unit-type structure for sophisticated attacks against military forces. One attack against an infantry regiment included *Montoneros* marshalling their force over 800 kilometers from previous urban enclaves, forming assault and support elements, conducting the attack, evacuating the force with a hijacked airplane, providing medical treatment enroute to the dispersal landing field, and vanishing among the population after landing.⁶⁰

Terrorism does not usually attempt to challenge government forces directly, but acts to change perceptions as to the effectiveness or legitimacy of the government itself. This is done

“We have the right to kill four million Americans – two million of them children.”

Suleiman abu Ghaith
Al Qaeda Spokesman

by ensuring the widest possible knowledge of the acts of terrorist violence among the target audience. Terrorists, as a rule, avoid direct confrontations with government forces. A guerilla force may have something to gain from a clash with a government combat force, such as proving that they can effectively challenge the military effectiveness of the government. Terrorists may target military or

security forces, but will not engage in an engagement resembling a “fair fight.” Terrorists use methods that neutralize the strengths of conventional forces. Bombings and mortar attacks on civilian targets where military or security personnel spend off-duty time, ambushes of undefended convoys, and assassinations of poorly protected individuals are common tactics. These types of terrorism action are a recurring dilemma of ongoing operations in Iraq.

Insurgency and guerilla warfare need not require the targeting of noncombatants, although many insurgencies consider police and security personnel, in addition to military forces, as targets in an expanded definition of combatants. There have been cases where guerillas expanded the target list to include civilians. A Vietcong directive in 1965 detailed the types of people who must be “repressed,” and stated, “The targets of repression are counterrevolutionary elements who seek to impede the revolution and work actively for the enemy and for the destruction of the revolution...Elements who actively fight against the revolution in reactionary parties such as the Vietnamese Nationalist Party, Party for a Greater Viet Nam, Personality and Labor Party, and key reactionaries in organizations and associations founded by the reactionary parties and the US imperialists and the puppet government.”⁶¹ Deliberate dehumanization and criminalization of the “enemy” in the terrorists’ perspective justifies extreme measures against anyone identified as hostile. Terrorists often expand their groups of acceptable targets and conduct operations against new targets without any warning.

⁵⁹ Merari, “Terrorism as a Strategy of Insurgency,” 224.

⁶⁰ Alan C. Lowe, “Todo o Nada: Montoneros Versus the Army: Urban Terrorism in Argentina,” ed. William G. Robertson and Lawrence A. Yates, in *Block by Block: The Challenges of Urban Operations* (Fort Leavenworth, KS: U.S. Army Command and General Staff College Press, 2003), 392-396.

⁶¹ Merari, “Terrorism as a Strategy of Insurgency,” 216.

Table 1-1 provides a comparison of the differences between guerilla warfare and terrorism, and compares these types of conflict to conventional war.⁶²

Table 1-1. Comparison of Conflict			
	Conventional War	Guerilla	Terrorism
<i>Unit Size in Battle</i>	Large (armies, corps, divisions)	Medium (platoons, companies, battalions)	Small (usually less than 10 persons)
<i>Weapons</i>	Full range of military hardware (air force, armor, artillery, etc)	Mostly infantry-type light weapons but sometimes artillery as well)	Hand guns, hand grenades, assault rifles and specialized weapons, e.g., car bombs, remote-control bombs, barometric pressure bombs
<i>Tactics</i>	Usually joint operations involving several military branches	Commando-type tactics	Specialized tactics: kidnapping, assassinations, carbombs, hijacking, barricade-hostage, etc.
<i>Targets</i>	Mostly military units, industrial and transportation infrastructure	Mostly military, police and administration staff, as well as political opponents	State symbols, political opponents and the public at large
<i>Intended Impact</i>	Physical destructions	Mainly physical attrition of the enemy	Psychological coercion
<i>Control of Territory</i>	Yes	Yes	No
<i>Uniform</i>	Wear uniform	Often wear uniform	Do not wear uniform
<i>Recognition of War Zones</i>	War limited to recognized geographical area	War limited to the country in strife	No recognized war zones. Operations carried out zones world-wide
<i>International Legality</i>	Yes, if conducted by rules	Yes, if conducted by rules	No
<i>Domestic Legality</i>	Yes	No	No

⁶² Ibid., 226.

Insurgents may use more than one form of violence to obtain their objective, and the combination of terrorism and guerilla warfare are the most common.⁶³ The situation in Iraq in the fall of 2004 is a good example of how it is often difficult to separate a terrorist from a guerilla in an insurgency. Although there are many views on the threat in Iraq, one view sorts them into four groups with different tactics and goals. These include:⁶⁴

- Iraqi nationalists, known as Former Regime Elements, fighting to reclaim secular power lost when Saddam Hussein was deposed.
- Hardcore fighters, many of which are foreign, aligned with terrorist groups who want to turn Iraq into another Afghanistan to be used as an anti-Western stronghold to export Islamic revolution to other countries.
- Conservative Iraqis who want to install an Islamic theocracy, but stay away from terror tactics.
- Ordinary criminals that are paid to conduct attacks, or who kidnap westerners and sell them to the terrorists.

Real-world events can also present situations that are vague and open to multiple interpretations for the same group. A common view of al Qaeda is that they are a transnational terrorist group. Correspondingly, al Qaeda could be defined as a global insurgency set to overthrow the current world order in regard to global economic systems and globalization. Al Qaeda does have political objectives of removing the U.S. from the Middle East to enhance their ability to overthrow “apostate” moderate Arab regimes, such as the Saudi Arabia ruling family. A long-term vision seeks to reconstitute the Caliphate. Using this religious power and the wealth of oil reserves and production, the new Caliphate could serve as a means of further spreading a form of extremist religion throughout the world.

Ultimately, the difference between insurgency and terrorism comes down to the intent of the actor. Insurgency movements and guerilla forces can adhere to international norms regarding the law of war in achieving their goals, but terrorists are by definition conducting crimes under both civil and military legal codes. Terrorists routinely claim that were they to adhere to any “law of war” or accept any constraints on the scope of their violence, it would place them at a disadvantage vis-à-vis the establishment. Since the nature of the terrorist mindset is absolutist, their goals are of paramount importance, and any limitations on a terrorist’s means to prosecute the struggle are unacceptable.⁶⁵

⁶³ Bard E. O’Neill, *Insurgency & Terrorism: Inside Modern Revolutionary Warfare* (Dulles: Brassey’s, Inc, 1990), 26.

⁶⁴ Jim Krane, “U.S. Faces Complex Insurgency in Iraq,” *Duluth News Tribune.com*, (4 October 2004); available from <http://www.duluthsuperior.com/mld/duluthsuperior/news/world/9833731.htm>; Internet; accessed 16 November 2004; and Bruce Hoffman, *Insurgency and Counterinsurgency in Iraq* (Arlington: RAND Corporation, 2004), 12-13.

⁶⁵ Hoffman, *Inside Terrorism*, 33.

Use of Terror by Nation-States: Is There a Difference?

Is there a difference between terrorism and the use of specific tactics that exploit fear and terror by authorities normally considered “legitimate”? Nations and states often resort to violence to influence segments of their population, or rely on coercive aspects of state institutions. Similar to the idea of equating any act of military force with terrorism described above, there are those who equate any use of government power or authority against any part of the population as terrorism. Suppression of a riot by law enforcement personnel may in fact expose some of the population (the rioters) to violence and fear, but with the intent to protect the larger civil order. On the other hand, abuse of the prerogative of legitimized violence by the authorities is a crime.

However, there are times when national governments will become involved in terrorism or utilize terror to accomplish the objectives of governments or individual rulers. Most often, terrorism is equated with “non-state actors” or groups that are not responsible to a sovereign government. However, internal security forces can use terror to aid in repressing dissent, and intelligence or military organizations can perform acts of terror designed to further a state’s policy or diplomatic efforts abroad.

A government that is an adversary of the United States may apply terror tactics in an effort to add depth to their engagement of U.S. forces. Repression through terror of the indigenous population would take place to prevent internal dissent and insurrection that the U.S. might exploit. Military special operations assets and state intelligence operatives could conduct terrorist operations against U.S. interests both in a theater and as far abroad as their capabilities allow. Finally, attacks against the U.S. homeland could be executed by state sponsored terrorist organizations or by paid domestic proxies. Three different ways that states can engage in the use of terror are:

- Governmental or “State” terror
- State involvement in terror
- State sponsorship of terrorism

Governmental or “State” Terror: This is sometimes referred to as “terror from above,” where a government terrorizes its own population to control or repress them. These actions usually constitute the acknowledged policy of the government, and make use of official institutions such as the judiciary, police, military, and other government agencies. Changes to legal codes permit or encourage torture, killing, or property destruction in pursuit of government policy. After assuming power, official Nazi policy was aimed at the deliberate destruction of “state enemies” and the resulting intimidation of the rest of the population. Stalin’s “purges” of the 1930s are examples of using the machinery of the state to terrorize a population. The methods he used included such actions as demonstration trials with predetermined verdicts on opponents, punishing family or friends of suspected enemies of the regime, and extra-legal use of police or military force against the population.⁶⁶

⁶⁶ *International Encyclopedia of Terrorism*, 1997 ed., s.v. “Stalin’s Great Terror.”

Saddam Hussein used chemical weapons on his own Kurdish population without any particular change or expansion of policies regarding the use of force on his own citizens. They were simply used as an act of governmental terror believed to be expedient in accomplishing Hussein's goals.

State Involvement in Terror: These are activities where government personnel carry out operations using terror tactics. These activities may be directed against other nations' interests, its own population, or private groups or individuals viewed as dangerous to the state. In many cases, these activities are terrorism under official sanction, although such authorization is rarely acknowledged openly as an official action. Historical examples include the Soviet and Iranian assassination campaigns against dissidents who had fled abroad, and Libyan and North Korean intelligence operatives downing airliners on international flights.⁶⁷

Other types of these activities are "death squads" or "war veterans" as unofficial actions taken by officials or functionaries of a regime (such as members of police or intelligence organizations) to repress or intimidate their own population. While these officials will not claim such activities and disguise their participation, information often makes clear that they are acting for the state. Keeping such activities "unofficial" permits the authorities deniability and avoids the necessity of changing legal and judicial processes to justify oppression. This is different than "pro-state" terror conducted by groups or persons with no official standing and without official encouragement. While pro-state terror may result in positive outcomes for the authorities, their employment of criminal methods and lack of official standing can result in disavowal and punishment of the terrorists, depending on the morality of the regime.

State Sponsorship of Terrorism: These activities occur when governments provide supplies, training, and other forms of support to non-state terrorist organizations. This type affiliation can be state-sponsored or state-directed. One of the most valuable types of this support is the provision of safe haven or physical basing for the terrorists' organization. Another crucial service a state sponsor can provide is false documentation, not only for personal identification (passports, internal identification documents), but also for financial transactions and weapons purchases. Other means of support are access to training facilities and expertise not readily available to groups without extensive resources. Finally, the extension of diplomatic protections and services, such as immunity from extradition, diplomatic passports, use of embassies and other protected grounds, and diplomatic pouches to transport weapons or explosives have been significant to some groups.

An example of state sponsorship is the Syrian government's support of HAMAS and Hizballah in Lebanon. Syrian resources and protection enable training establishments in the Bek'aa Valley. On a smaller, more discreet scale, the East German Stasi provided support and safe-haven to members of the Red Army Faction (RAF or Baader Meinhof Gang) and neo-fascist groups that operated in West Germany.⁶⁸ Wanted members of the RAF were found resident in East Germany after the fall of the Berlin Wall in 1989.

⁶⁷ Bruce Hoffman, *Inside Terrorism* (New York: Columbia University Press, 1998), 190.

⁶⁸ Christopher C. Harmon, *Terrorism Today* (London: Frank Cass Publishers, 2000; reprint, Portland: Frank Cass Publishers, 2001), 200.

Section II: Historical Overview of Terrorism

U.S. forces need to be aware that there is a historical perspective to terrorism and that terrorists have directly targeted military personnel and facilities since the earliest times. In the 1980s, European and American radical terror groups targeted significant numbers of U.S. service members.⁶⁹ Greater involvement of U.S. military forces in terrorist related operations, either as targets or combatants, makes attacks on military personnel and facilities more likely than in the past.

Terror in Antiquity: First to Fourteenth Century A.D.

An organization that exhibited aspects of a modern terrorist organization was the Zealots of Judea. Known to the Romans as *sicarii*, or dagger-men,⁷⁰ they carried on an underground campaign of assassination of Roman occupation forces, as well as any Jews they felt had collaborated with the Romans. Their motive was an uncompromising belief that they could not remain faithful to the dictates of Judaism while living as Roman subjects. Eventually, the Zealot revolt became open, and they were finally besieged and committed mass suicide at the fortification of Masada.

The Assassins were another group characterizing terrorism. A breakaway faction of Shia Islam called the Nizari Ismalis adopted the tactic of assassination of enemy leaders because the cult's limited manpower prevented open combat.⁷¹ Their leader, Hassam-I Sabbah, based the cult in the mountains of Northern Iran. Their tactic of sending a lone assassin to successfully kill a key opposition leader at the certain sacrifice of his own life inspired fearful awe in their enemies.

The word "Assassin" was brought back to Europe by the Crusaders, and refers to the widespread rumor that the Nizari used hashish to produce the fanatical courage their lone knife-wielding killers repeatedly demonstrated.

Even though both the Zealots and the Assassins operated in antiquity, they are relevant today: aspects of motivation, organization, targeting, and goals can be compared with contemporary threats. Whether historical or contemporary incidents, both demonstrate the deep psychological impact terrorism can cause.

Early Origins of Terrorism: Fourteenth to Eighteenth Century

From the time of the Assassins (late thirteenth century) to the eighteenth century, terror and barbarism were used widely in warfare and conflict.⁷² Until the rise of the modern Western nation state after the Treaty of Westphalia in 1648, the sort of central authority and cohesive society that terrorism attempts to influence barely existed. Communications were inadequate and controlled, and the causes that might inspire terrorism (religious schism, insurrection, ethnic strife) typically led to open warfare. By the time kingdoms and principalities

⁶⁹ *International Encyclopedia of Terrorism*, 1997 ed., s.v. "Chronology of Terrorist Events."

⁷⁰ Franklin L. Ford, *Political Murder: From Tyrannicide to Terrorism* (Cambridge: Harvard University Press, 1985), 91.

⁷¹ *International Encyclopedia of Terrorism*, 1997 ed., s.v. "The Assassins: A Terror Cult."

⁷² Caleb Carr, *The Lessons of Terror: A History of Warfare Against Civilians: Why it has Always Failed and Why it will Fail Again* (New York: Random House, 2002), 52-63.

became nations, they had sufficient means to enforce their authority and suppress activities such as terrorism.

The French Revolution provided the first uses of the words “Terrorist” and “Terrorism.” Use of the word “terrorism” began in 1795 in reference to the Reign of Terror initiated by the Revolutionary government. The agents of the Committee of Public Safety and the National Convention that enforced the policies of “The Terror” were referred to as “Terrorists.” The French Revolution provided an example to future states in oppressing their populations. It also inspired a reaction by royalists and other opponents of the Revolution who employed terrorist tactics such as assassination and intimidation in resistance to the Revolutionary agents.⁷³ The Parisian mobs played a critical role at key points before, during, and after the Revolution. Such extra-legal activities as killing prominent officials and aristocrats in gruesome spectacles started long before the guillotine was first used.⁷⁴

Entering the Modern Era: The Nineteenth Century

During the late nineteenth century, radical political theories and improvements in weapons technology spurred the formation of small groups of revolutionaries who effectively attacked nation-states. Anarchists espousing belief in the “propaganda of the deed” produced some striking successes, assassinating heads of state from Russia, France, Spain, Italy, and the United States. However, their lack of organization and refusal to cooperate with other social movements in political efforts rendered anarchists ineffective as a political movement. In contrast, Communism’s role as an ideological basis for political terrorism was just beginning, and would become much more significant in the twentieth century.

“Propaganda of the Deed”

“Acts of revolution, resistance, or violence that will inspire the masses to act. It assumes that there is an untapped force of revolutionary will in the population at large.”

Another trend in the late nineteenth century was the increasing tide of nationalism throughout Europe, in which the nation (the identity of a people) and the political state were combined. As states began to emphasize national identities, peoples that had been conquered or colonized could, like the Jews at the times of the Zealots, opt for assimilation or struggle.

A prominent nationalist conflict from this time is still unresolved – the multi-century struggle of Irish nationalism. Nationalism, like communism, became a much greater worldwide and ideological force in the twentieth century. The terrorist group from this period that serves as a model in many ways for what was to come was the Russian Narodnya Volya (Peoples Will).⁷⁵ This group displayed many of the traits of terrorism organization and conduct: clandestine, cellular, impatient and unable to organize the constituents they claimed to represent; and a tendency to increase the level of violence as pressures on the group mounted. However, they would sometimes call off attacks that might endanger individuals other than their intended target. Today, there are still many terrorist organizations that attempt to prevent collateral

⁷³ *International Encyclopedia of Terrorism*, 1997 ed., s.v. “Terror in the French Revolution 1789-1815.”

⁷⁴ Simon Schama, *Citizens: A Chronicle of The French Revolution* (New York: Alfred A. Knopf, Inc., 1989), 405 & 447.

⁷⁵ *International Encyclopedia of Terrorism*, 1997 ed., s.v. “Russian Anarchist Terror.”

casualties in their operations. Unfortunately, many terrorist organizations appear to use indiscriminate levels of violence as an effective technique to achieve notoriety and media attention.

The Early Twentieth Century

The first half of the twentieth century saw two events that influenced the nature of conflict to the present day. The effects of two World Wars inflamed passions and hopes of nationalists throughout the world, and severely damaged the legitimacy of some international order and governments.

Damaged Legitimacy

The total war practices of WWII provided further justification, in some people's viewpoints, of an "everybody does it" use of terror and violations of the law of war. The desensitization of people and communities to violence that started in World War I accelerated during World War II. The intensity of the conflict between starkly opposed ideologies led to excesses on the part of many participants. New weapons and strategies that targeted the enemies' civilian population to destroy their economic capacity for conflict exposed virtually every civilian to the hazards of combatants. The major powers' support of partisan and resistance organizations using terrorist tactics was viewed as an acceptance of their legitimacy. It seemed that civilians had become legitimate targets, despite any rules forbidding it.⁷⁶

Nationalism on the Rise

Nationalism intensified during the mid to late twentieth century throughout the world. It became an especially powerful force in the subject peoples of various colonial empires. Although dissent and resistance were common in many colonial possessions, results could be achieved sometimes through dedicated nonviolence, such as in India. Other examples against colonialism witnessed terrorism as a specific program of nationalist movements. In open warfare, nationalist identities became a focal point for these actions. Gradually, as nations became closely tied to concepts of race and ethnicity, international political developments began to support such concepts. Members of ethnic groups whose states had been absorbed by others or had ceased to exist as separate nations saw opportunities to realize nationalist ambitions. Several of these groups chose terror as a method to conduct their struggle and make their situation known to world powers they hoped would be sympathetic. In Europe, both the Irish and the Macedonians had existing terrorist campaigns as part of their ongoing struggle for independence, but had to initiate bloody uprisings to further their cause. The Irish were partially successful, the Macedonians failed.

The Later Twentieth Century

Cold War Developments

The bi-polar world of the Cold War changed perception of conflicts throughout the world. Relatively minor confrontations took on significance as arenas where the superpowers could

⁷⁶ Martin L. Van Creveld, *The Transformation of War* (New York: The Free Press, 1991), 79.

compete without risking escalation to full nuclear war. Conflict in the form of “proxy wars” between the East and the West took place on the peripheries, and was limited in scope to prevent escalation. During the immediate postwar period, terrorism was more of a tactical choice by leaders of nationalist insurgencies and revolutions.

Successful campaigns for independence from colonial rule occurred throughout the world, and many employed terrorism as a supporting tactic. When terrorism was used, it was used within the framework of larger movements, and coordinated with political, social, and military action. Even when terrorism came to dominate other aspects of a nationalist struggle, such as the Palestinian campaign against Israel, or the Jewish campaign against the British, psychological stress and eroding an opponent’s resolve remained significant objectives in support of principal aims.

Throughout the Cold War, the Soviet Union provided direct and indirect assistance to revolutionary movements around the world. Many anti-colonial movements found the revolutionary extremism of communism attractive. Leaders of these “wars of national liberation” saw the advantage of free weapons and training. They also realized that the assistance and patronage of the Eastern Bloc meant increased international legitimacy. Many of these organizations and individuals utilized terrorism in support of their political and military objectives. The policy of the Soviet Union to support revolutionary struggles everywhere, and to export revolution to non-communist countries, provided extremists willing to employ violence and terror as the means to realize their ambitions.

The Internationalization of Terror

The age of modern terrorism might be said to have begun in 1968 when the Popular Front for the Liberation of Palestine (PFLP) hijacked an El Al airliner en route from Tel Aviv to Rome. While hijackings of airliners had occurred before, this was the first time that the nationality of the carrier (Israeli) and its symbolic value was a specific operational aim. Also a first was the deliberate use of the passengers as hostages for demands made publicly against the Israeli government. The combination of these unique events, added to the international scope of the operation, gained significant media attention. The founder of PFLP, Dr. George Habash observed that the level of coverage was tremendously greater than battles with Israeli soldiers in their previous area of operations. In a 1970 interview, Habash stated that although his cause did not receive much media coverage prior to the highjacking, “At least the world is talking about us now.”⁷⁷ Following the El Al highjacking, international real-time notoriety became more the norm. The 1970 PFLP destruction of a passenger aircraft, with passengers already removed, was presented on live international television. However, probably the most well known terrorist incident that propelled a cause from obscurity to the international stage was the murder of Israeli athletes by Palestinian terrorists during the Munich Olympics in 1972.

Another aspect of this internationalization is the cooperation between extremist organizations in conducting terrorist operations. Cooperative training between Palestinian groups and European radicals started as early as 1970, and joint operations between the PFLP and the Japanese Red Army (JRA) began in 1974. Since then international terrorist cooperation in training, operations, and support has continued to grow, and continues to this day. Motives

⁷⁷ Bruce Hoffman, *Inside Terrorism* (New York: Columbia University Press, 1998), 70.

range from the ideological, such as the 1980s alliance of the Western European Marxist-oriented groups, to financial, as when the IRA exported its expertise in bomb making as far reaching as Colombia. To highlight a recent historical snapshot of international nature of terrorism, Chart 1-1 depicts the number of international terrorist incidents by region for 1997 through 2003, and Chart 1-2 shows the number of casualties by region over the same timeframe.⁷⁸

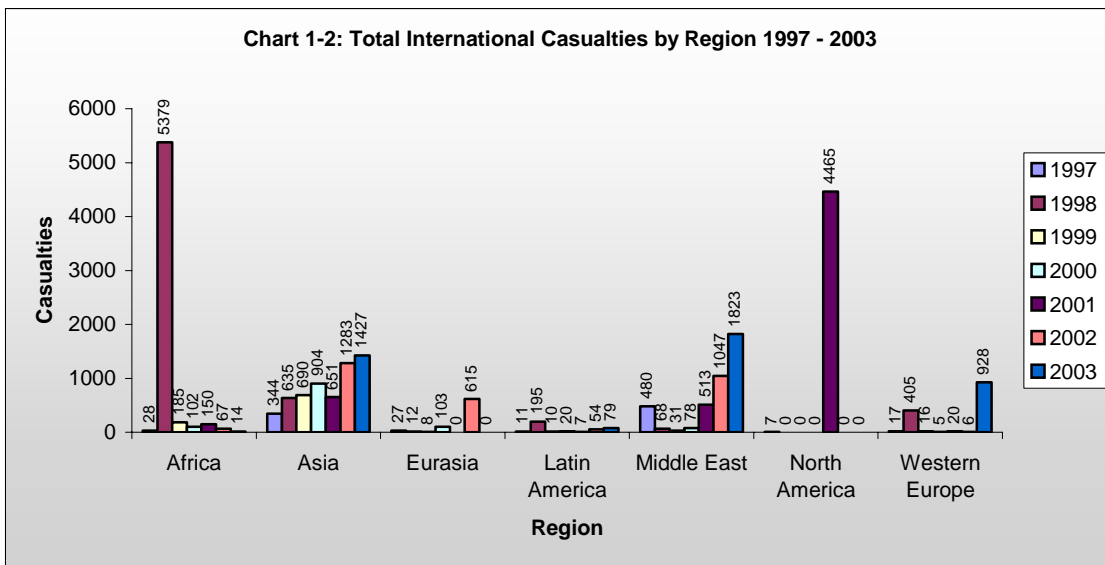
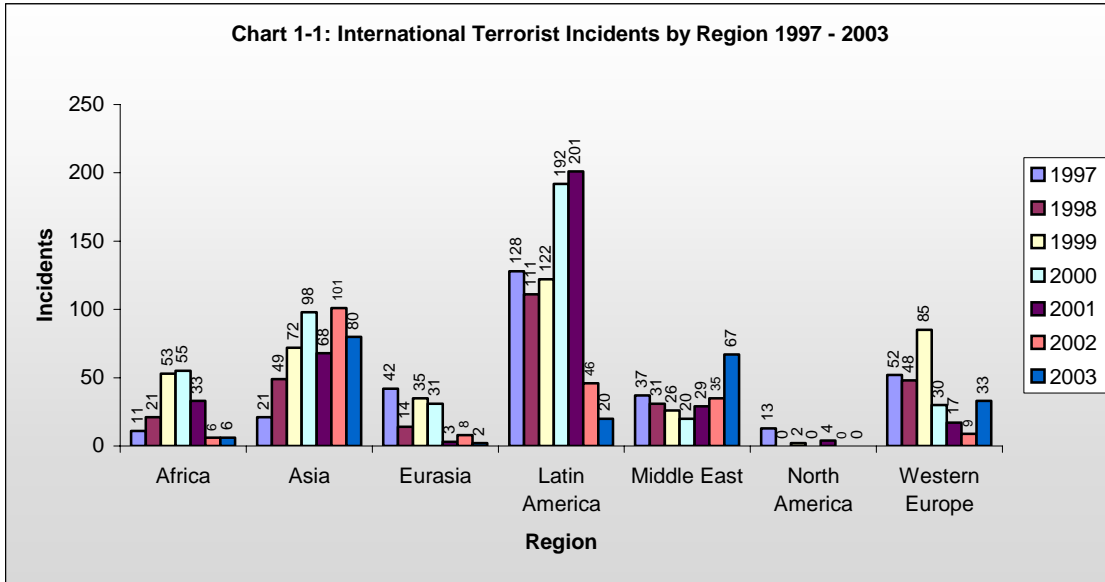

⁷⁸ Department of State, Office of the Coordinator for Counterterrorism, *Patterns of Global Terrorism 2003* (Washington, D.C., April 2004, revised 22 June 2004), 177-178; and *Patterns of Global Terrorism 2002* (Washington, D.C., April 2003), 162-163.

This internationalization of terrorism has had a direct impact on the United States. Figures 1-1 through 1-4 reflect what the U.S. Department of State, Bureau of Public Affairs considers significant terrorist incidents from 1970 through the end of 2003

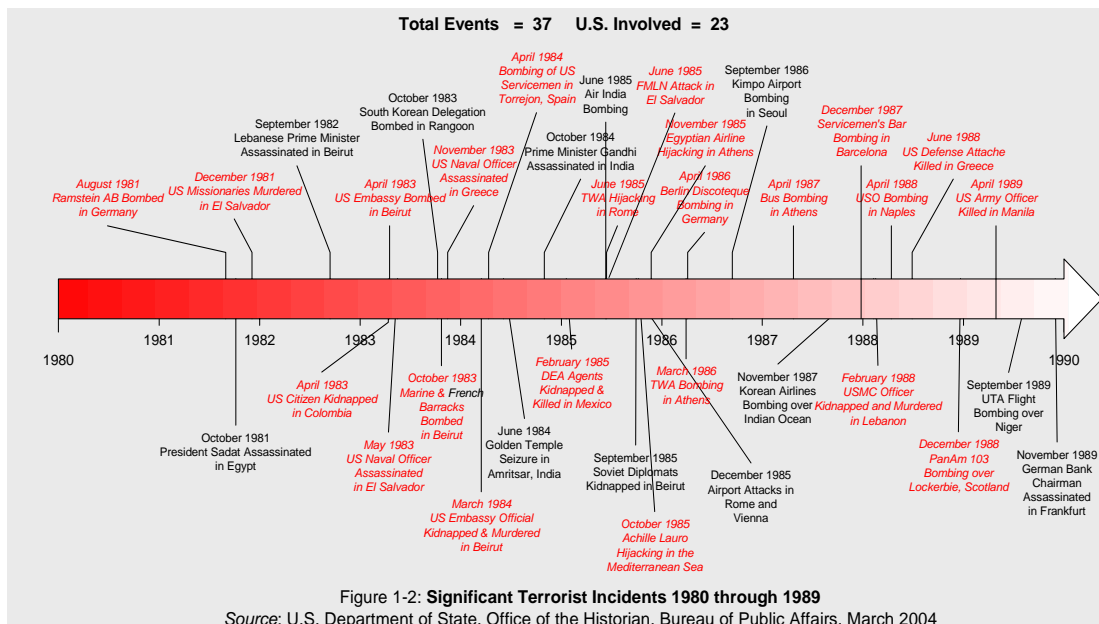
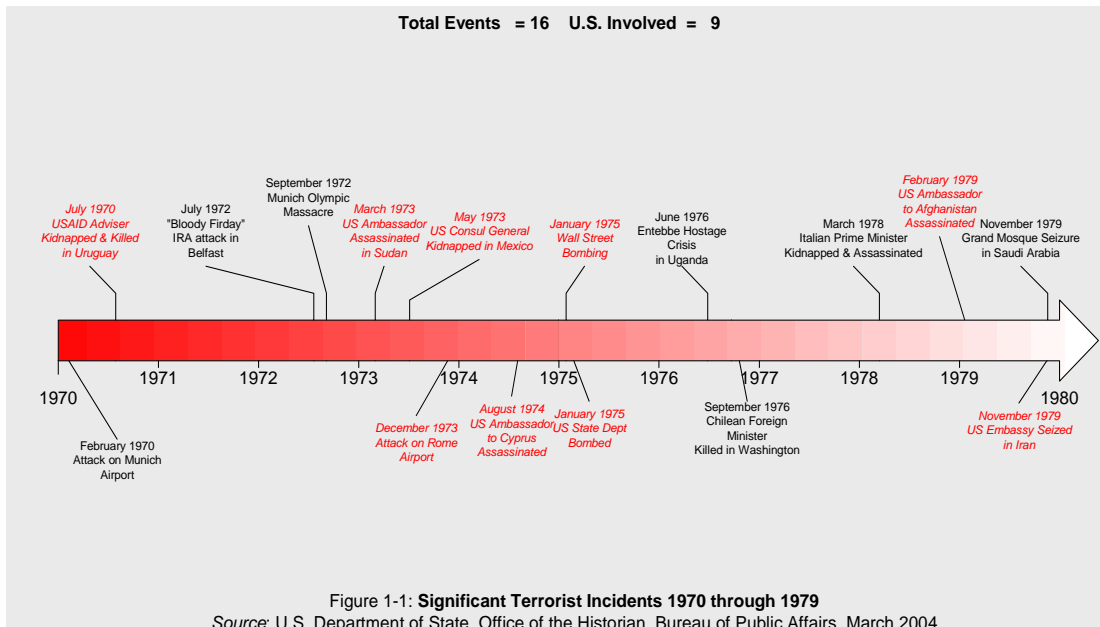

There were 16 significant events in the decade of the 1970s, with 9 of those events involving the United States or its citizens in some fashion. The decade of the 1990s shows an increase in total incidents of nearly 500% over that of the 1970s, and an increase of 644% in incidents involving the United States. In just the first four years of the decade of the 2000s, there was

an increase of 750% over that of the 1970s in overall terrorist incidents, and an increase of 411% in incidents involving the United States.⁷⁹ (Incidents in *red/italics* involve the U.S.)

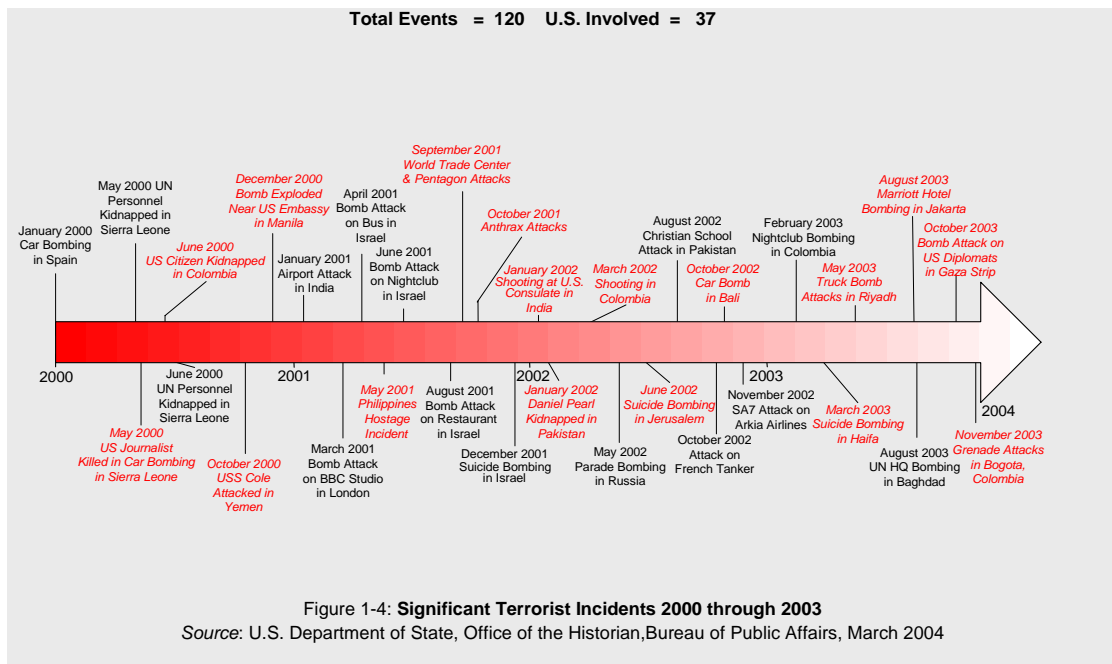
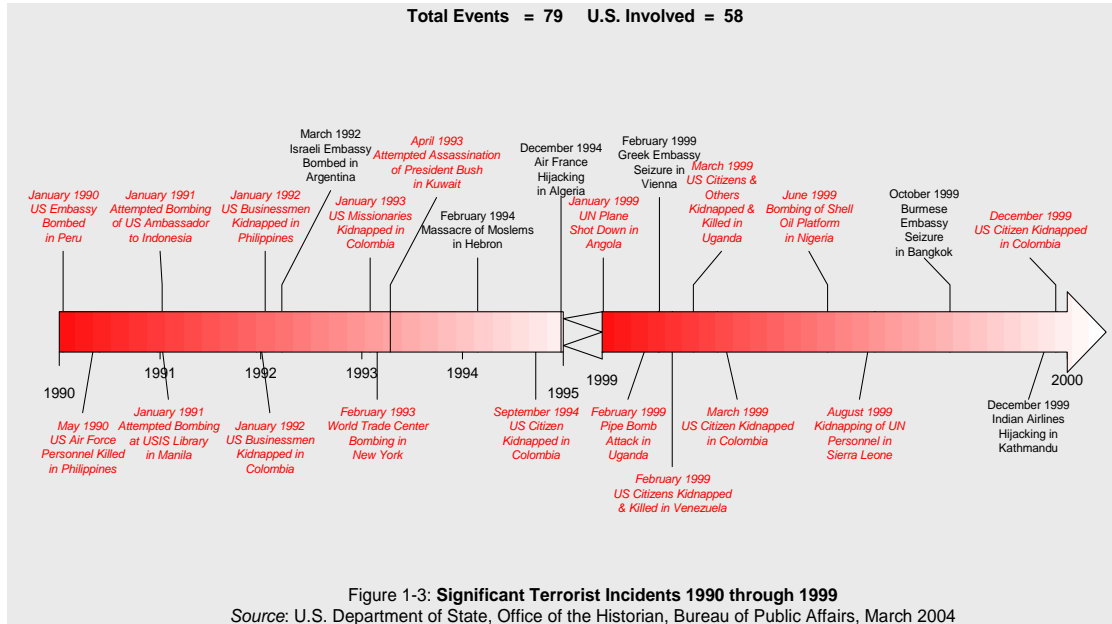

⁷⁹ Department of State, Office of the Historian, Bureau of Public Affairs, *Significant Terrorist Incidents, 1961-2003: A Brief Chronology* (Washington, D.C., March 2004), 1-19; available from <http://www.state.gov/r/pa/ho/pubs/fs/5902pf.htm>; Internet; accessed 19 April 2004.

Chart 1-3 consolidates the data from Figures 1-1 through 1-4 and reflects the growing trend of terrorist incidents since the 1970s. If you project out the actual statistics for the first 4 years of the decade of the 2000s to the end of December 2009, the total number of terrorist incidents for this first decade of the twenty-first century would be 300, with 92 of them involving the United States.

State Sponsorship of Terrorism

State sponsorship of the use of terror is not a strictly modern occurrence. Serbian intelligence officers provided support to the assassins who killed Arch Duke Franz Ferdinand of Austria, and precipitated World War I.⁸⁰ Germany provided arms to Irish nationalists during WW I to use against the British.⁸¹ Since then, state assistance to terrorists was used both as a means of surrogate warfare between states, and also as an international diplomatic tool. State sponsorship renders terrorism decidedly more effective. Access to a government’s resources of weapons, information, money, and expertise, and use of its privileges in diplomatic travel, transportation, and protection made identifiable state sponsored acts eight times as lethal in the 1980s than non-state attacks. State sponsorship also increases lethality by reducing the need for support from constituent populations, leaving the terrorist free to operate without fear of backlash due to excessive violence.⁸² The low cost and deniability of this technique has led to its adoption by nations with ambitious foreign policy goals and limited means.

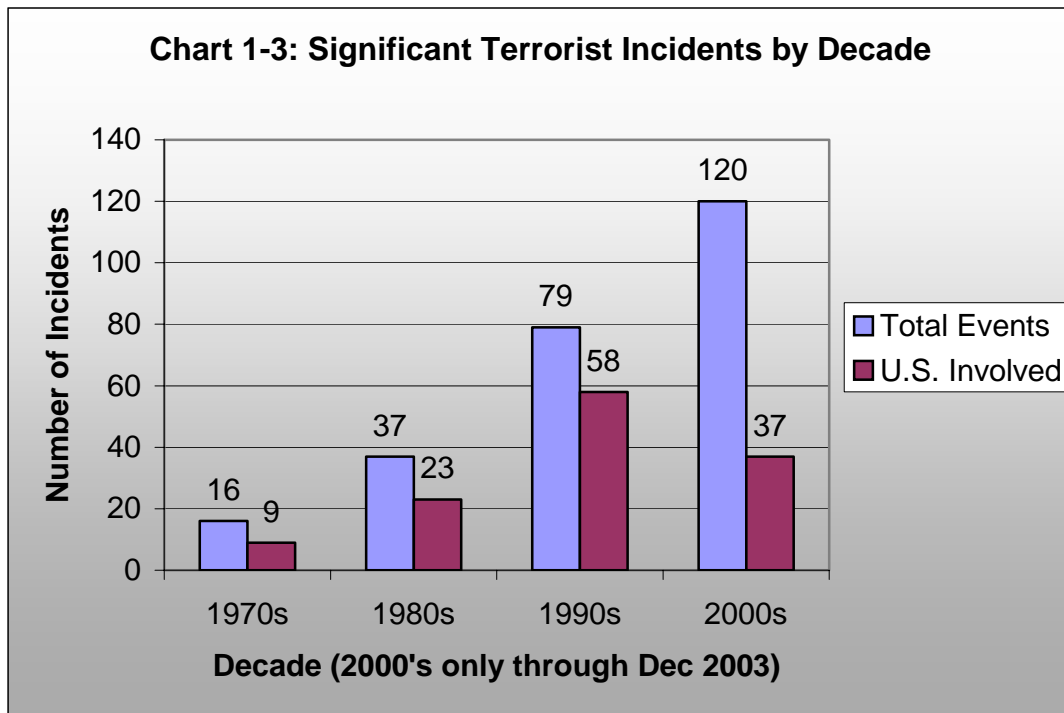

⁸⁰ *International Encyclopedia of Terrorism*, 1997 ed., s.v. “Assassination at Sarajevo 1914.”

⁸¹ *Ibid.*, s.v. “State Sponsored Terrorism.”

⁸² Bruce Hoffman, *Inside Terrorism* (New York: Columbia University Press, 1998), 189.

During the 1970s and 1980s, the Soviet Union provided significant assistance to a wide variety of organizations and individuals involved in terrorism. Attempts to destabilize governments through the use of sponsored terrorist groups to some extent replaced “wars of national liberation” as a method of the Soviet Union during this period.⁸³ Although the USSR officially denounced terrorism, it provided support directly and via surrogates. Commonly, training in revolutionary theory and practical skills were provided to promising individuals from other countries, some of whom the KGB or GRU recruited for intelligence service. Safe havens were provided for members of terrorist groups in East bloc countries such as East Germany and Czechoslovakia. Weapons and explosives were given to radical regimes such as Libya, with the knowledge that they would likely end up in the hands of terrorist groups.

The example provided by the Soviet experience led other countries to adopt state sponsorship. Ranging from tenuous diplomatic support internationally, to direct operational control of a terrorist organization, state involvement in terror can be a flexible, low-risk tool for a variety of policy goals. Iran in particular has found sponsorship of terror to particularly suit its objective of militant Islamic revolution. The incidence of state sponsorship declined somewhat after the collapse of the Soviet Union due to isolation and retaliation on other identified state sponsors. However, this type of support shows no signs of completely going away.

Current State of Terrorism

Currently terrorism continues its process of evolution. Although future trends in terrorism are discussed in Chapter 6, we are seeing the beginning of many of those trends in current conditions. Shifts in the dominant motivations for terrorists; changes in organizational structures; and the changes in response to world developments such as the global economy and the development of information technology have altered considerably the nature and tactics of terrorism.

Changes in Dominant Ideologies

Religious ideology has replaced political and nationalist ideologies as a principal cause for terrorist groups. The critical assessments of communism after the failure of the USSR caused a specific depreciation of leftist ideologies. One practical reason was the absence of major funding from the USSR for such leftist movements. Although political and nationalist rationales still exist, religious and right wing ideologies have gained more support in recent decades. To cite one example, international terrorist groups espousing religious ideologies went from three percent of total international terror groups in 1980, to forty six percent of international groups by 1995.⁸⁴ And the trend is accelerating. Also, the emergence of “single issue” movements, limited to a single concern such as environmentalism or anti-globalization, has started to supplant revolutionary ideology.

For many of the social revolutionaries, the failure of the Soviet Union, and of virtually all of the Eastern bloc communist governments, severely discredited Marxist-Leninist ideologies. The loss of supportive governments also impacted the viability of the left-wing groups in Europe. Also, nationalist movements that might have previously turned to terrorism have had

⁸³ Uri Ra'anana, ed., et al., *Hydra of Carnage; International Linkages of Terrorism* (Lexington: Lexington Books, 1986), 11.

⁸⁴ Bruce Hoffman, *Inside Terrorism* (New York: Columbia University Press, 1998), 90.

success in realizing their goals in the post Cold War world. A large number of separatist movements were accorded international recognition and acceptance as the old world order shifted. Although in some areas, such as the former Yugoslavia, this process has been anything but peaceful, it has not seen long campaigns of insurgent warfare and terrorism previously associated with nationalist struggles.

Changes to Organizational Structures

In response to improvements in counter-terror capabilities, and increased cooperation between governments, terrorist groups are moving to networked organizational models, rather than hierarchical structures. Similar to the “leaderless resistance” model of the American right wing and “eco-terror” domestic groups, this decentralized organization takes advantage of uniform ideology or beliefs to guide the efforts toward the group’s goals. The huge advances made in personal communication and privacy technology have enabled this change to a networked organization. It will be discussed in Chapter 3, but features:

- Increased security, due to fewer communications, no identifiable leadership or command structures, and less required coordination between elements not directly involved in operations.
- Faster response cycles to new countermeasures and tactics.
- Increased deniability, as actions can be acknowledged or disavowed depending on the results.

Changes to Global Conditions

Information technology has provided significant increases to the operational capabilities of terrorists, and also tightened the symbiotic relationship between terrorism and the media. The spread of information technology together with the rise of globalization has enhanced the terrorist capability to communicate, collect intelligence, operate and spread its message. Terror tactics have expanded in scope, and increased in effectiveness in proportion to the development of global media and information technology. The transmission of the message has likewise become easier and more amenable to manipulation by the terrorist.

Today, terrorists are organizing themselves in more fluid ad hoc amalgamations of individuals who appear to have been brought together for a specific, “one time only” mission. Fewer barriers between countries for people and finances are intended to improve commerce, global trade, and freedom of movement, but are enabling factors for modern terrorists and contribute to the development of ad hoc, limited duration alliances and relationships.⁸⁵ These terrorist groups may emerge from obscurity to strike, and then just as suddenly disappear.

Terrorism historically flourishes in areas that are permissive. The presence in the modern world of failed states, or dysfunctional governments, has given the terrorist a replacement for state sponsorship, with few of the disadvantages. Weak governments attract criminal activity and outcast movements. Terrorist organizations, such as Hizballah in southern Lebanon,

⁸⁵ David Newman, ed., *Boundaries, Territory and Postmodernity* (Portland: Frank Cass Books, 1999), 17-20.

build popular support by providing services to the local population. In this developing relationship, terror organizations can become local power brokers, commanding more money and technical expertise than the “legitimate” government. In return for assistance from the terrorists, the government provides physical refuge and the protection the status of a sovereign government provides against retaliation and arrest.

U.S. Legal Status of Terrorist Organizations

Within the global community, there are legal categories that define terrorist organizations according to legal statutes or in relation to national or international laws. Legal categories usually define a state’s or group of states’ relation to the terrorist organization. Such a relationship may range from toleration of activities that do no harm to the state in question to proscribing membership or support of such an organization as a criminal act. In the United States, two particular legal categories are:

- DFTO (Designated Foreign Terrorist Organization); this is a political designation determined by the U.S. Department of State. Listing as a DFTO imposes legal penalties for membership, prevents travel into the U.S., and proscribes assistance and funding activities within the U.S. or by U.S. citizens.⁸⁶
- Organizations, individuals or entities identified under Executive Order 13224. 219 as of November 2002. This Executive Order imposes penalties on the specific individuals and organizations named as terrorists and supporters of terrorism. It was designed primarily as a method of disrupting terrorist financing. Since it is an Executive Order, it may be updated to reflect changing conditions.

Other countries and the United Nations have similar, if varied, legal categories of “proscribed” organizations and individuals. Inclusion of a group on such lists of legally designated groups is at the discretion of, and for the interests of, the state or organization compiling the list.

Conclusion

The intent of this chapter was to provide the reader with basic background information concerning the nature and history of terrorism. Terrorism is a particular tactic in political conflicts that is usable by individuals as well as nations. Due to its complexity it is difficult to define, but can be understood through varied combinations of description, observation, and terrorism historical review. Understanding the larger phenomenon of terror and terrorism is necessary before proceeding to the study of terrorists and their behaviors, motivations, and characteristics in Chapter 2.

Terrorism is foremost a political problem. Terminology and definition assists in determining the policy and processes to preclude, combat, or resolve acts of terrorism. To establish an appropriate national or international action plan to terrorism, action must consider aspects of

⁸⁶ Department of State, *Patterns of Global Terrorism 2001* (Washington, D.C., May 2002), 144.

terrorist activity that include political resolve and demonstration, criminal conduct, and possible links to paramilitary operations or low intensity conflict.⁸⁷

To understand terrorism, the psychological impact of terror on a target audience must be viewed as a means to an end.

⁸⁷ Long, *The Anatomy of Terrorism*, 11 and 13.

Chapter 2

Terrorist Behaviors, Motivations, and Characteristics

Terrorists and terror groups constitute the enemy in the current Global War on Terrorism the United States finds itself engaged in today. However, despite decades of study, the nature of terrorists and their behaviors are a wide ranging set of data. In addition to the difficulty in analyzing secretive, conspiratorial groups and individuals, the variety of motivations, ideologies, and behaviors involved are diverse. Common characteristics or clearly defined traits may be apparent in simplistic comparison, but significant contrasts are more the norm.

Yet, there are benefits to studying terrorist motivations and behaviors, both at the individual and group level. Observations on human nature and group dynamics under the conditions of stress, excitement, and social isolation can give insight into the causes of particular behaviors. Also, understanding the various types of motivations for particular terrorists allows assessment of stated aims against their actual intent.

This chapter is organized into three sections. The first section is a discussion of terrorist behaviors and psychology at both individual and group level. The second examines the impact of group goals and motivations on their planning and operations. The third section consists of observations of general terrorist characteristics.

Section I: Terrorist Behavior

A common view of the terrorist is usually the unpredictable, viciously irrational stereotype emphasized by media images and sensationalism. However, as our examination of the nature and history of terrorism in Chapter 1 shows, terrorism is a rationally selected tactic, employed in the pursuit of political aims. To lend some truth to the cinema stereotype, individuals or small organizations that employ terrorist tactics may not always be concerned with particular causes or avowed ideology. Some terrorists may be motivated purely by a need to be terrorists, in whatever cause suits them, or as a “gun for hire” serving a variety of causes.

This contradiction is summed up in the two most common approaches in analyzing terrorist group and individual behavior. They are:

- The psychologically compelled (sociopath or psychopath) model: This supposes that terrorists engage in terrorism because it fulfills a psychological need (not exclusively a need for violence) on their part. This terrorism treats avowed ideology and political causes, as after the fact justifications for behaviors the terrorist will commit anyway.
- The rational choice model. Terror is a tactic selected after rational consideration of the costs and benefits in order to achieve an objective. The individual chooses participation in terrorist activities by a conscious decision (although they may not know what they are getting into). While it acknowledges that individuals or groups may be predisposed to violence, this is not considered the determining factor in the choice to use or renounce terror.

Neither of these descriptions is universally applicable, with all groups or individuals conforming to one or the other. Aspects of both theories are observed in groups and individuals. As usual, the real world provides instances of both theories, and they should both be kept in mind when examining the actions of terrorists.⁸⁸

Individual Terrorist Behaviors

“An opinion can be argued with; a conviction is best shot.”

T.E. Lawrence (of Arabia)

No one profile exists for terrorists in terms of their backgrounds or personal characteristics. The differences in the origins of terrorists in terms of their society, culture, and environment preclude such a universal approach for foreign or domestic terrorists. The profiles developed for the typical West German Red Army Faction (RAF) member 15 years ago is irrelevant to predicting the nature of an Indonesian al Qaeda recruit. Trying to predicatively profile potential terrorists, even within the same culture, is a task beyond the scope of this work.

Utopian Worldview

“...the time after victory, that is not our concern ...We build the revolution, not the socialist model.”

Gudrun Ensslin, co-leader, Red Army Faction

Terrorists typically have utopian goals, regardless of whether their aims are political, social, territorial, nationalistic, or religious. This utopianism expresses itself forcefully as an extreme degree of impatience with the rest of the world that validates the terrorists' extreme methods.⁸⁹ This philosophy may be best expressed as “Tear everything up; change now and fix later.” The individual commonly perceives a crisis too urgent to be solved other than by the most extreme methods. Alternately, the perception is of a system too corrupt or ineffective to see or adopt the “solution” the terrorist expounds. This sense of desperate impatience with opposition is central to the terrorist worldview. This is true of both secular and religiously motivated terrorists, although with slightly different perspectives as to how to impose their “solutions.”

There is also a significant impractical element of associated with this utopian mindset. Although their goals often involve the transformation of society or a significant reordering of

⁸⁸ Walter Reich, ed., *Origins of Terrorism: Psychologies, Ideologies, Theologies, States of Mind*, rev. ed. (Washington: Woodrow Wilson Center Press, 1998), 3 & 30.

⁸⁹ *Ibid.*, 30.

the status quo, individual terrorists -- even the philosophical or intellectual leaders -- are often vague or uncaring as to what the future order of things will look like or how aims will be implemented. Change, and the destructive method by which change is brought about, may be much more important than the end result.

Interaction with Others

Terrorists interact within their groups with both other members and leadership. It is common for individuals forming or joining groups to adopt the “leader principle.” This amounts to unquestioning submission to the group’s authority figure. This is true of both hierarchical and networked organizations, and of large or small groups. It explains the prevalence of individual leaders of great charisma in many terrorist organizations.⁹⁰ With a predisposition to view leaders and authority figures within the group as near ideal examples, such leaders can demand tremendous sacrifices from subordinates. This type of obedience can cause internal dissension when a leader is at odds with the group, or factions arise in the organization.⁹¹

Another adaptation the individual makes is accepting an “in-group” [us against the world] mentality. This results in a presumption of automatic morality on the part of the other individual members of the group, and the purity of their cause and righteousness of their goals. The view of the wider world may be perceived as aggressively attacking or persecuting the individual and his compatriots. Thus, violence is necessary for the “self-defense” of the group and carries moral justification. In some cases, the group comes to identify completely with their use of violence, and it becomes to them the defining characteristic of their existence on both the individual and collective level. Groups in this mind-set cannot renounce violence, since it would equal renouncing their own reason for being.⁹²

De-humanization of Non-Members

“Dear animal killing scum! Hope we sliced your finger wide open and that you now die from the rat poison we smeared on the razor blade.”

Anonymous letter rigged with rat poison covered razor blades sent to 65 guide outfitters across British Columbia and Alberta from the “Justice Department” (radical animal rights group), January 1996

There is a de-humanization of all “out-group” individuals. This de-humanization permits violence to be directed indiscriminately at any target outside the group. Assuming that all those outside of the group are either enemies or neutral, terrorists are justified in attacking anyone. And since anyone outside the group is a potential enemy, circumstances can change

⁹⁰ Sabil Frances, “Uniqueness of LTTE’s Suicide Bombers,” *Institute of Peace and Conflict Studies*, Article no. 321 (4 February 2000): 1; available at <http://www.ipcs.org>; Internet; accessed 7 September 2002.

⁹¹ Walter Lacquer, *The New Terrorism: Fanaticism and the Arms of Mass Destruction* (New York: Oxford University Press, 1999), 95.

⁹² Walter Reich, ed., *Origins of Terrorism: Psychologies, Ideologies, Theologies, States of Mind*, rev. ed. (Washington: Woodrow Wilson Center Press, 1998), 38.

that permit any restraints that the terrorists might have observed to be broken in the name of expediency.

De-humanization also removes some of the onus of killing innocents. The identification of authority figures with animals makes murder a simple slaughter of inferior life. The continual picture held up to group members is that there are oppressors and oppressed; they are fighting inhuman opponents in the name of the oppressed.

This is the other aspect of de-humanization. By making “the oppressed” or “the people” an abstract concept, usually an ignorant mass, it permits the individual terrorist to claim to act on their behalf. The terrorist believes these acts further the interests of some “un-awakened” social or ethnic constituency that is too oppressed or misinformed to realize its interests. They see themselves as leading the struggle on behalf of the rest of whatever constituency they represent. This view on the part of terrorists is common to all shades of the political spectrum. It is variously identified as “the revolutionary vanguard” or “true patriots,” but involves the terrorists acting for the good of either a silent or ignorant mass that would approve of their struggle if they were free to choose or if they understood.

Lifestyle Attractions

The lifestyle of a terrorist, while not particularly appealing for members of stable societies,

"There's something about a good bomb."

Bill Ayers, Former Weather Underground Leader
in his memoir "Fugitive Days"

can provide emotional, physical and sometimes social rewards. Emotional rewards include the feelings of notoriety, power, and belonging. In some societies, there may be a sense of satisfaction in rebellion; in others there may be a perceived increase in social status or power. For some, the intense sense of belonging generated by membership in an illegal group is emotionally satisfying.⁹³ Physical rewards can include such things as money, authority, and adventure.⁹⁴ This lure can subvert other motives. Several of the more notorious terrorists of the 1970s and 1980s, such as Abu Nidal,⁹⁵ became highly specialized mercenaries, discarding their convictions and working for a variety of causes and sponsors. Abu Nidal is a *nom de guerre* for Sabri al-Banna and an international terrorist group named after its founder “Abu Nidal” – Abu Nidal Organization (ANO).⁹⁶ Sabris al-Banna rose in notoriety in the Palestine Liberation Organization (PLO) but broke away from the PLO to form his own terror organization in the mid-1970s. The group’s goals center on the destruction of the state of Israel, but the group has served as a mercenary terrorist force with connections to several

⁹³ Ibid., 34-35.

⁹⁴ Ibid., 271.

⁹⁵ Bruce Hoffman, *Inside Terrorism* (New York: Columbia University Press, 1998), 187.

⁹⁶ “Abu Nidal,” *Encyclopedia of the Orient* [database on-line]; available from http://i-cias.com/e.o/abu_nidal.htm; Internet; accessed 24 February 2004.

radical regimes including Iraq, Syria, and Libya.⁹⁷ ANO activities link to terrorist attacks in 20 countries with killing about 300 people and injuring hundreds of additional people totaling estimates of about 900 victims.⁹⁸

Lifestyle attractions also include a sense of elitism, and a feeling of freedom from societal mores. “Nothing in my life had ever been this exciting!” enthused Susan Stern, member of the Weather Underground, describing her involvement with the group.⁹⁹

Behaviors Within Organizations

People within groups have different behaviors collectively than they do as individuals. This is as true of terrorists as it is of audiences at concerts or members of book clubs. Terrorist organizations have varying motives and reasons for existence, and how the group interprets these guides or determines internal group dynamics.

Groups are collectively more daring and ruthless than the individual members. No individual wishes to appear less committed than the others, and will not object to proposals within the group they would never entertain as an individual.¹⁰⁰ Leaders will not risk being seen as timid, for fear of losing their influence over the group. The end result can be actions not in keeping with individual behavior patterns as far as risk and lethality, but dictated by the pressure of group expectations and suppression of dissent and caution.

Group commitment stresses secrecy and loyalty to the group. Disagreements are discouraged by the sense of the external threat represented by the outside world, and pressure to conform to the group view. Excommunication from the group adds to the group’s loathing and hatred of doubters or deserters.¹⁰¹ Even the slightest suspicion of disloyalty can result in torture and murder of the suspect. The ideological intensity that makes terrorists such formidable enemies often turns upon itself, and some groups have purged themselves so effectively that they almost ceased to exist.¹⁰² Frequently, the existence of the group becomes more important than the goal they originally embraced. If the group nears success, it will often adjust objectives so as to have a reason for continued existence. In some cases, success can mean

Motivation for Destruction

Committing destructive acts for purely personal gratification is not confined to the alienation present in modern society. The Temple of Artemis at Ephesus was one of the ancient world’s most famous buildings. It was renowned both for the richness of the furnishings and the splendor of the architecture. However, because of this fame, it became a target for an individual whose contribution to world history was self-aggrandizing destruction. Herostratus destroyed the Temple in 356 B.C.E., allegedly stating that the name of the man who had built it would be lost to history, but that the name of the man who destroyed such a wonder would live forever.

⁹⁷ “Abu Nidal Organization,” *Terrorism Questions and Answers* [database on-line]; available from <http://cfrterrorism.org/groups/abunidal.html>; Internet; accessed 24 February 2004.

⁹⁸ “Abu Nidal Organization (ANO),” *FAS Intelligence Resource Program* [database on-line]; available from <http://www.fas.org/irp/world/para/ano.htm>; Internet, accessed 24 February 2004.

⁹⁹ Bruce Hoffman, *Inside Terrorism* (New York: Columbia University Press, 1998), 176.

¹⁰⁰ Walter Reich, ed., *Origins of Terrorism: Psychologies, Ideologies, Theologies, States of Mind*, rev. ed. (Washington: Woodrow Wilson Center Press, 1998), 36.

¹⁰¹ David C. Rapoport, ed., *Inside Terrorist Organizations* (New York: Columbia University Press, 1988), 157.

¹⁰² Christopher C. Harmon, *Terrorism Today* (London: Frank Cass Publishers, 2000; reprint, Portland: Frank Cass Publishers, 2001), 213.

disbanding the organization, an option to be rejected by individuals or factions whose fundamental identity and personal worth is derived from being a terrorist. Factions that advocate keeping to the original objective will inspire bitter in-fighting and schism in the group. The resulting splinter groups or dissenting individual members are extremely volatile and run the risk of compromising the original group's purpose.

In cases where the terrorists are not tied to a particular political or social goal, groups will even adopt a new cause if the original one is resolved. When first formed, many of the Euro-terror groups such as the Red Army Faction (Germany) and Communist Combatant Cells (Belgium) grew out of the 1960s student protest movement. The initial motivations for their actions were supposedly to protest U.S. involvement in Vietnam and support the North Vietnamese government. When American involvement in Vietnam came to an end, the radical left in Europe embraced Palestinian and pro-Arab causes rather than disband. Later, they conducted attacks against research facilities supporting the U.S. Strategic Defense Initiative, and to prevent deployment of the Pershing IRBM (Intermediate Range Ballistic Missile) in Germany. These examples of liberal, very left-wing viewpoints illustrate that groups can align themselves with causes in keeping with their own goals and the way they visualize group value.

Organizations that are experiencing difficulties may tend to increase their level of violence. This increase in violence can occur when frustration and low morale develops within the group due to lack of perceived progress or successful counter-terrorism measures that may limit freedom of action within the terrorist group. Members attempt to perform more effectively, but such organizational and cooperative impediments usually result in poor operational performance. The organization hopes that a change to more spectacular tactics or larger casualty lists will overcome the group's internal problems.¹⁰³ An example of this occurred in Kashmir in 2003. After an increase in suicide attacks, the chief military leader of India's northern command in Kashmir stated that militants were launching attacks to lift the morale of their cadres, because continued Indian army operations were killing six to eight militants a day, thus weakening the groups.¹⁰⁴

Another example of this phenomenon is the terrorist group, al Qaeda in the Arabian Peninsula. This regional arm of al Qaeda in Saudi Arabia is one of several associated sub-groups in a larger global reach terrorist organization, al Qaeda. During a 13-month period, this al Qaeda sub-group sustained a number of arrests and killings of their members, including the group's leader being killed and replaced four times. In May and June 2004, the sub-group conducted a wave of hostage taking, beheadings, and gruesome murders. An interview by *Sawt Al-Jihad*, an al Qaeda identified journal, was conducted with the commander of the Al-Quds Brigade, a subordinate unit of the group that took responsibility for the May 29, 2004 Oasis Compound attack at al-Khobar, Saudi Arabia where 22 people were killed. During this interview, the terrorist commander claimed they had either beheaded or cut the throats of

¹⁰³ Walter Reich, ed., *Origins of Terrorism: Psychologies, Ideologies, Theologies, States of Mind*, rev. ed. (Washington: Woodrow Wilson Center Press, 1998), 16.

¹⁰⁴ "Kashmir's Army Chief Fears Increased Suicide Attacks by Rebels," *South Asia Monitor*, 6 August 2003, 2; available from <http://www.southasiamonitor.org/focus/2003/july/24rebels.html>; Internet; accessed 20 April 2004.

more than 12 of the victims.¹⁰⁵ Al Qaeda in the Arabian Peninsula was also responsible for a number of other murders, including the killing of Robert Jacobs, an American employee of Vinnell Corporation, and the beheading of Paul Johnson, an American employee of Lockheed-Martin. In both of these, the terrorist group released gruesome videos of the murders.

Section II: Impact of Terrorist Goals & Motivations on Planning

Practical strategies against terrorists require consideration of the terrorist's point of view in his targeting and operations. Understanding the opponents' preferences and capabilities allows better defense and promotes an active approach to the threat. Total interdiction of all possible targets is impossible, since the defender cannot protect everything. While consistent prediction is unlikely, accurate determination of what risks are acceptable must consider the terrorists' values, particularly their estimate of the target's value, and the costs of the terrorist operation necessary to successfully hit it.

The proliferation of terrorism expertise, and the breakdown in restraint and observance of international norms allow many more groups and individuals to use terror as a viable tool¹⁰⁶ in order to achieve their goals. With more potential terror users, the U.S. will often be a terrorist target for several reasons.

There has been an increase in transnational radicalism as compared to recent historical conflicts. As the most prominent secular democracy and largest single economic, military, and political power in the world, the U.S. becomes an easy and appealing target for extremists. Additionally, since the United States declared the Global War on Terrorism, the U.S. has become the principal opponent of extremists throughout the world. Much of the current thinking and literature on terrorism developed when terrorism was closely tied to revolutionary movements and separatist movements concerned with influencing events in relation to one nation. Newer causes and ideologies, such as religion, economic concerns, or environmental issues are international, transnational, or even global in scope.

Further, the perception that the U.S. is the single most powerful nation in the world invites targeting by terror groups regardless of ideology to demonstrate their power and status. In the worldview of many terrorist groups, the perceived power and influence of the U.S. encourages targeting to force the U.S. to extract concessions from third parties (e.g., prisoner release, policy changes). Although some people may question why a comparatively small terrorist group believes it can successfully confront the United States, part of the answer lies in the Afghanistan jihad fighters and their success against the Soviet Union. Many of these Islamic fighters were persuaded that they alone had defeated the Soviet Union in Afghanistan (even though the U.S. provided substantial support) and that they could do the same to the United States.¹⁰⁷

¹⁰⁵ *Al-Qaeda in the Arabian Peninsula: Shooting, Hostage Taking, Kidnapping Wave – May/June 2004* (Alexandria: Tempest Publishing, LLC, 2004), 46-60.

¹⁰⁶ Martha Crenshaw, "The Logic of Terrorism: Terrorist Behavior as a Product of Strategic Choice," in *Origins of Terrorism: Psychologies, Ideologies, Theologies, States of Mind*, rev. ed., ed. Walter Reich (Washington: Woodrow Wilson Center Press, 1998), 14.

¹⁰⁷ Gilles Kepel, *Jihad: The Trail of Political Islam* (Cambridge: The Belknap Press of Harvard University Press): 10,17.

Another reason to expect greater use of terrorism against the U.S. is that possible competitors may feel that they cannot openly challenge or defeat the U.S. with any other technique. Nations have employed state sponsored terrorism to produce results that could not have otherwise been achieved against U.S. opposition. The current supremacy of American military power leaves adversaries with few options to challenge U.S. interests. Adding non-state groups of formidable capability and few restraints to the roster of potential adversaries of the U.S. increases the likely use of terror against our forces.

Many potential adversaries view the U.S. as particularly vulnerable to the psychological impact and uncertainties generated by terror tactics in support of other activities.¹⁰⁸ Terrorism and terror tactics have already been used against U.S. forces in support of conventional and insurgent warfare, as well as against U.S. forces during stability and peace support operations in attempts to influence policy.

“We are an instrument for the hostages... We force the Administration to put their lives above policy.”

Lesley Stahl, CBS White House correspondent
during the TWA flight 847 hostage crisis, 1985

Lessons drawn from previous uses of terror against the U.S. have led to some commonly held perceptions about the effectiveness and impact of terrorism versus the U.S. Some of these perceptions may or may not be valid, but are still widely held. Consequently, terrorist groups are likely to try to capitalize on what they may perceive as vulnerabilities. They include the beliefs that:

- The U.S. is extremely casualty averse. Any loss of life takes on significance out of proportion to the circumstances.

“We have seen in the last decade the decline of the American government and the weakness of the American soldier who is ready to wage Cold Wars and unprepared to fight long wars. This was proven in Beirut when the Marines fled after two explosions. It also proves they can run in less than 24 hours, and this was also repeated in Somalia.”

Usama bin Laden interview by ABC News’ John Miller, May 1998

- The U.S. Government policies and policy makers are overly influenced by public opinion, which in turn is particularly susceptible to the adverse psychological impact of terrorism.

¹⁰⁸ Qiao Liang and Wang Xiangsui, *Unrestricted Warfare*, trans. Department of State, American Embassy Beijing Staff Translators (Washington, D.C., 1999).

- The U.S. economic performance is perception driven, and therefore equally vulnerable to the adverse psychological impact of terrorism.

“Whoever has stolen our wealth, then we have the right to destroy their economy.”

Usama bin Laden’s “Letter to America”
Sunday November 24, 2002

- The U.S. cannot sustain long-term efforts, or exhibit public sacrifice in pursuit of difficult national goals.

“Those youths are different from your soldiers. Your problem will be how to convince your troops to fight, while our problem will be how to restrain our youths to wait for their turn in fighting and in operations.”

Usama bin Laden, “Declaration Of War Against The Americans Occupying The Land Of The Two Holy Places” August 26, 1996

The growing polarization of some domestic political issues means that the U.S. is also likely to see increased terror attacks on its own soil by a variety of “home-grown” groups. These groups may target U.S. forces either as symbols, sources of weapons and equipment, or at the behest of other terrorist groups in exchange for money or support elsewhere.

Terrorist Asset Cost versus Target Value

Despite some popular perceptions, there are finite limits to the number of terrorists in the U.S. Homeland and abroad. Terrorist groups require recruitment, preparation, and integration into the operational structure of the group. Recruits also require extensive vetting to ensure that they are not infiltrators from enemy security forces. A group’s leadership will not employ assets without serious consideration of the relationship between the cost of using (and possibly losing) the asset, and the potential benefits to the group. While some groups may have a greater supply of personnel assets than others, no group can expend them injudiciously.¹⁰⁹ Therefore terrorist operational planning focuses on economies of personnel, and balances the likelihood of losses against the value of a target and the probability of success. For example, suicide bombings are on the increase – effective target results for relatively low cost.

¹⁰⁹ Ehud Sprinzak, “Rational Fanatics,” *Foreign Policy*, no. 120 (September/October 2000): 66-73.

In any terrorist operation, extensive pre-operational surveillance and reconnaissance, exhaustive planning, and sufficient resources will be committed to the operation.¹¹⁰ The potential risk of exposure of these resources, and the demands on their time, are factored into the equation when deciding to commit to an attack.

Operational Intent of Terrorism

Terrorism is a psychological act that communicates through the medium of violence or the threat of violence. Terrorist strategies will be aimed at publicly causing damage to symbols or inspiring fear. Timing, location, and method of attacks accommodate media dissemination and ensure “newsworthiness” to maximize impact.

A terrorist operation will often have the goal of manipulating popular perceptions, and will achieve this by controlling or dictating media coverage. This control need not be overt, as terrorists analyze and exploit the dynamics of major media outlets and the pressure of the “news cycle.”¹¹¹ A terrorist attack that appears to follow this concept was the bombing of commuter trains in Madrid, Spain in March 2004. There has been much speculation as to the true objective behind these bombings. One view is that Islamic terrorists who specifically planned to influence the political process in Spain conducted the attacks. They believed that the large percentage of the Spanish population opposed the war in Iraq and would feel that the current government was responsible for the bombings, and would therefore vote for the opposition. The attacks occurred during morning rush hour just three days prior to national elections. The timing facilitated maximum casualties on the trains (killing 191 people and injuring more than 1800), plus immediate news coverage throughout the world of the carnage resulting from this terrorist attack. Although it cannot definitively be linked to the bombings, an anti-war Socialist prime minister was elected who quickly withdrew Spain’s military forces from Iraq.

In considering possible terrorist targets, recognize that a massively destructive attack launched against a target that cannot or will not attract sufficient media coverage to impact the target audience is not a viable target for terrorists. A small attack against a “media accessible” target is better than a larger one of less publicity. However, the spread of the global media makes many locations attractive targets that would not have been remotely considered thirty or forty years ago. The 1998 bombings of the American embassies in Kenya and Tanzania illustrate how these two relatively unimportant posts created a global sensation because of the media coverage. Forty years ago it would have taken days for the international news media to get still photographs and some text from these locations, making them much less attractive targets. However, with today’s modern technology, media reporters were able to provide immediate broadcast coverage of the bombings. Since the Islamist factions that conducted the attacks used religious justifications for their actions, the worldwide coverage of these attacks made it possible for these terrorists to pose as champions of a cause, even in the absence of any effective work at the grassroots level of society.¹¹² The September 11, 2001 bombing of

¹¹⁰ Rohan Gunaratna, “Suicide Terrorism: a Global Threat,” *Jane’s Intelligence Review* (20 October 2000): 1-7; available from http://www.janes.com/security/international_security/news/usscole/jir001020_1_n.shtml; Internet; accessed 7 September 2002.

¹¹¹ Bruce Hoffman, *Inside Terrorism* (New York: Columbia University Press, 1998), 136-142.

¹¹² Gilles Kepel, *Jihad: The Trail of Political Islam* (Cambridge: The Belknap Press of Harvard University Press): 320.

the World Trade Center in New York City was observed by millions of people worldwide on live television as the successive attacks occurred and sensational mass destruction followed.

Ideology and Motivation Influences on Operations

Ideology and motivation will influence the objectives of terrorist operations, especially regarding the casualty rate. Groups with secular ideologies and non-religious goals will often attempt highly selective and discriminate acts of violence to achieve a specific political aim. This often requires them to keep casualties at the minimum amount necessary to attain the objective. This is both to avoid a backlash that might severely damage the organization, and also maintain the appearance of a rational group that has legitimate grievances. By limiting their attacks they reduce the risk of undermining external political and economic support. A good illustration of a group that discriminates on target selection is the Revolutionary Organization 17 November. This is a radical leftist organization established in 1975 in Greece that is anti-Greek establishment, anti-United States, anti-Turkey, and anti-NATO. Its operations have included assassinations of senior U.S. officials, Greek public figures, European Union facilities, and foreign firms investing in Greece. Although a violent organization, reports are the group did not kill a bystander until 1992. In total, 17 November is believed to have been responsible for over 100 attacks, but just 23 fatalities between 1975 and 2000.¹¹³ Groups that comprise a “wing” of an insurgency, or are affiliated with sometimes legitimate, political organizations often operate under these constraints. The tensions caused by balancing these considerations are often a prime factor in the development of splinter groups and internal factions within these organizations.

In contrast, religiously oriented and millenarian groups typically attempt to inflict as many casualties as possible. An apocalyptic frame of reference may deem loss of life as irrelevant and encourage mass casualty producing incidents. Losses among their co-religionists are of little account, because such casualties will reap the benefits of the afterlife. Likewise, non-believers, whether they are the intended target or collateral damage, deserve death, and killing them may be considered a moral duty. The Kenyan bombing against the U.S. Embassy in 1998 inflicted casualties on the local inhabitants in proportion to U.S. personnel of over twenty to one killed, and an even greater disparity in the proportion of wounded (over 5000 Kenyans were wounded by the blast; 95% of total casualties were non-American).¹¹⁴ Fear of backlash rarely concerns these groups, as one of their goals may be to provoke overreaction by their enemies and potentially widen the conflict. In the case of the Embassy bombing in Kenya, the suicide bomber failed in his attempt to penetrate the Embassy's outer perimeter, thanks to the refusal of local guards to open the gates. This resulted in the large casualty rate amongst local Kenyans. With numerous dead and maimed Kenyans, the terrorists issued a statement attempting to qualify a rationale for the deaths and to mollify critics.

The type of target selected will often reflect motivations and ideologies. For groups professing secular political or social motivations, their targets are highly symbolic of authority; government offices, banks, national airlines, and multinational corporations with direct relation to the established order. Likewise, they conduct attacks on representative

¹¹³ “Revolutionary Organization 17 November (17N),” CDI Terrorism Project, 5 August 2002; available from <http://www.cdi.org/terrorism/17N-pr.cfm>; Internet; accessed 24 September 2004.

¹¹⁴ Christopher C. Harmon, *Terrorism Today* (London: Frank Cass Publishers, 2000; reprint, Portland: Frank Cass Publishers, 2001), 51.

individuals whom they associate with economic exploitation, social injustice, or political repression. While religious groups also use much of this symbolism, there is a trend to connect it to greater physical devastation. There also is a tendency to add religiously affiliated individuals, such as missionaries, and religious activities, such as worship services, to the targeting equation.

Another common form of symbolism utilized in terrorist targeting is striking on particular anniversaries or commemorative dates. Nationalist groups may strike to commemorate battles won or lost during a conventional struggle, whereas religious groups may strike to mark particularly appropriate observances. Many groups will attempt to commemorate anniversaries of successful operations, or the executions or deaths of notable individuals related to their particular conflict. Likewise, striking on days of particular significance to the enemy can also provide the required impact. For instance, Timothy McVeigh conducted the bombing of the Murrah Federal Building on April 19th, the anniversary of the end of the Branch Davidian siege near Waco, Texas. Since there are more events than operations, assessment of the likelihood of an attack on a commemorative date is only useful when analyzed against the operational pattern of a particular group or specific members of a group's leadership cadre.

Section III: Terrorist Characteristics

No singular personality profile of a terrorist exists, and no predictive test exists that can guarantee identification of a terrorist. Numerous terrorism-related studies have analyzed the biographical and social data on known terrorists in an attempt to develop some form of terrorist profile. Studies have shown that in general, terrorists are people who often feel alienated from society and have a grievance or regard themselves as victims of an injustice. They are devoted to their political or religious cause and do not regard their violent actions as criminal, showing no pity or remorse for their actions. Although their level of sophistication will vary depending on the individual and the specific terrorist group, terrorists are people who are skillful and ruthless in conducting terrorist acts.¹¹⁵ In addition to the above traits, there are some general characteristics that are fairly common among terrorists. There are also some common stereotypes and misperceptions regarding terrorists.

Status

Contrary to the oft-repeated charge that terrorism is a product of poverty and despair, terrorists are most commonly from middle class backgrounds, with some actually coming from extreme wealth and privilege. While guerilla fighters and gang members often come from poor and disadvantaged backgrounds, and may adopt terrorism as a tactic, terrorist groups that specifically organize as such generally come from middle and upper social and economic strata. Marc Sageman, a Senior Fellow at PFRI and a former CIA case officer in Afghanistan, conducted a study of 400 Islamic terrorists. He found that 75% came from the upper or middle class and 90% came from caring, intact families.¹¹⁶ The leadership may use less educated and socially dispossessed people to conduct acts of terrorism. Even in terrorist

¹¹⁵ Rex A. Hudson, *The Sociology and Psychology of Terrorism: Who Becomes a Terrorist and Why?* (Washington: Library of Congress Federal Research Division, 1999), 50.

¹¹⁶ Marc Sageman, "Understanding Terror Networks," 3.

groups that espouse the virtues of “the people” or “the proletariat,” leadership consists primarily of those of middle class backgrounds. However, this characteristic must be considered in context with the society the terrorist originates from. “Middle class” or “privilege” are relative terms and will, for example, mean completely different levels of income between Western Africa and Western Europe.

Education and Intellect

Terrorists in general have more than average education, and very few Western terrorists are uneducated or illiterate.¹¹⁷ Some leaders of larger terrorist organizations may have minimal education, but this characteristic is not the norm. Left wing terrorists, international terrorists, and the leadership echelon of right wing groups are usually of average or better intelligence, and have been exposed to advanced education. In fact, terrorist groups are increasingly recruiting members with expertise in areas such as communications, computer programming, engineering, finance, and the sciences.¹¹⁸ The Sageman analysis reflected 63% of his group had gone to college and three-quarters were professionals or semi-professionals.¹¹⁹ (Usama bin Laden a civil engineer; Ayman Zawahiri a physician; and Yasir Arafat was at one time a civil engineer.) These terrorists generally have had exposure to higher learning, although they are usually not highly intellectual, and are frequently dropouts or possess poor academic records. Again, this is subject to the norms of the society they originate from. In societies where religious fundamentalism is prevalent, the higher education may have been advanced religious training.¹²⁰

Domestic and right wing terrorists tend to come from lower educational and social levels, although they are not uneducated. It was right wing domestic groups in the U.S. that first explored the communication and organizational potential of the Internet. They will typically have received a high school level education, and be very well indoctrinated in the ideological arguments they support.

Age

Terrorists tend to be young. Leadership, support, and training cadres can range into the 40-50 year old age groups, but most operational members of terrorist organizations are in the 20-35 year old age group.¹²¹ The amount of practical experience and training that contributes to making an effective operative is not usually present in individuals younger than the early 20s. Individuals in their teens have been employed as soldiers in guerilla groups, but terrorist organizations do not tend to accept extremely young members, although they will use them as non-operational supporters. Groups that utilize suicide operations will employ very young individuals as suicide assets, but these youths are not actually members of the organization, but simply exploited or coerced into an operational role.¹²² Many countries in the developing

¹¹⁷ Rex A. Hudson, *The Sociology and Psychology of Terrorism: Who Becomes a Terrorist and Why?*, 48.

¹¹⁸ *Ibid.*, 4.

¹¹⁹ Marc Sageman, “Understanding Terror Networks,” 3.

¹²⁰ Christopher C. Harmon, *Terrorism Today* (London: Frank Cass Publishers, 2000; reprint, Portland: Frank Cass Publishers, 2001), 208.

¹²¹ Walter Lacquer, *The New Terrorism: Fanaticism and the Arms of Mass Destruction* (New York: Oxford University Press, 1999), 38.

¹²² Walter Reich, ed., *Origins of Terrorism: Psychologies, Ideologies, Theologies, States of Mind*, rev. ed. (Washington: Woodrow Wilson Center Press, 1998), 270.

world subjected to ethnic, political, and religious violence; however, are seeing younger members being recruited by terrorist organizations. Pre-teens and adolescents are often receptive to terrorist recruiting because they have witnessed killings and see violence as the only way to deal with grievances.¹²³ An example is the Liberation Tigers of Tamil Eelam (LTTE) in Sri Lanka. They have recruited children to offset a manpower shortage due to casualties. Assessments by the Sri Lankan Directorate of Military Intelligence indicate a large percentage of fighters are below 18 years of age.¹²⁴

Gender

Terrorists are not exclusively male, even in groups that are rigorously Islamic. Women's roles in these groups will often be constrained to support or intelligence work, but some fundamentalist Islamic groups use women in operational roles. In groups where religious constraints do not affect women's roles, female membership may be above fifty percent, with women fully integrated into operations. Female leadership of terrorist groups is not uncommon, and female terrorists lack for nothing in terms of violence and ruthlessness. For example, one-third of the LTTE cadre is made up of women and it is reported that nearly 4,000 have been killed since they began taking part in combat in 1985, over 100 of those killed belonging to the dreaded Black Tiger suicide squad.¹²⁵

In August 2004, female Chechen suicide bombers were responsible for detonating IEDs while on Russian commercial flights that resulted in two aircraft crashes and the death of all people on board. Within one week, another female Chechen suicide bomber detonated an IED near metro station in northeast Moscow causing extensive property damage and injuring many people in the area.¹²⁶

Again, there is an exception to this general observation in some right wing groups, particularly those with neo-Nazi and Christian Identity oriented ideologies. Female participation and leadership is much less common in these groups.

Appearance

Terrorists are often unremarkable in individual characteristics. Racial diversity in organizations such as al Qaeda signal that attempts to racially profile likely terrorist group members is not an effective indicator. They usually do not appear out of the ordinary, and are capable of normal social behavior and appearance. Over the long term, elements of fanatical behavior or ruthlessness may become evident, but they are typically not immediately obvious to casual observation. An excellent example of this is the group 17 November in Greece. When the police captured 14 suspected members in 2002, the most striking characteristic was their ordinary nature. Among the group were a schoolteacher, a shopkeeper, a telephone operator, and other members that appeared to be members of

¹²³ Rex A. Hudson, *The Sociology and Psychology of Terrorism: Who Becomes a Terrorist and Why?*, 48.

¹²⁴ "Liberation Tigers of Tamil Eelam (LTTE)," South Asia Terrorism Portal, n.d., 2; available from <http://www.satp.org/satporgrp/countries/shrilanka/terroristoutfits/Ltte.htm>; Internet; accessed 7 July 2004.

¹²⁵ *Ibid.*, 2.

¹²⁶ Billy Alfano, Briefing: "Terrorism Strikes Russia, Summary of the Attacks from August 24 to September 3, 2004," Department of state, Diplomatic Security, Overseas Security Advisory Council, International Security Specialist for Western Europe, n.d.

mainstream society.¹²⁷ Although members of sleeper cells or other covert operators may marry as part of their persona, most terrorists do not marry, even though there have been cases of married couples within terrorist organizations.

Conclusion

This chapter provided a discussion of some aspects of terrorist behavior and group dynamics. This information will allow the reader to place these behaviors in context with the descriptions of terrorist organizations in Chapter 3.

¹²⁷ “Revolutionary Organization 17 November (17N),” CDI Terrorism Project, 5 August 2002; available from <http://www.cdi.org/terrorism/17N-pr.cfm>; Internet; accessed 24 September 2004.

Page Intentionally Blank

Chapter 3

Terrorist Group Organization

This chapter examines terrorist group organization. Joint Publication 3-07.2 *Joint Tactics, Techniques, and Procedures (JTTP) for Antiterrorism* (Revised First Draft) states that, “The terrorist organization’s structure, membership, resources, and security determine its capabilities and reach.” A general knowledge of the prevalent models of terrorist organizations leads to a better understanding of their overall capabilities. Knowledge of the different labels and systems of classification that have been applied to groups and individuals aid us in discarding useless or irrelevant terms, and correctly using the commonly accepted descriptions of terrorism.

“There’s nothing wrong with being a terrorist, as long as you win.”

Paul Watson, Sea Shepard Conservation Society

Traditionally, a popular image of a terrorist group operating according to a specific political agenda and motivated by ideology or the desire for ethnic or national liberation dominated our understanding of terrorism. While still true of some terrorist organizations, this image is no longer universally valid. Also, a generational change in leadership of established groups is in many cases ushering in a more destructive and relentless type of organization.

When examining the overall structure of terrorist groups, there are two general categories of organization: networked and hierarchical. A terrorist group may employ either type or a combination of the two models. Newer groups tend towards organizing or adapting to the possibilities inherent in the network model. Ideology can have an effect on internal organization, with strict Leninist or Maoist groups tending towards centralized control and hierarchical structure. Within the larger structure, though, virtually all groups use variants of cellular organizations at the tactical level to enhance security and to organize for operations.

Terrorist groups that are associated with a political activity or organization will often require a more hierarchical structure, in order to coordinate terrorist violence with political action. It also can be necessary for a politically affiliated group to observe cease-fire agreements or avoid particular targets in support of political objectives. This can be difficult to enforce in networked organizations.

Terrorist groups can be at various stages of development in terms of capabilities and sophistication. Newer groups with fewer resources will usually be less capable, and operate in permissive areas or under the tutelage of more proficient organizations to develop proficiency. Change in terrorist leadership, whether through generational transition or as a response to enhanced security operations, may signal significant adjustments to organizational priorities and means of conducting terrorism. Also, groups professing or associated with ethnic or nationalist agendas and limiting their operations to one country or a localized region tend to require fewer capabilities. Larger groups can coalesce from smaller organizations, or smaller groups can splinter off from larger ones.

Section I: Terrorist Group Structure

Levels of Commitment

There are typically different levels of commitment within an organization: passive supporters, active supporters, cadre, and leadership. Figure 3-1 shows how each successive level of commitment has fewer members. This pyramid diagram is not intended as an organizational picture, but to show the relative number of people in each category. This image of overall density holds true for networks as well as hierarchies. Passive supporters may intermingle with active supporters and be unaware of what their actual relationship is to the organization.

- Leaders provide direction and policy; approve goals and objectives; and provide overarching guidance for operations. Usually leaders rise from within the ranks of any given organization, or create their own organization from scratch.
- Cadres are the active members of the terrorist organization. This echelon plans and conducts not only operations, but also manages areas of intelligence, finance, logistics, information operations, and communications. These activities all occur in the active membership. Mid-level cadres tend to be trainers and technicians such as bomb makers, financiers, and surveillance experts. Low-level cadres are the bombers and similar direct action terrorists in an attack.
- Active Supporters are active in the political, fund-raising, and information activities of the group. Acting as an ally or tacit partner, they may also conduct initial intelligence and surveillance activities, and provide safehaven houses, financial contributions, medical assistance, and transit assistance for active members of the organization. They are usually fully aware of their relationship to the terrorist group but do not commit violent acts.
- Passive Supporters are typically individuals or groups that are sympathetic to the announced goals and intentions of the terrorist organization, but are not committed enough to take action. They may not be aware of their precise relation to the terrorist group, and interface with a front that hides the overt connection to the terrorist group. Sometimes fear of reprisal from terrorists is a compelling factor in passive support. Sympathizers can be useful for political activities, fund raising, and unwitting or coerced assistance in intelligence gathering or other non-violent activities.

Terrorist groups will recruit from populations that are sympathetic to their goals. Often legitimate organizations can serve as recruiting grounds for terrorists. Militant Islamic recruiting, for example, is often associated with the proliferation of the radical Wahhabi sect. This recruiting is conducted on a worldwide basis via Wahhabist schools financed from both governmental and non-governmental donations and grants.¹²⁸ Some recruiting may be conducted for particular skills and qualifications, and not be tied to ideological characteristics. Of particular concern are attempts of terrorist organizations to recruit current or former members of the U.S. armed forces, both as trained operatives, and as agents in place.

¹²⁸ Victor N. Corpus, "The Invisible Army" (Briefing presented at Fort Leavenworth, KS, 5 November 2002), TRADOC ADCSINT-Threats Files, Fort Leavenworth, KS.

Recruitment can gain operatives from many diverse social backgrounds. At times, the approach to radical behavior or direct actions with terrorism can develop over the course of years or decades. One example is John Walker Lindh, the U.S. citizen captured by U.S. military forces in the war in Afghanistan. His notoriety jumped into international attention, as did the situation of individuals from several counties that were apprehended in combat actions of Afghanistan. Lindh's change from an unassuming middle-class adolescent in the Western United States to a member of a paramilitary training camp in Pakistan and subsequent support for Taliban forces in Afghanistan spotlights that general profiling should be tempered with specific instances and a broad perspective. In the case of Jose Padilla, his simple and voluntary efforts to detonate a bomb in the U.S. may illustrate al Qaeda techniques to support, finance, and use less than sophisticated means to conduct terrorist acts.

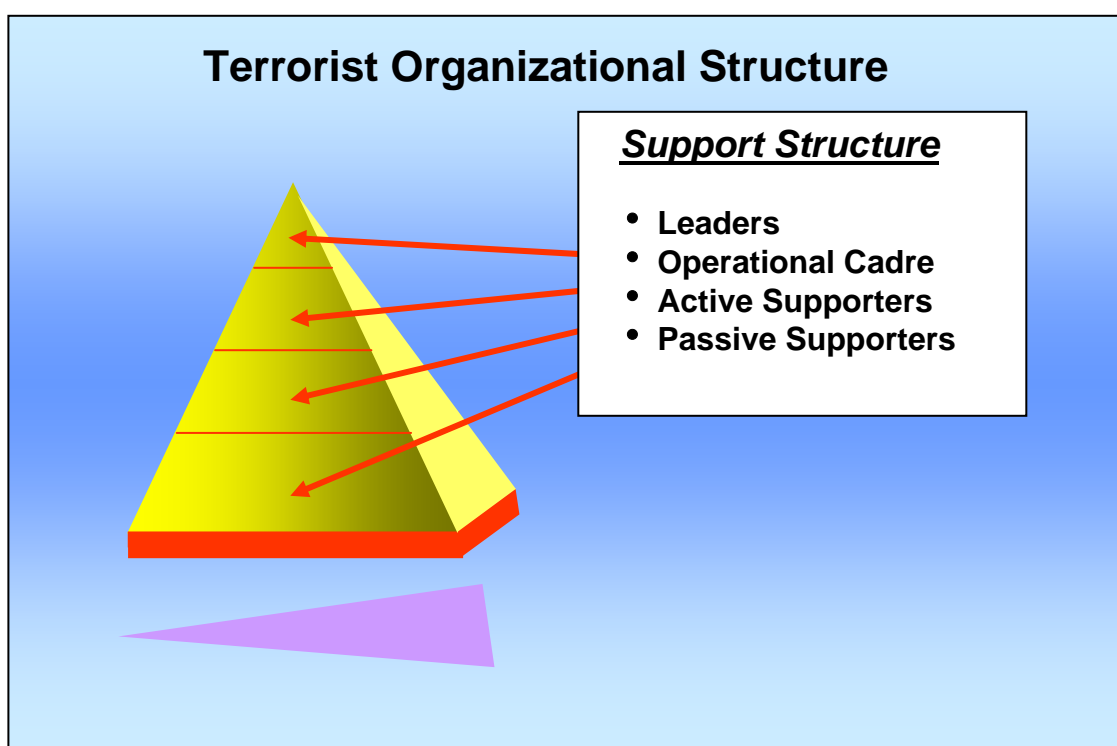

Figure 3-1. Typical Levels of Support

Some groups will also use coercion and leverage to gain limited or one-time cooperation from useful individuals. This cooperation can range anywhere from gaining information to conducting a suicide bombing operation.¹²⁹ Blackmail and intimidation are the most common forms of coercion. Threats to family members are also employed. Coercion is often directed at personnel in government security and intelligence organizations.

¹²⁹ Walter Reich, ed., *Origins of Terrorism: Psychologies, Ideologies, Theologies, States of Mind*, rev. ed. (Washington: Woodrow Wilson Center Press, 1998), 270-271.

Tactical-level Cellular Organization

The smallest elements at the tactical level of terrorist organizations are the cells that serve as building blocks for the terrorist organization. One of the primary reasons for a cellular or compartmentalized structure is security. The compromise or loss of one cell should not compromise the identity, location, or actions of other cells. A cellular organizational structure makes it difficult for an adversary to penetrate the entire organization. Personnel within one cell are often unaware of the existence of other cells and, therefore, cannot divulge sensitive information to infiltrators or captors. The home page of the Earth Liberation Front is an excellent example of this cellular organization. It states, "Modeled after the Animal Liberation Front, the E.L.F. is structured in such a way as to maximize effectiveness. By operating in cells (small groups that consist of one to several people), the security of group members is maintained. Each cell is anonymous not only to the public but also to one another. This decentralized structure helps keep activists out of jail and free to continue conducting actions."

Terrorists may organize cells based on family or employment relationships, on a geographic basis, or by specific functions such as direct action and intelligence. The terrorist group may also form multifunctional cells. The terrorist group uses the cells to control its members. Cell members remain in close contact with each other in order to provide emotional support and to prevent desertion or breach of security procedures. The cell leader is normally the only person who communicates and coordinates with higher levels and other cells.

A terrorist group may form only one cell or may form many cells that operate locally, transnationally, or internationally. The number of cells and their composition depend on the size of the terrorist group. A terrorist group operating within one country frequently has fewer cells and specialized teams than does an international terrorist group that may operate in several countries.

Group Organizational Structure

As stated earlier, there are two basic models used when examining the overall organizational structure of a terrorist group. These are the hierarchical and the networked models. A terrorist group may employ either type or a combination of the two models.

Hierarchical Structure

Hierarchical structure organizations are those that have a well-defined vertical chain of command linkage and responsibility. Data and intelligence flows up and down organizational channels that correspond to these vertical chains, but may not move horizontally through the organization. This is more traditional, and is common of groups that are well established with a command and support structure.

Hierarchical organizations feature greater specialization of functions in their subordinate cells (support, operations, intelligence). Usually, only the cell leader has knowledge of other cells or contacts, and only senior leadership has visibility of the organization at large. In the past, terrorism was practiced in this manner by identifiable organizations with a command and

control structure influenced by revolutionary theory or ideology. Radical leftist organizations such as the Japanese Red Army, the Red Army Faction in Germany, the Red Brigades in Italy, as well as ethno-nationalist terrorist movements such as the Palestine Liberation Organization, the Irish Republican Army and the Basque separatist ETA group, conformed to this stereotype of the "traditional" terrorist group. These organizations had a clearly defined set of political, social or economic objectives, and tailored aspects of their organizations (such as a "political" wing or "social welfare" group) to facilitate their success. The necessity to coordinate actions between various "fronts," some of which were political and allegedly non-violent, and the use of violence by terrorists and some insurgents, favored a strong and hierarchical authority structure.

Networked Structure

Terrorists are now increasingly part of far more indistinct and broader system of networks than previously experienced. Groups based on religious or single-issue motives lack a specific political or nationalistic agenda; they therefore have less need for a hierarchical structure to coordinate the achievement of their goals. Instead, they can depend and even thrive on loose affiliation with like-minded groups or individuals from a variety of locations. General goals and targets are announced, and individuals or cells are expected to use flexibility and initiative to conduct the necessary action.

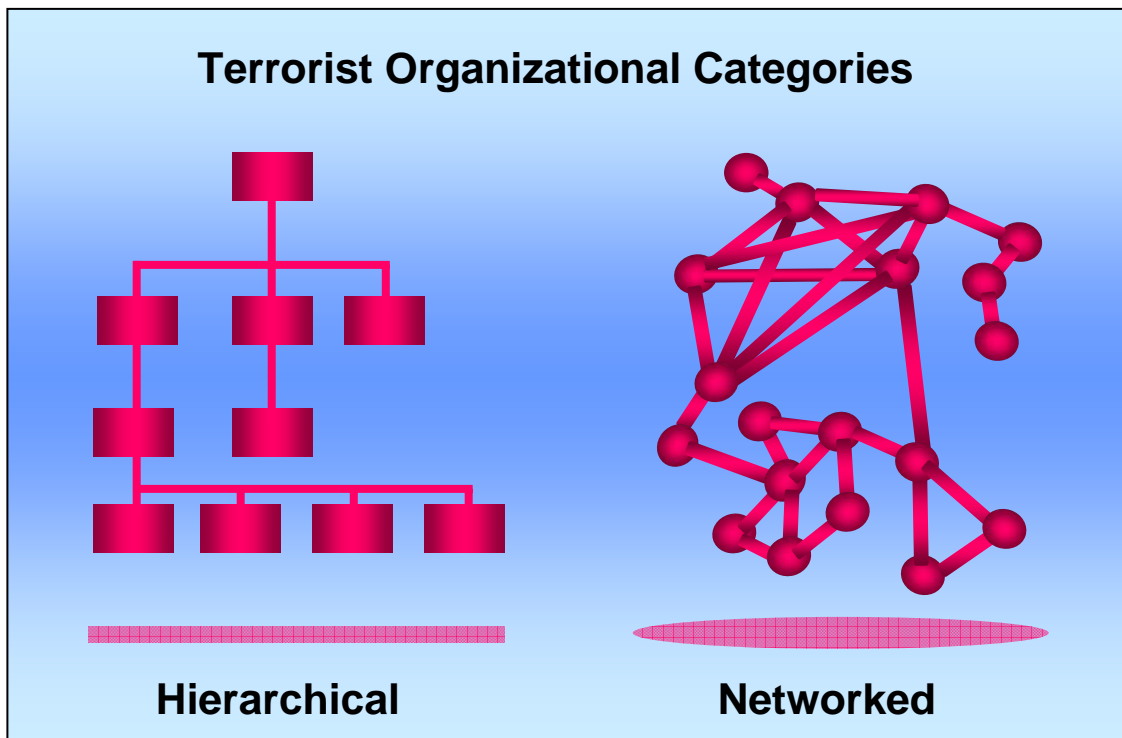

Figure 3-2. Typical Categories of Terrorist Organization

Basic Concepts.

Networks consist of nodes. A node may be an individual, a cell, another networked organization, or a hierarchical organization. They may also consist of parts of other organizations, even governments, which are acting in ways that can be exploited to achieve the network's organizational goals.

The effectiveness of a networked organization is dependent on several things. The network achieves long-term organizational effectiveness when the nodes share a unifying ideology, common goals or mutual interests.¹³⁰ When there is failure to accept the overall goals of the organization, pieces of the network will drop out. This is less catastrophic than a splintering within a hierarchical group.

Another difficulty for network organizations not sharing a unifying ideology is that nodes can pursue objectives or take actions that do not meet the goals of the organization, or are actually counterproductive. In this instance, the independence of nodes fails to develop synergy between their activities or contribute to common objectives.

Networks distribute the responsibility for operations, and provide redundancies for key functions. The various cells need not contact or coordinate with other cells except for those essential to a particular operation or function. The avoidance of unnecessary coordination or command approval for action provides deniability to the leadership and enhances operational security.

Networks are not necessarily dependent on the latest information technology for their effect. The organizational structure and the flow of information inside the organization are the defining aspects of networks. While information technology can make networks more effective, low-tech means such as couriers and landline telephones can enable networks to operate effectively in certain circumstances.

Basic Types.

There are various types of networked structure, depending on the ways in which elements are linked to other elements of the structure. There are three basic types: chain, hub, and all-channel. A terrorist group may also employ a hybrid structure that combines elements of more than one network type.

- Chain Networks

Each node links to the node next in sequence. Communication between the nodes is by passing information along the line. This organization is most common among networks that smuggle goods and people or launder money.

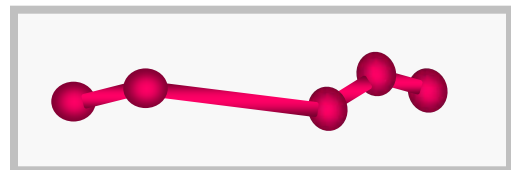

Figure 3-3. Chain Network

¹³⁰ John Arquilla and David Ronfeldt, ed., *Networks and Netwars* (Santa Monica: RAND, 2001), 9.

- Hub or Star and Wheel

Nodes communicate with one central node. The central node need not be the leader or decision maker for the network. A variation of the hub is a wheel design where the outer nodes communicate with one or two other outer nodes in addition to the hub. A wheel configuration is a common feature of a financial or economic network.

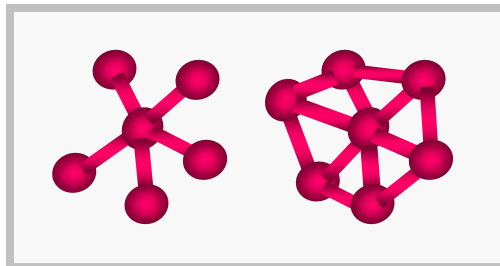

Figure 3-4. Hub - Wheel Network

- All-Channel

All nodes are connected to each other. The network is organizationally “flat,” meaning there is no hierarchical command structure above it. Command and control is distributed within the network. This is communication intensive and can be a security problem if the linkages can be identified or reconstructed. However, the lack of an identifiable “head” confounds targeting and disruption efforts normally effective against hierarchies.

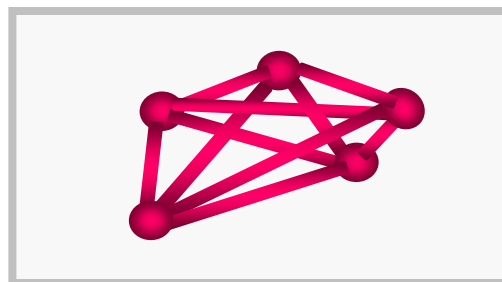

Figure 3-5. All Channel Network

Despite their differences, the three basic types will most likely be encountered together in hybrid organizations, where the particular organizational capability of a hybrid network type is most appropriate. Thus, a transnational terrorist organization might use chain networks for its money-laundering activities, tied to a wheel network handling financial matters, tied in turn to an all-channel leadership network to direct the use of the funds into the operational activities of a hub network conducting pre-targeting surveillance and reconnaissance. Organizational structure that may appear very complex during initial assessments of terrorist groups may be more understandable when viewed in the context of chain, hub variants, or all-channel networks.

Section II: Categories of Terrorist Organizations

There are many different categories of terrorism and terrorist groups that are currently in use. These categories serve to differentiate terrorist organizations according to specific criteria, which are usually related to the field or specialty of whoever is selecting the categories. Also, some categories are simply labels appended arbitrarily, often by the media. For example, every terrorist organization is by definition “radical,” as terror tactics are not the norm for the mainstream of any group. While this guide does not employ these categories in describing the operational aspect of terrorist groups, some categories do provide pertinent descriptive

information. Doctrinal terrorism can be described as based on a universalistic political ideology or religious dogma. This is in contrast to nationalist-ethnic terrorism that centers on national or ethnic identity.¹³¹ This section addresses many of the more common classifications, and provides explanation of terms and their relationship.

Government Affiliation Categories

Categorizing terrorist groups by their affiliation with governments provides indications of their means for intelligence, operations, and access to types of weapons. U.S. joint doctrine identifies three affiliations: non-state supported, state-supported, and state-directed terrorist groups.¹³²

- Non-state supported. These are terrorist groups that operate autonomously, receiving no significant support from any government.
- State-supported. These are groups that generally operate independently but receive support from one or more governments.
- State-directed. These groups operate as an agent of a government and receive substantial intelligence, logistic, and operational support from the sponsoring government.

Motivation Categories

Motivation categories describe terrorist groups in terms of their ultimate goals or objectives. While political or religious ideologies will determine the “how” of the conflict, and the sort of society that will arise from a successful conclusion, motivation is the “what”; what the end state or measure of success is. Some of the common motivation categories are:

- Separatist. Separatist groups are those with the goal of separation from existing entities through independence, political autonomy, or religious freedom or domination. The ideologies separatists subscribe to include social justice or equity, anti-imperialism, as well as the resistance to conquest or occupation by a foreign power.
- Ethnocentric. Groups of this persuasion see race as the defining characteristic of a society, and therefore a basis of cohesion. There is usually the attitude that a particular group is superior because of its inherent racial characteristics.
- Nationalistic. The loyalty and devotion to a nation, and the national consciousness derived from placing one nation’s culture and interests above those of other nations or groups is the motivating factor behind these groups. This can find expression in the creation of a new nation, or in splitting away part of an existing state to join with another that shares the perceived “national” identity.

¹³¹ Long, *The Anatomy of Terrorism*, 65.

¹³² Joint Pub 3-07.2. *Joint Tactics, Techniques, and Procedures for Antiterrorism*, 17 March 1998, II-6.
[Revision First Draft dated 9 April 2004 exists at time of publication]

- **Revolutionary:** These groups are dedicated to the overthrow of an established order and replacing it with a new political or social structure. Although often associated with communist political ideologies, this is not always the case, and other political movements can advocate revolutionary methods to achieve their goals.

Ideological Categories

“From fanaticism to barbarism is only one step.”

Denis Diderot

Ideological categories describe the political, religious, or social orientation of the group. While some groups will be seriously committed to their avowed ideologies, for others, ideology is poorly understood, and primarily a rationale used to provide justification for their actions to outsiders or sympathizers. It is a common misperception to believe that ideological considerations will prevent terrorists from accepting assistance or coordinating activities with terrorists or states on the opposite side of the religious or political spectrum. Quite often terrorists with differing ideologies have more in common with each other than with the mainstream society they oppose.¹³³ Common ideological categories include:

Political

Political ideologies are concerned with the structure and organization of the forms of government and communities. While observers outside terrorist organizations may stress differences in political ideology, the activities of groups that are diametrically opposed on the political spectrum are similar to each other in practice.

- **Right wing:** These groups are associated with the reactionary or conservative side of the political spectrum, and often, but not exclusively, are associated with fascism or neo-Nazism. Despite this, right-wing extremists can be every bit as revolutionary in intent as other groups, the difference being that their intent is to replace existing forms of government with a particular brand of authoritarian rule.
- **Left wing:** These groups are usually associated with revolutionary socialism or variants of communism (e.g., Maoist, Marxist-Leninist). With the demise of many communist regimes, and the gradual liberalization of the remainder towards capitalism, left-wing rhetoric can often move towards and merge with anarchistic thought.
- **Anarchist:** Anarchist groups are anti-authority or anti-government, and strongly support individual liberty and voluntary association of cooperative groups. Often blending anti-capitalism and populist or communist-like messages, modern anarchists tend to neglect the problem of what will replace the current form of government, but generally promote that small communities are the highest form of political organization necessary or desirable. Currently, anarchism is the ideology of choice for many individuals and

¹³³ Christopher C. Harmon, *Terrorism Today* (London: Frank Cass Publishers, 2000; reprint, Portland: Frank Cass Publishers, 2001), 198.

small groups who have no particular dedication to any ideology, and are looking for a convenient philosophy to justify their actions.

Religious

Religiously inspired terrorism is on the rise, with a forty-three percent increase of total international terror groups espousing religious motivation between 1980 and 1995.¹³⁴ While Islamic terrorists and organizations have been the most active, and the greatest recent threat to the United States, all of the major world religions have extremists that have taken up violence to further their perceived religious goals. Religiously motivated terrorists see their objectives as holy writ, and therefore infallible and non-negotiable.

Religious motivations can also be tied to ethnic and nationalist identities, such as Kashmiri separatists combining their desire to break away from India with the religious conflict between Islam and Hinduism. The conflict in Northern Ireland also provides an example of the mingling of religious identity with nationalist motivations. There are frequently instances where groups with the same general goal, such as Kashmiri independence, will engage in conflict over the nature of that goal (religious or secular government).

Christian, Jewish, Sikh, Hindu and a host of lesser known denominations have either seen activists commit terrorism in their name, or spawned cults professing adherence to the larger religion while following unique interpretations of that particular religion's dogma. Cults that adopt terrorism are often apocalyptic in their worldview, and are highly dangerous and unpredictable. It is interesting to note that religiously motivated terrorists are among the most energetic developers of Weapons of Mass Destruction (WMD) for terrorist use. Also, religiously inspired cults executed the first confirmed uses of biological and chemical nerve agents by terrorists.

Social

Often particular social policies or issues will be so contentious that they will incite extremist behavior and terrorism. Frequently this is referred to as "single issue" or "special interest" terrorism. Some issues that have produced terrorist activities in the United States and other countries are:

- Animal rights
- Abortion
- Ecology/environment
- Minority rights

“The overall threat posed by special interest extremism appears to be increasing.”

From “Terrorism in the United States, 1999” FBI Publication #0308, Federal Bureau of Investigation

¹³⁴ Bruce Hoffman, *Inside Terrorism* (New York: Columbia University Press, 1998), 90.

Location or Geographic Categories

Geographic designations have been used in the past, and although they are often confusing, and even irrelevant when referring to international and transnational terrorism, they still appear. Often, a geographical association to the area with which the group is primarily concerned will be made. “Mid-Eastern” is an example of this category, and came into use as a popular shorthand label for Palestinian and Arab groups in the 1970s and early 1980s. Frequently, these designations are only relevant to the government or state that uses them. However, when tied to particular regions or states, the concepts of domestic and international terrorism can be useful.

- *Domestic* or *Indigenous*. These terrorists are “home-grown” and operate within and against their home country. They are frequently tied to extreme social or political factions within a particular society, and focus their efforts specifically on their nation’s socio-political arena.
- *International* or *Transnational*. Often describing the support and operational reach of a group, these terms are often loosely defined, and can be applied to widely different capabilities.
 - International groups typically operate in multiple countries, but retain a geographic focus for their activities. Hizballah, for example, has cells worldwide, and has conducted operations in multiple countries, but is primarily concerned with events in Lebanon and Israel.
 - Transnational groups operate internationally, but are not tied to a particular country, or even region. Al Qaeda is transnational; being made up of many nationalities, having been based out of multiple countries simultaneously, and conducting operations throughout the world. Their objectives affect dozens of countries with differing political systems, religions, ethnic compositions, and national interests.

An insurgency-linked terrorist group that routinely crosses an international border to conduct attacks, and then flees to safe haven in a neighboring country, is “international” in the strict sense of the word, but does not compare to groups that habitually operate across regions and continents.

Section III: Knowledge Exchange and Proliferation Between Organizations

Terrorist groups increase their capabilities through the exchange of knowledge. These exchanges occur both directly and indirectly. Direct exchange occurs when one group provides the other with training or experienced personnel not readily available otherwise. An example of direct exchange is the provision of sophisticated bomb construction expertise by the IRA and ETA to less experienced groups. In 2001, three members associated with the IRA were arrested in Colombia. Traveling on false passports and with traces of explosives on their clothes and luggage,¹³⁵ the three individuals appeared to be an instance of inter-group terrorist support in use of explosives and other terrorist

¹³⁵ Rachael Ehrenfeld, *IRA + PLO + Terror* [journal on-line] American Center for Democracy (ACD), 21 August 2002; available from <http://public-integrity.org/publications21.htm>; Internet; accessed 13 February 2004.

techniques. U.S. government reports state an IRA and FARC connection since at least 1998 with multiple visits of IRA operatives to Colombia. Terrorism techniques not previously observed as a norm in FARC operations, such as use of secondary explosive devices, indicate a transfer of IRA techniques.¹³⁶

In order to disseminate much of this knowledge, terrorist organizations often develop extensive training initiatives. Al Qaeda, for instance, has assembled in excess of 10,000 pages of written training material, more than 100 hours of training videos, and a global network of training camps.¹³⁷ This training material can be distributed in both hard copy or via the Internet.

Indirect transfer of knowledge occurs when one group carries out a successful operation and is studied and emulated by others. The explosion of hijacking operations in the 1970s, and the similar proliferation of hostage taking in the 1980s were the result of terrorist groups observing and emulating successful techniques. However, this type of knowledge transfer is not restricted to just violent international terrorist groups. The same is true for many of the single-issue groups located in the United States. The Stop Huntingdon Animal Cruelty (SHAC) group uses tactics initially used by British activists, which targets the homes of individuals that are related in some form to Huntingdon Life Sciences, an animal-testing lab. They use tactics just short of physical violence in terrorizing families and entire neighborhoods, such as showing up with sirens and bullhorns at 3 a.m., plastering the neighborhood with photographs of mutilated dogs, and posting home and work phone numbers on the Internet. An Oregon-based watchdog group, Stop Eco-Violence, stated that they are seeing a copycat effect within the eco-terror movement, with other groups now using the same tactics.¹³⁸

These examples of knowledge exchange highlight the fact that assessments of terrorist threat capabilities cannot only be based upon proven operational abilities. Military professionals must evaluate potential terrorist threats according to what capabilities they may acquire through known or suspected associations with other groups. Also, consideration must be given to capabilities that can reasonably be acquired through the study and employment of techniques and approaches that have proven successful for other terrorist organizations.

A development related to this is the proliferation of specialized knowledge useful to terrorists over the last decade. The reductions in military and intelligence establishments after the Cold War have made expertise in sabotage, espionage, small unit tactics, and other useful skills readily available. Similar reductions in research and development institutions make technical and scientific expertise in weapons of mass destruction, information technology, and electronic countermeasures more accessible, either through direct contacts or intermediaries such as rogue or dysfunctional states.

¹³⁶ Jan Schuurman, *Tourists or Terrorists?* [press review on-line] Radio Netherlands, 25 April 2002; available from <http://www.rnw.nl/hotspots/html/irel020425.html>; Internet; accessed 13 February 2004.

¹³⁷ Ben Venzke and Aimee Ibrahim, *The al-Qaeda Threat: An Analytical Guide to al-Qaeda's Tactics and Targets* (Alexandria: Tempest Publishing, LLC, 2003), 7.

¹³⁸ Don Thompson, "British Ecoterror Tactics Spread to U.S. Activists," *The Mercury News*, 10 May 2003, 1-2; available from <http://www.mercurynews.com/mld/mercurynews/news/local/5832723.htm?1c>; Internet; accessed 21 April 2004.

Conclusion

This chapter provided descriptions of the common organizational models for terrorist groups. It also presented an array of categories and descriptions of terrorists and terrorist groups, in order to clarify the jargon that surrounds this topic, and to avoid those terms that are not useful for the purposes of military professionals assessing the terrorist threat.

Page Intentionally Blank

Chapter 4

Assessing Terrorist Capabilities and Intentions

Everything was absolutely ideal on the day I bombed the Pentagon. The sky was blue. The birds were singing. And the bastards were finally going to get what was coming to them.

Bill Ayers, Former Weather Underground leader in his memoir *Fugitive Days*

This chapter examines the nature of the terrorist threat to U.S. military forces. Principal themes focus on the following aspects:

- Understand who will want to engage U.S. military forces utilizing terror tactics, and why attacking military targets would be desirable.
- Explore why particular U.S. forces would be targeted, and how that targeting is accomplished against U.S. forces.
- Provide context by categorizing U.S. forces based upon their status as Deployed Forces, In-transit Forces (deploying or redeploying), and Institutional (Non-deployable) Forces.
- Clarify the categorization of various threats by categorizing terrorist groups by their functional capabilities. Each threat should be examined in the context of its particular operational environment. The nature of terrorist individual or group associations and affiliations, the current or projected levels of training, the decisionmaking authority within an organization to plan and act, and the sophistication of other emergent tactics, techniques, and procedures are examples of several critical variables

When discussing terrorist attacks on “military targets,” targets include individuals or facilities that are attacked because of their military identity. These type attacks include off duty personnel in civilian settings specifically attacked because of their status as military personnel. Normally, this does not address military personnel or activities that are victims of attacks directed at non-military targets.

Clarifying terminology assists in understanding terrorist aims in the context of goals and objectives.

Objective: The standard definition of *objective* is – “The clearly defined, decisive, and attainable aims which every military operation should be directed towards.”¹³⁹ Terrorist objectives refer to the intended outcome or result of one or a series of terrorist operations or

¹³⁹ Joint Publication 1-02, *Department of Defense Dictionary of Military and Associated Terms*, 12 April 2001, as amended through 9 June 2004.

actions at the tactical or operational levels of war as described in Joint Pub 1-02: activities of battles and engagements to accomplish objectives, may imply a broader dimension of time or space than tactics; and provide means to exploit success to achieve strategic objectives.

Goals: The term *goals* will refer to the strategic end or end state that the terrorist objectives are intended to obtain. Organization goals equate to a strategic level as in Joint Pub 1-02.

The United States entered the twenty-first century as the single most influential nation in the world. The world perceives the United States as the sole remaining superpower, the victor of the Cold War. Some quarters view the United States as a hegemonic enforcer of its own brand of order and stability.¹⁴⁰ Because of this influence, anyone seeking to change the existing world order through aggression, coercion or violence sees the United States as an eventual adversary. As a result, they seek means to challenge the United States. Various forms of low intensity conflict, and competition and conflicts short of war are seen by most of America's potential adversaries as the most promising methods of presenting this challenge.¹⁴¹ Terrorism is a component of these strategies.

U.S. diplomatic, military, and economic interventions have become more frequent, and more significant in the last several decades. Because of this U.S. presence and influence abroad, some antagonists see terrorism as the only effective means of competing with the United States. In terms of effectiveness, al Qaeda alone has killed more Americans with terrorist attacks than all of the casualties suffered in all the campaigns and interventions since 1980, including both Gulf Wars. The resulting effects on the United States have been immense, and the unprecedented response by the U.S. to the threat of terrorism encourages the belief that the asymmetric approach of terrorism is the only way of defeating the United States.

As part of the overall primacy of American power, United States military forces have demonstrated dominant conventional capabilities through successful campaigns and participation in multiple international interventions. Despite this level of preeminence, U.S. military forces remain vulnerable to terrorist operations.

There are concrete reasons to consider terrorism as a specific and pervasive risk for U.S. forces. Factors contributing to a greater danger of attack to military forces are:

Some groups have actually identified the U.S. military as targets. Al Qaeda has specifically identified military targets as one of its two major priorities,¹⁴² and the FARC has stated that any U.S. forces deployed in Colombia are considered targets.

The improved protection or "hardening" of many non-military targets. Formerly, non-military targets were "softer" due to a lower degree of security consciousness and a lack of belief in a credible threat. Frequent attacks on non-military personnel and organizations, both government and corporate, have resulted in the imposition of improved security measures, greater threat awareness, and acceptance of increased expenditures for protection on many of

¹⁴⁰ Qiao Liang and Wang Xiangsui, *Unrestricted Warfare*, trans. Department of State, American Embassy Beijing Staff Translators (Washington, D.C., 1999).

¹⁴¹ *Ibid.*, Part III.

¹⁴² Ben Venzke and Aimee Ibrahim, *The al-Qaeda Threat: An Analytical Guide to al-Qaeda's Tactics and Targets* (Alexandria: Tempest Publishing, LLC, 2003), 76.

these targets. This increase in the level of difficulty to the terrorist has reduced the bias toward non-military targets.

The increasing exposure of forward deployed and internationally based military forces can encourage terrorist activities. As of February 2004, the United States had military forces located in over 120 countries performing duties from combat operations, to peacekeeping, to training foreign militaries.¹⁴³ Clearly, increases in the operations tempo and the number of overseas deployments raise the odds that U.S. forces will operate in areas that are more accessible to terrorist groups than CONUS or established overseas bases. This is especially true when the potential military target may in fact come directly to the terrorist, operating in his stronghold due to mission requirements. Likewise, some countries where U.S. forces are permanently based have groups of domestic terrorists that would not be a threat outside that country, yet pose significant risk to units or individuals stationed there.

The symbolic value of successful attacks against military targets has often been a consideration in terrorist planning. This is now particularly true of the U.S. military, widely perceived as the premiere military in the world. The primacy of the U.S. Department of Defense in the response to the September 11th attacks, and the operations in Afghanistan and Iraq further raises the profile of the U.S. military. Improved public perceptions about the military from the U.S. viewpoint increase their value as terror targets. To many regions, however, the U.S. member in the Armed Forces is a symbol of imperialism. Consequently, striking at a respected institution whose members have public sympathy at home, and who is perceived as a threat in many regions of the world, and who constitutes a direct threat to terrorist groups will become highly attractive. The potential status and psychological impact of such a coup is a strong inducement to all types of terrorist groups. Additionally, terrorist groups recognize that even relatively small losses of military forces from terrorist attacks receive extensive media coverage and can destroy popular and political support for military operations by Western governments.¹⁴⁴

The aims and methods of terrorists – particularly religious extremists – have grown more radical, innovative and difficult to predict. A generational change in leadership can have varied outcomes. In some cases, more destruction may result; in other cases, organizations may simply lose their cohesion and cease to be a significant influence. Added to this is the effect of extended periods of turmoil and conflict in many regions of the world for the past two decades. This provides recruits and followers that have been desensitized to violence, and who have known nothing but conflict and insecurity for all of their lives. Reading the works of people such as Mawdudi, Qutb, and Faraj, and the further interpretations of various universities and Muslim clerics, concepts of violence and religion as a supposed support should not appear surprising.¹⁴⁵ As noted in *Jihad: The Trail of Political Islam*, “The dispersion all over the world, after 1992, of the jihadist-salafists formerly concentrated in

¹⁴³ “Where are the Legions? [SPQR] Global Deployments of US Forces,” Global Security.org, 16 April 2004, 1; available from <http://www.globalsecurity.org/military/ops/global-deployments.htm>; Internet; accessed 21 April 2004.

¹⁴⁴ Ben Venzke and Aimee Ibrahim, *The al-Qaeda Threat: An Analytical Guide to al-Qaeda's Tactics and Targets* (Alexandria: Tempest Publishing, LLC, 2003), 77.

¹⁴⁵ Mark Juergensmeyer, *Terror in the Mind of God* (Berkeley and Los Angeles: University of California Press, 2000), 81-82.

Kabul [Afghanistan] and Peshawar [Pakistan], more than anything else, explains the sudden, lightning expansion of radical Islamism in Muslim countries and the West.”¹⁴⁶

Section I: Potential Adversaries and Their Motivations

Potential Adversaries

There are a large number of terrorist organizations active in the world today, and a wide variety of them are potential antagonists willing to attack U.S. military forces throughout the world. Some of these groups, such as al Qaeda are transnational in nature, whereas others such as the Revolutionary Armed Forces of Colombia (FARC) are more regionally focused. However, in both cases, they have identified the U.S. military as potential targets. Appendix A contains a listing of specific terrorist groups and their operational range. The threat environment for terrorism is too dynamic to discuss specific groups or individuals in this context, but identifying situations that may exacerbate or trigger the motivations of potential adversaries can assist in developing some idea of whose interests are served by such attacks.

- **Presence** – Many antagonists are opposed to the presence of U.S. military forces in a particular area, or the presence of organizations U.S. forces are safeguarding. Frequently, this opposition is because the U.S. presence is preventing particular political, military, or criminal activities, but it can also be culturally inspired. Another possibility is that the presence of U.S. forces is viewed as an opportunity to eliminate or dominate rival factions, and attacks on U.S. forces would be staged in the hopes that the U.S. would encourage the suppression or disarmament of rivals. Usama bin Laden is an excellent example of someone opposed to U.S. presence in an area, i.e., the Arabian Peninsula. In particular, he sees the United States as invaders of the land of Islam by “occupying the territory of the Two Holy Places” (U.S. military bases in Saudi Arabia).
- **Culture** – Antagonists who are directly opposed to one or more major characteristics of American culture, such as capitalism, secular democracy, polytheism, pop culture, women’s rights, sexual freedom, or racial tolerance; will attack Americans wherever found. Groups primarily motivated by cultural differences will not differentiate between civilian and military targets, other than in their respective degree of risk and difficulty to attack.
- **State of Conflict** – Groups that feel that they are “at war,” or in a social or political conflict with the United States will target military personnel and facilities to gain legitimacy and make statements. Likewise, states that are engaged in or anticipate hostilities with the U.S. will use sponsored terrorist organizations or clandestine military or intelligence assets to attack military targets.¹⁴⁷

¹⁴⁶ Gilles Kepel, *Jihad: The Trail of Political Islam* (Cambridge: The Belknap Press of Harvard University Press): 299.

¹⁴⁷ Christopher C. Harmon, *Terrorism Today* (London: Frank Cass Publishers, 2000; reprint, Portland: Frank Cass Publishers, 2001), 52.

In considering who may be our potential antagonists, several things must be kept in mind. While a “threat” is normally considered to be an actor with both the capability *and* intention to actively oppose the U.S.,¹⁴⁸ both these factors can shift rapidly when dealing with terrorist organizations.

Evaluate all known and suspected terrorist groups in a regional area of operations regardless of their previous attitude toward the U.S. and U.S. military. Terrorism is dynamic, and behavior patterns volatile. Groups that are neutral or that avoided targeting U.S. interests in the past can change their attitudes rapidly. Announced or perceived U.S. policy may antagonize previously neutral groups, if that policy conflicts with the goals or objectives of the group. Changes in leadership or internal fractionalization of a group may cause changes in targeting policies or priorities. Also, any organization amoral enough to utilize terrorism as a tactic will not hesitate in exploiting an “ally” or partner if the benefits seem to warrant it. For all these reasons, assumptions regarding previous attitudes of terrorists toward targeting U.S. military assets should be reexamined frequently and with a highly critical mindset.

In assessing potential antagonists, avoid considering only those threats that are viewed as particularly large or well known. There is a popular tendency to allow the amount of media attention a group can command to determine how we perceive its effectiveness or lethality. Because of the nature of the modern news media, as well as the acknowledged skill of terrorist groups in manipulating it, this is an invalid approach. Small, little known groups, especially the “want-to-be” groups, can pose threats that are as probable as larger groups, and every bit as dangerous. This is particularly true when operating in a region or country not previously accustomed to a U.S. military presence, and where domestic or indigenous groups may suddenly be presented with the opportunity of gaining international attention through an attack on U.S. forces.

Motivations to Attack U.S. Forces

During the post-colonial and nationalist insurgencies of the Cold War, terrorists might consider one civilian casualty was more effective than several military casualties. This was due to the fact that many insurgencies had simultaneous military and terror campaigns, so the novelty and impact of military casualties was lessened.¹⁴⁹ Even when not involved in hostilities, military casualties delivered less psychological impact because of expectations that military personnel are “at-risk” due to their profession. Terrorists also pursue soft targets, preferring unarmed, less secure victims. A saying attributed to any number of terrorists is “Why hunt wolves when there are so many sheep about?” While there are exceptions to this, such as the consistent targeting of British soldiers and police by the IRA, targeting civilians was the clearly preferred tactic.

“One corpse in a [suit] jacket is always worth more than twenty in uniform. “

Ramdane Abane, Senior FLN Terrorist Leader

¹⁴⁸ FM 7-100, *Opposing Force Doctrinal Framework and Strategy*, May 2003.

¹⁴⁹ Bruce Hoffman, *Inside Terrorism* (New York: Columbia University Press, 1998), 61.

As terrorism became less and less associated with classical insurgencies and more international in scope, the preference for civilian targets became less pronounced. American military installations and personnel were frequently targeted in the 1980s and 1990s by anti-NATO European terrorists, and by state sponsored terrorists acting on behalf of a variety of regimes.¹⁵⁰ These attacks generally struck at military targets that were not engaged in hostilities, but that were accessible to the terrorists due to their being based or deployed overseas. This trend has accelerated, although the focus has shifted from Europe to the Persian Gulf region.

There are two strategic factors in terrorists accepting the greater risks associated with attacking military targets: accessibility and symbolic value.

- **Accessibility** – Military forces are often based or deployed into areas that are “permissive” to terrorist operations. These environments need not be destabilized regions or failed and dysfunctional states such as Bosnia, Lebanon or Somalia, but can also be functioning states with liberal laws, permissive border controls, and existing terrorist infrastructures.
- **Symbolic Value** – For the United States, commitment of military forces is a significant indicator of national interest, and carries major political consequences. Targeting military forces so committed can achieve a greater visibility and significance than targeting existing civilian targets such as diplomats or commercial personnel and facilities. Additionally, the presence of U.S. forces in some regions, allegedly offending political or religious sensibilities, can be presented as a justification for a demonstration or attack.

Section II: Considerations in Targeting U.S. Forces

A principal consideration in terrorist targeting is the psychological impact on the selected audience. U.S. forces whose destruction or damage would provide a psychological impact that serves the goals of the terrorist are therefore at risk. However, a key point must be understood. Assessment of risk to potential targets must focus less on their military value, and more on their value to the terrorist in terms of psychological impact.

Risk Assessment

U.S. military risk assessment normally looks at what is most militarily valuable (mission essential) to us. Operationally vital systems and equipment, or key personnel are assumed to be at greater risk based upon an estimation of their military worth in particular conditions. However, the benefits for a terrorist organization do not lie in defeating our military aims. A terrorist may view value as a function of the overall psychological impact that destruction of a target will have on a population, as well as the cascading physical effects of damaging or destroying a critical piece or aspect of an organization or infrastructure. The loss of a single piece of equipment (such as an artillery targeting radar) has important military impact, but little psychological impact outside the unit or organization that relies on it. For a terrorist,

¹⁵⁰ *International Encyclopedia of Terrorism*, 1997 ed., s.v. “Chronology of Terrorist Events.”

expending assets to destroy such a piece of equipment would not make sense unless it were tied to some other event or objective.

From a terrorist's perspective, targeting individual soldiers, especially those that are not perceived to be in imminent danger or engaged in hostilities, is very effective. Several soldiers kidnapped and gruesomely murdered would have a small overall military impact, but a potentially huge psychological payoff for the terrorist. With the atrocity recorded as digital video and streamed via multiple sources on the Internet to bypass any self-censorship news networks might exercise, it would be accessible throughout the world. Palestinian groups have conducted this tactic with varying degrees of success against Israeli soldiers and various terrorist groups have used it against American civilians.

Consider the amount of media attention given the abduction and eventual murder of reporter Daniel Pearl in 2002, and how the video of his murder was nearly presented on cable television networks. Use of this tactic continued in 2004 when two Americans were kidnapped and beheaded by terrorists. Nicholas Berg was an American businessman seeking telecommunications work in Iraq when he was kidnapped and beheaded in May 2004. Another American, Paul Johnson who worked for Lockheed Martin in Saudi Arabia, was kidnapped and beheaded in June 2004. In both cases, the terrorists disseminated videos (Berg) and pictures (Johnson) of the beheadings over the Internet.

Undoubtedly, the technique used in the three murders discussed above would be effective even if soldiers were the victims. As a society, Americans value life and are often believed to be adverse to any casualties. Terrorists understand this American trait, and as stated in Chapter 2, view our aversion to casualties as a vulnerability. A case in point occurred during the air campaign against Serbia in the spring of 1999. Three U.S. Army soldiers patrolling the Yugoslav-Macedonian border during this period became separated from a larger patrol and were captured by the Serbians. Serbian President Slobodan Milosevic orchestrated an international media campaign during the capture and month long captivity of the three. Maintaining an ambiguous stance on the status of the prisoners, and their possible fate, Milosevic eventually scored a coup by releasing the three to an unofficial mission of prominent American political figures, resulting in even more media coverage. In this case, the political and psychological impact far outweighed any operational impact caused by the capture of three soldiers and one vehicle. While Milosevic enjoyed some advantages as a head of state that few terrorist organizations will possess, proper media manipulation can make up this deficiency.

The media and sensational incidents can acquire a life of their own as reports and speculations sometimes create an event far beyond the actual incident. Although not terrorist related, the 2003 publicity surrounding the wartime capture, rescue, and subsequent medical rehabilitation of U.S. soldier Jessica Lynch quickly erupted as a major storyline and continued to stage headlines for months after the combat action. Months later, she was still receiving national and international news coverage on particular aspects of the capture.¹⁵¹

¹⁵¹ "Too Painful" *ABC News* [news on-line] 11 November, 2003; available from http://abcnews.go.com/sections/Primetime/US/Jessica_Lynch_031106-1.html; Internet; accessed 12 February 2004.

Reasons for Targeting

With the variety of terrorist motivations and goals, the reasons to target U.S. military units or individual personnel are equally varied. The most common motivations in recent history are discussed below.

Demonstration of Capability

This is a method to demonstrate a group's ability to deliver on its threats, and to establish a level of effectiveness as a future threat. Targets may be selected for either military or symbolic value, but the true intent is to show that the terrorist has the capability to negate a U.S. military advantage and concurrently promote their organizational agenda. Senior military officials are often a target. The Red Army Faction (RAF) conducted numerous terrorist activities against military presence in Germany and countries of the North Atlantic Treaty Organization (NATO) in the 1970s and 1980s. Shifting from goals for a complete revolution of German society, the RAF concentrated much of their capabilities on a campaign to reduce NATO and U.S. military presence in Germany as a way to possibly build a more sympathetic understanding for societal change in Germany.¹⁵²

In 1979, the RAF attempted to assassinate General Alexander Haig, the Supreme Allied Commander in Europe and NATO. A remotely controlled bomb had been placed in a road culvert near Casteau, Belgium that was used frequently by General Haig. A detonator of nine-volt batteries and a household switch connected the bomb via 500 feet of wire that was camouflaged by earth and grass. The blast lifted the general's car into the air and damaged the accompanying security vehicle; three guards in the security vehicle were lightly injured.¹⁵³

In 1981, General Frederick Kroesen and his wife were slightly injured when their car was attacked by terrorists, believed to be associated with the RAF, with rocket propelled grenades and gunfire. The assassination attempt occurred near Heidelberg, Germany, as the general was enroute to his headquarters as the Commander in Chief of United States Army Europe and Commander of NATO's Central Army Group. One site about 200 yards from the target point evidenced terrorist surveillance activity with an abandoned tent, radio transmitter, sleeping bag, and food.¹⁵⁴ Fortunately the terrorists failed in their attempts to assassinate General Kroesen and General Haig; however, these attacks are examples of terrorist groups demonstrating their capabilities to deliver on their threats.

A more recent and more successful example is the Khobar Towers attack in Saudi Arabia. To Islamic fundamentalists, the presence of U.S. military forces in Saudi Arabia is considered particularly offensive due to the religious importance of the Saudi city of Mecca. In June of 1996, a housing facility for U.S. Air Force personnel near Dhahran, Saudi Arabia was attacked with a large truck bomb. The Khobar Towers attack killed nineteen U.S. Air Force

¹⁵² Walter Reich, ed., *Origins of Terrorism: Psychologies, Ideologies, Theologies, States of Mind*, rev. ed. (Washington: Woodrow Wilson Center Press, 1998), 49-51.

¹⁵³ John Vinocur, "Bomb Attempt on Gen. Haig's Life Not Tied to Major Terrorist Groups," *New York Times*, 27 June 1979, p. A13.

¹⁵⁴ John Vinocur, "U.S. General Safe in Raid in Germany," *New York Times*, 16 September 1981, p. A1.

personnel and wounded about 400 other U.S. military members,¹⁵⁵ and demonstrated terrorist ability to back up threats with effective action. Members of Saudi Hizballah, a member of Lebanese Hizballah, and an unnamed Iranian were indicted by the U.S. Department of Justice for this act of terrorism. On the heels of this attack, terrorists declared war on American forces in the Persian Gulf region in August 1996, and announced that all U.S. forces must be withdrawn, or suffer further attacks.

Influence U.S. Policy

Terrorists can attack military forces with the intent to force a change in U.S. policy. Hizballah and their Syrian sponsors were concerned that the deployment of international peacekeeping forces into Lebanon in the spring of 1983 would reduce their freedom of action in the ongoing Lebanese Civil War. Near-simultaneous suicide truck bomb attacks on the U.S. Marine and French paratroop barracks in October of 1983 killed 241 U.S. servicemen, and 60 French paratroopers. Combined with an earlier bombing campaign against the embassies of the U.S. and other countries, these attacks resulted in the withdrawal of the international military force.

Domestic Politics

The desire to discredit U.S. Federal, state, and local governments can result in military units and personnel being targeted by domestic groups. Anti-war extremist groups targeted ROTC detachments, draft board offices, and university facilities involved in military research during the Vietnam War.¹⁵⁶

The Weather Underground likewise targeted recruiting offices in the late 70's. Both of these campaigns were undertaken to influence U.S. domestic politics. In more recent times, various anti-government groups have targeted CONUS military bases believing them to be staging areas for United Nations directed foreign military forces. During the twenty-year period from 1980 to 1999 (inclusive), thirteen specifically domestic military targets were struck by terrorist activity. This does not count military facilities or personnel who were collocated in the other 101 U.S. Government targets that were attacked.¹⁵⁷



Figure 4-1. **U.S. Marine Barracks, Beirut**
(Source: USMC Photo)

¹⁵⁵ Christopher C. Harmon, *Terrorism Today* (London: Frank Cass Publishers, 2000; reprint, Portland: Frank Cass Publishers, 2001), 71.

¹⁵⁶ *International Encyclopedia of Terrorism*, 1997 ed., s.v. "Student Terror: The Weathermen"

¹⁵⁷ Department of Justice, Federal Bureau of Investigation, Counterterrorism Threat Assessment and Warning Unit, Counterterrorism Division, *Terrorism in the United States 1999*, Report 0308, (Washington, D.C., n.d.), 53.

¹⁵⁸ Colonel James "Nick" Rowe (Psychological Operations Web Site, n.d.); available at <http://www.psywarrior.com/rowe.html>; Internet; accessed 7 January 2003.

Reduce Military Capability

Military forces can be targeted to reduce or remove a specific capability or impair effectiveness. Killing one key or very effective individual can also reduce the motivation for others to accept responsible positions or perform above the norm, and thereby risk becoming targets. This tactic will usually be combined with some symbolic justification, such as “justice” applied by the terrorists because of alleged “war crimes” perpetrated by the victim.

The assassination of Colonel Nick Rowe in Manila provides a good example of this. Colonel Rowe was in charge of the Joint U.S. Military Assistance Group for the Philippines. His two years there had been spent contributing to the improvement of the Philippine Army’s counterinsurgency capability, and the insurgent New People’s Army (NPA) felt he was doing his job too well. He was assassinated in April of 1989 in a moving ambush where small arms fire defeated the protection of his armored official vehicle. The NPA announced that the reason for the assassination was Colonel Rowe’s notable Vietnam service record. The NPA hoped this would draw the parallel that the Philippines were becoming “another Vietnam.” This justification was not stressed at the time, and seems to have been of much less importance to the NPA than the elimination of the threat posed by Colonel Rowe’s activities.¹⁵⁸

Prevent or Delay Deployment

During Operation Desert Shield, Saddam Hussein called for terrorist activity to be directed against the countries of the coalition preparing to invade Iraq. Attacks conducted by indigenous terrorist groups Dev Sol and 17 November took place against U.S. staging areas in Turkey and Greece. Iraq directly supported these overseas attacks with weapons components delivered via diplomatic pouch and other assistance.¹⁵⁹ Although Saddam Hussein did not have the influence to convince or compel a larger Mideast surge in terrorism, terrorist activities in general did increase during the period of the air campaign and subsequent invasion of Iraq, totaling 275 incidents.¹⁶⁰ Due to extensive counter-terrorism efforts and international coordination, the overall effort to disrupt coalition deployments was ineffective. However, this period is a vivid example of the threat that both deployed and deploying units may face in the future.

In addition to terrorist activities outside Iraq, the Iraqi government conducted what amounted to the largest hostage taking in modern time. They seized 10,000 Kuwaiti citizens, and hundreds of foreigners resident in Iraq, as “human shields” immediately after the start of Operation Desert Shield and during preparations for the liberation of Kuwait. Fortunately, most of the hostages were released before the initiation of Desert Storm.¹⁶¹

Other terrorist incidents indicate the potential for disrupting deployments or materiel in transit. The tensions of political, environmental, and economic impacts add to the specific damage or destruction of an incident. The terrorist suicide boat bombing in 2002 of the

¹⁵⁹ Christopher C. Harmon, *Terrorism Today* (London: Frank Cass Publishers, 2000; reprint, Portland: Frank Cass Publishers, 2001), 52.

¹⁶⁰ *Ibid.*, 52.

¹⁶¹ *International Encyclopedia of Terrorism*, 1997 ed., s.v. “Chronology of Terrorist Events.”

French tanker ship *Limburg* near Ash Shihr and east of Aden spilled 90,000 barrels of oil into the ocean and contaminated 45 miles of coastline.¹⁶² One immediate economic impact of this small boat and TNT detonation next to the *Limburg* was a maritime insurance increase in rates that tripled in the Yemeni area.¹⁶³ Another incident involved the suicide boat bombing of the USS *Cole* in 2000 while the ship was moored at a refueling point in Aden, Yemen. Terrorists exploited access control measures and perimeter security vulnerabilities of waterside approaches to the naval ship while near the coastline. The result, besides the international media attention, was 17 sailors killed, 42 crewmembers wounded, as well as extensive damage to the ship.¹⁶⁴ In more recent military operations, during the preparation for and conduct of Operation Iraqi Freedom, threat of terrorist attacks contributed to decisions by Turkey that significantly limited U.S. use of Turkish territory, facilities, and materiel.

Section III: Categorizing Terrorist Groups by Capability

As discussed in Chapter 3, there are many different terms and labels used to describe terrorist organizations. Most of these terms provide little or no information of value to the military professional in assessing the true threat of a terrorist group as an adversary. For the unit at risk of terrorist attack, it is important to understand the capabilities the groups have that can be employed against the military unit.

In this section we will discuss a method to assist armed forces personnel in the rapid and clear assessment and comparison of terrorist threats based upon militarily relevant criteria. It is designed to help describe terror groups by their capabilities to target and attack U.S. military

“Asymmetric challenges can arise across the spectrum of conflict that will confront US forces in a theater of operations *or on US soil.*”

["Global Trends 2015: A Dialogue About the Future With Nongovernment Experts"](#) Report (December 2000).

forces, rather than by legal status, political or religious characteristics, or other value-based criteria. Capability-driven group descriptions are desirable for a variety of reasons.

Descriptions of Capabilities are Neutral. Terms describing capabilities are less likely to be emotionally charged. Attaching politically or socially relevant descriptions to a group allows

¹⁶² “Evidence Points to Yemen Terror Attack,” CBS News.com [database on-line]; available from <http://www.cbsnews.com/stories/2002/10/06/world/main524488.shtml>; Internet; accessed 21 January 2004.

¹⁶³ “The Terrorism Maritime Threat,” United Press International 2 December 2003 [Militarycom database on-line]; Internet; accessed 21 January 2004; and, “French Tanker Explosion Confirmed as Terror Attack,” [database on-line]; available from <http://www.ict.org.il/spotlight/det.cfm?id=837>; Internet; accessed 21 January 2004.

¹⁶⁴ *Statement Before the 107th [U.S.] Congress, Chairman of the Joint Chiefs of Staff*, Senate Armed Services Committee May 3, 2001; [database on-line] available from http://www.dtic.mil/jcs/chairman/3MAY01_SASC_CJCS.htm; Internet; accessed 18 February 2004.

value judgments to be made relative to those terms. Also, like legal categories and other methods of classifying terrorists, they do not contain much useful information for leaders and planners.

Descriptions of Capability do not Constrain. Accepting descriptions that focus on ideological or religious motivations for terrorist groups can be misleading, and encourage false assumptions. Ideological considerations do play a part in determining if a group will target U.S. forces, but they have no effect on that group's capability to do so. Any group can become a threat because its announced objectives or ideology can change or are misleading, perhaps even unimportant.¹⁶⁵ Also, changes to the political situation, U.S. policy, or the role or mission of U.S. forces may cause formerly neutral or ideologically allied groups to become hostile.

A relatively recent example is Afghanistan following the 1979 Soviet intervention. Initially, the United States provided massive aid to help the Afghan resistance after the Soviets invaded in December of 1979. Many of these Afghan fighters confronted the Soviets as a corrupting Western influence and the fatwas issued by the ulemas interpreted the Soviet intervention as an invasion of the territory of Islam by the impious. However, these same fighters willingly accepted Western aid in fighting the Soviet occupation. Perceptions of both the United States and the mujahedeen changed, though, following the defeat of the Soviets. After the Soviets withdrew in 1989, the Afghan cause lost some of its strategic importance and the U.S. changed its view on its support to these "freedom fighters." Washington reduced financial support, and the U.S. Congress became concerned with the drug trade and involvement by mujahedeen leaders. Consequently, these mujahedeen leaders were classified as extremists and the supply of U.S. arms stopped.¹⁶⁶ From the viewpoint of the mujahedeen, they had defeated the Soviets and seemed to forget the support they received from the United States. Many of these jihad veterans became followers of a new breed of Islamist ideology, jihadist-salafism, whose perception of the world involved religious doctrine and armed violence and whose first doctrinal principle was to rationalize the existence and behavior of militants. Although their anti-Western sentiment was set aside while the United States supported them in their jihad against the Soviets, this attitude returned after the Soviets withdrew and their primary target became the United States, who was perceived as the greatest enemy of the faith.¹⁶⁷

Measures of Capability are Militarily Significant. Most systems used to classify terrorists are militarily irrelevant. For the most part, knowing the legal status, social orientation, or political theory of a potential truck bomber is of less value than knowing what sort of explosive devices he can afford, where in the operational area he can strike, and what level of local support and sympathizers he can expect. Motivations and behaviors are important to long term terror and counter-terror strategies, but play a minor role in the tactical activities of terrorists and the true threat opposing our forces.

¹⁶⁵ Walter Reich, ed., *Origins of Terrorism: Psychologies, Ideologies, Theologies, States of Mind*, rev. ed. (Washington: Woodrow Wilson Center Press, 1998), 31-35.

¹⁶⁶ Gilles Kepel, *Jihad: The Trail of Political Islam* (Cambridge: The Belknap Press of Harvard University Press): 136-150.

¹⁶⁷ *Ibid.*, 218-220.

Specific Measures of Capability

In describing the capabilities of a terrorist group, simple, measurable, concrete terms have been selected for use. These are the objective, levels of support, training, and operational presence of a particular group. These factors drive the capabilities of a terrorist organization, not the ideology, religion, or status as determined by U.S. legislation or UN resolution. This method is not intended to add another layer of nomenclature to an already thick coat that covers terrorism analysis. It is designed to be a method by which unit leaders and planners can organize pertinent, objective data about potential threats. This data must be researched or obtained from available intelligence information on specific threats within the AOR (Area Of Responsibility) as the unit prepares to conduct operations.

Objective

By determining what the group wishes to accomplish, the likelihood and circumstances under which that group would target U.S. forces or facilities can be determined.

The objective may be derived from both communications of the organization and the actions it undertakes. Group communications must be examined with a critical eye toward the use of rhetoric and dogma. As mentioned in Chapter 2, ideological material may be unimportant to the actual objectives of a group. Actual indicators in terrorist communiqués are likely to be: what potential targets are concretely threatened and what organizations or individuals are identified with negative concepts or de-humanizing language. A group may declare itself to be “anti-colonialist”, but in fact ignore targets associated with a nation that has colonies, and associate “colonialism” with another organization such as NATO, which they intend to target.

A 2004 training publication by al Qaeda is an illustration of organizational communications transmitting the objectives of the group. In March 2004, al Qaeda released new targeting guidance to its members and other jihad groups around the world. The guidance was in a 9-page article called “The Targets Inside the Cities” and focused on urban targets. The document listed the various categories of targets, the rationale for striking them, and examples of targets within each category. It also explained the advantages of conducting operations against cities, as well as the disadvantages.¹⁶⁸

Support

There are several types of support that provide information about a terrorist group’s capabilities. These are measures of the strength of financial, political, and popular support for a group, as well as the number of personnel and sympathizers it has. These factors indicate an organization’s abilities to conduct and sustain operations, gather intelligence, seek sanctuary and exploit the results of operations.

¹⁶⁸ Ben N. Venzke, *al-Qaeda Targeting Guidance* – Version 1.0 (Alexandria, VA: IntelCenter/Tempest Publishing, LLC, 2004), 3-11.

- **Financial:** Is the organization well funded? Money is probably the greatest “force multiplier” of terrorist capabilities, and a well financed group can trade money for virtually any imaginable object or ability that their objectives require, especially weapons and equipment (discussed below). Financial support is a question of both income and expenditures. Many of the nationalist terror groups of significant durability (IRA, Hizballah) have incredibly large budgets, but they also have the infrastructure costs and political or social support obligations that come with building an alternative government or social structure.

HAMAS is an example of a terrorist organization that has strong financial backing. Although the actual amount of money available to HAMAS is difficult to determine, estimates are that they receive several tens of millions of dollars per year. Sources for their funding includes unofficial sources in Saudi Arabia and the Gulf states, including approximately \$3 million per year from Iran. They also receive funds from several charities and from some profitable economic projects.¹⁶⁹

- **Political:** Does the organization have political sponsors or representation, either within international, state, or sub-state political bodies? This measures the degree to which a group is state sponsored or supported. It also considers whether the organization has its own political representatives or party that supports its aims (if not its methods). Political support blurs the lines between terrorism and other forms of conflict, and can generate sympathy and reduce negative consequences.

Iran is probably the most active state supporter of terrorism. As reported in the State Department’s 2002 *Patterns of Global Terrorism*, Iran provided Hizballah and several Palestinian rejectionist groups, including HAMAS, the Palestine Islamic Jihad, and the Popular Front for the Liberation of Palestine-General Command, with funding, safehaven, training, and weapons.¹⁷⁰

- **Popular:** Popular support is the level of sympathy and passive or active support for the organization among populations it affects to represent, or operates within. Support from a constituency increases the effectiveness of other types of support. It makes funds go farther, and increases the legitimacy and visibility of a group. Popular support from populations the terrorists operate within reduces the security risks, and complicates the tasks of detection and defeat for the security forces.

The United Self-Defense Forces of Colombia, or AUC, is an example of a terrorist organization with strong popular support. Its leaders reported that between 2002 and 2003, AUC strength grew from 8,000 to 14,000 combatants. Once backed mostly by wealthy business and ranching interests and former military leaders, it is receiving increasing support from poor Colombians.¹⁷¹

¹⁶⁹ “Hammas,” International Policy Institute for Counter-Terrorism, Profiles of International Terrorist Organizations, n.d., 5-6; available from http://www.ict.org.il/inter_ter/orgdet.cfm?orgid=13; Internet; accessed 26 April 2004.

¹⁷⁰ Department of State, Office of the Coordinator for Counterterrorism, *Patterns of Global Terrorism 2002* (Washington, D.C., April 2003), 77.

¹⁷¹ Scott Wilson, “A Transfer of Power in Colombia: Paramilitary’s Rise Unintended Outcome of U.S. Assistance,” *Washington Post Foreign Service*, 27 December 2001, 2; available from

The number of personnel and sympathizers: These are the actual workers and operators for the group, both active and “sleeper.” This bears more upon the number of operations a group may undertake than the type of operations. The size of a group in terms of the number of personnel is important, but less so than other aspects of support. A small, well-funded, highly trained group may effectively attack targets in CONUS, whereas a larger, poorly funded, untrained group may be no direct threat to U.S. targets other than those in immediate proximity to its base area of operations. For instance, the Japanese Red Army (JRA) conducted numerous attacks around the world in the 1970s, including an attempted takeover of the U.S. Embassy in Kuala Lumpur. In 1988, the JRA was suspected of bombing a USO club in Naples, where 5 people were killed, including a U.S. servicewoman. Concurrent with this attack in Naples, a JRA operative was arrested with explosives on the New Jersey Turnpike, apparently planning an attack to coincide with the attack of the USO. Although the JRA conducted attacks around the world, the JRA only has six hard-core members, and at its peak, only had 30-40 members.¹⁷²

Training

Training is the level of proficiency with tactics, techniques, technology and weapons useful to terrorist operations. It measures the abilities of a group in terms of specific operations and activities that threaten friendly forces. Keep in mind that innovative application of tactics can render moderately innocuous activities threatening. For example, the ability to stage a peaceful demonstration may be used to set the conditions for a riot that will provide cover for sniper assassinations of responding security forces.

The proliferation of expertise and technology has enabled groups that do not possess particular skills to obtain them relatively rapidly. In addition to the number of terrorists and terror groups that are willing and available to exchange training with one another, there are also experts in the technical, scientific, operational, and intelligence fields willing to provide training or augment operational capabilities for the right price.

Al Qaeda is well known for its extensive training. They have assembled thousands of pages of written training material and hundreds of hours of training videos. Training tapes have shown al Qaeda operatives conducting live fire exercises for a number of scenarios. These scenarios include assassinations, kidnappings, bombings, and small unit raids on various types of targets. Additionally, they conduct detailed planning, diagramming, and walk-through rehearsals prior to the actual live-fire exercise.

In the technology area, Aum Shinrikyo, has demonstrated its ability with chemicals and biological agents. It's most notable terrorist action was the release of sarin gas in five different subway trains in Tokyo in March 1995. However, it had released sarin previously in a Matsumoto residential area in June 1994. The cult has also cultured and experimented with

http://www.colhrnet.igc.org/newitems/may02/wp_transfer_power_27dec01.htm; Internet; accessed 26 April 2004.

¹⁷² Department of State, Office of the Coordinator for Counterterrorism, *Patterns of Global Terrorism 2002* (Washington, D.C., April 2003), 137.

numerous biological agents, to include botulin toxin, anthrax, cholera, and Q fever. Fortunately they were unsuccessful.¹⁷³

Operational Presence

This indicates where a group can operate, and what limits there are to expansion of its operational area. It considers the physical locations of a group's assets, and the capability to move and conduct activities beyond those locations. Although the physical presence of group members is an important factor for determining operational presence, it must be noted that a terrorist cell can have a variety of functions, and not all cells have direct action capability. Many terrorist organizations have extensive support networks within the continental United States, but have not developed an operational capability to match. Their infrastructure within the U.S. is designed primarily to acquire funding and equipment. Yet they could contribute to a rapid expansion of operational capability into the U.S. if required.

For most groups today, their operational presence is determined by their strategic goals, operational objectives, and funding levels, rather than by physical constraints such as geographical distance. Terrorists have exploited the increasing economic, information, and transportation linkages around the globe to expand their presence. The tools available to terrorists to defeat travel controls include support or sponsorship from rogue states, alliances with criminal trafficking and smuggling networks, technologically enhanced forging operations, and simple bribery.

Weapons and Equipment

The weaponry and equipment available is an important part of any capabilities assessment of organizations that use violence. A separate measure of these categories has not been included in our measures above due to the rapidity of change in this area, and the relation of weapons and equipment capabilities to financial strength. Whereas conventional military organizations rely upon standardization, and often have the problem of "legacy" systems that must be used in lieu of the most modern technologies, terrorists rely upon weapons and equipment tailored to each new operational requirement. If a simple weapon such as a RPG-7 will do the job, it will be used. If not, an appropriate system will be purchased. Since terrorists do not have to go through long acquisition processes like conventional militaries, their only limitation in obtaining state-of-the-art systems is financing, availability of the equipment, and training.

Terrorists use a broad range of weapons. Virtually any type of firearm can be employed, plus a wide variety of improvised explosive devices and conventional military munitions that are adapted for use for specific operational requirements. Additionally, some terrorists have employed both chemical and biological agents. Appendices D-G are provided as an introduction to various types of terrorist weaponry and their attack capabilities.

¹⁷³ Kyle B. Olson, "Aum Shinrikyo: Once and Future Threat?" *Emerging Infectious Diseases*, no. 4 (July-August 1999): 513-514.

Proxies

Terrorist capabilities are solely a function of the individual group or organization. As previously mentioned, many groups maintain links to rogue states, criminal gangs, activist groups, and other organizations that can expand their capabilities. This expansion may exceed the traditional areas of training and logistic assistance. It can include the actual conduct of operations, with one group acting as a proxy for the other. This is extremely dangerous, as it grafts the motivation and objectives of the group requesting an operation onto the capabilities and characteristics of the organization executing the operation.

Revolutionary groups such as the Baader-Meinhof Gang and the JRA provided operational personnel or undertook specific missions for Palestinian groups in the 1970s in exchange for training and support. Iraqi efforts to instigate terrorist activities as part of their strategy during the Gulf War¹⁷⁴ have been mentioned previously. Many of these attacks were instigated out of shared anti-U.S. objectives, whereas others were in exchange for the support Iraq provided the terrorist groups. In many cases there were previous linkages, and due to the expectation that Iraq would attempt to use the terrorism weapon, security and counter-terrorism forces were alert to these proxy activities.

While proxies generally share some goals or ideological basis with their sponsors or clients, this need not be the case. Purely mercenary proxy operations are possible, and sometimes even ideological opposites can find points where they can cooperate. The American Neo-Nazi and Christian Identity movements would seem to have nothing in common with Islamic fundamentalist groups, but in fact they have been cautiously exploring their shared anti-Semitism. Under the right conditions, this may prove to be enough agreement to lead to a proxy relationship.

For U.S. military forces, the most significant threat from a proxy attack is similar to the Gulf War scenario discussed above. A local or regional terrorist group could accept incentives to strike U.S. staging areas inaccessible to a hostile power against which the U.S. is deploying. Unlike Desert Storm, it is likely that some of these terrorist operations in the future will take place against units and facilities within the U.S. itself.

Conclusion

In this chapter we placed the threat to U.S. forces in a conceptual framework that allows unit planners and leaders to organize and interpret the threat information available to them. We have shown some of the motivations and objectives that exist for attacking military targets, and introduced a method of understanding terrorist organizations in a militarily useful manner. In Chapter 5 we will look at the various categories of U.S. military forces in relation to terrorist threats.

¹⁷⁴ Christopher C. Harmon, *Terrorism Today* (London: Frank Cass Publishers, 2000; reprint, Portland: Frank Cass Publishers, 2001), 52.

Page Intentionally Blank

Chapter 5

Terrorist Targeting of U.S. Military Forces

This chapter examines the threats to U.S. military forces. The intention is to provide a survey of likely terrorist actions. The descriptions are neither a region specific intelligence product nor an exhaustive list of terrorist scenarios, but does present techniques that have been used against U.S. forces in particular situations. Assessment and insight may assist risk management and situational awareness of potential terrorist activities.

Reviewing the 2004 casualty statistics from terrorist operations in 2003, there was an increase of nearly 140% in total casualties from 2002. Of the 4,271 casualties in 2003, the military accounted for 1% of the worldwide figures. Although this is relatively small compared to the large number of casualties in the “other” category (primarily civilians), Chart 5-1 demonstrates that government targets, which include the military, are definite objectives of terrorist attacks. Further, despite only three attacks directed at military facilities, versus 15 at diplomatic targets, military casualties exceeded diplomatic casualties by over five-to-one.¹⁷⁵ This indicates a significantly higher casualty rate per attack for military targets.

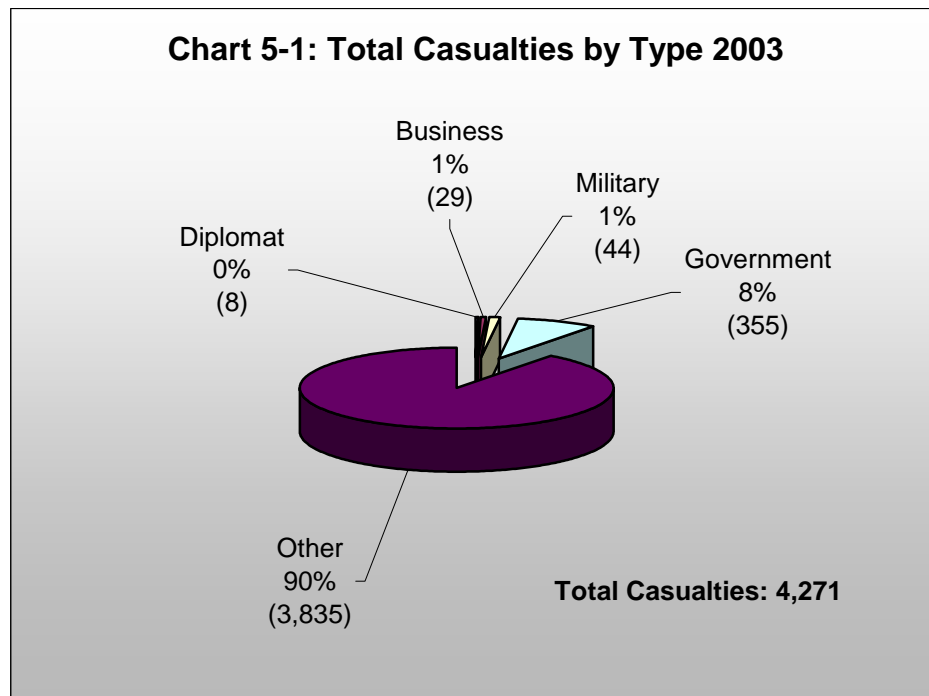

The 2004 data analyzed in 2005 cannot be compared to the previous year's information in *Patterns of Global Terrorism*. Starting in 2005, the National Counterterrorism Center (NCTC) provides a chronology of international terrorism, *A Chronology of Significant International Terrorism for 2004*, but qualifies that this chronology is not a complete accountability of

¹⁷⁵ Department of State, Office of the Coordinator for Counterterrorism, *Patterns of Global Terrorism 2003* (Washington, D.C., April 2004, revised 22 June 2004), 5.

global terrorist activity. The NCTC also cautions against using incident data alone to gauge success in the War on Terrorism. Criteria for qualifying incidents in this 2005 report have many conditions that include political, religious, philosophical, and cultural motivations; noncombatant definitions; and types of criminal actions that are excluded. Notwithstanding, data in the report and how terrorist attacks were conducted may include incidents against members of the U.S. Armed Forces, and civilians and police, outside of war zones or warlike settings. For a perspective on methods used in the 64 significant international terrorists attacks involving U.S. citizens or U.S. facilities in 2004, the National Counterterrorism Center's *A Chronology of Significant International Terrorism for 2004* presents numbers and percentages that indicate bombing and armed attack are the most common methods. Kidnapping is the next most recurring method.¹⁷⁶

Section I: Categories of U.S. Forces

In discussing the likelihood of particular threats to U.S. forces, situations are grouped in a simple classification of a military unit as deployed, in-, or institutional -- an organization that is nondeployable and operates permanently from a fixed location such as an installation or base. This system was used since terrorist targeting of U.S. vulnerabilities may be more concerned with the situational context of the unit at a particular place and time than with the unit's mission. Sections II through IV discuss each situation in detail.

Deployed Forces

This category consists of units that are deployed to locations other than their permanent base. Units that are normally stationed in Germany or Korea do not fit in this category. Because they are located overseas in those countries, U.S. forces have the infrastructure and local familiarity similar to a unit located at a continental U.S. (CONUS) post, base, or installation.

Deployed units are assumed to be operating away from their permanent bases, on either operational missions or training exercises. This category includes named contingency operations, fixed rotations into stability operations, and training assistance to foreign militaries, but is not intended to address individual assignments to overseas locations such as attaches or foreign study students.

In Transit Forces (Deploying or Redeploying)

These units are either preparing for or in the process of deployment and redeployment operations. This includes active component units within CONUS or permanently based overseas, even if not currently identified for movement, and reserve component units that are identified for named operations or notified for mobilization.

¹⁷⁶ National Counterterrorism Center, *A Chronology of Significant International Terrorism*, "Statistics on Significant International Terrorism," 27 April 2005, 85.

Institutional (Non-Deployable) Forces

These are active and reserve component garrisons, training and logistic facilities, and other activities and installations that do not deploy to accomplish their organizational mission.

Section II: Terrorist Threat to Deployed Forces

In this chapter, risk to deployed forces is identified as primary, potential, and possible threats. These threats are expressed in general terms without actual terrorist group names, but include likely tactics, techniques, and procedures used against U.S. forces. Within this concept, terrorists understand normal measures of U.S. forces operational security and force protection.

Environments and Conditions

Terrorists prefer to function in environments that reinforce their strengths and negate enemy advantages. They want to maintain secrecy while discovering enemy information, and focus on their objective while denying their adversary a concentration to strike and achieve surprise. In some cases urban terrain favors the terrorist in accomplishing these ends. Cities provide the terrorist with a population to conceal personnel, structures and facilities to hide and store equipment or weapons, and transportation nodes for movement.

One example of terrorism in an urban environment is the Algerian quest for sovereignty in a violent period of post-World War II nationalism. (See text box below) Regardless of the locale, terrorists will try to choose environments that are familiar to the terrorist but are unfamiliar to U.S. forces. Additionally, terrain and locations that restrict the full use of military capabilities can be used to the terrorist advantage.

Terrorists prefer an environment that is chaotic. A fluid, poorly policed or uncontrolled situation often permits suspicious activities to go unnoticed. As a norm, terrorists prefer that the

The Impact of Martial Law The Battle of Algiers

In the post-WWII surge of nationalist insurrections, the most notorious use of military authority to combat terrorism was the campaign waged by the French 10th Colonial Parachute Division against the urban terrorists of the Algerian insurgent movement FLN in the capital city of Algiers.

Algeria was one of the French colonies expecting to gain increased local rule, or perhaps independence, in the aftermath of WWII. When this did not occur, a nationalist insurgency began. By 1957 the nationalist groups, particularly the FLN, had been successfully carrying out a campaign of intimidation and terror that they felt would drive the French out of Algeria. The French responded by allowing the Army, in the person of General Massu and his *paras* [soldiers], to employ legalized barbarity against the FLN and suspected sympathizers. This included torture, mutilation, and murder.

The resulting campaign of terror and counter-terror has become known as the "Battle of Algiers," as much of the activity was initially concentrated in the capital city. While the French military scored significant successes, and broke the terrorist and guerilla forces in battle, they lost the war. Political support for the brutal suppression of the Algerians was eventually lost which directly contributed to the fall of the French constitution. After two attempted coups by French colonists in Algeria fearing that the mother country [France] was giving in, France finally granted Algerian independence in 1962.

environment is not completely or continuously hostile. Hostile environments put military forces on their guard, reduce the opportunities to get close to targets without being challenged or detained, and increase the difficulty of achieving any degree of operational surprise.

Terrorist groups will normally avoid operating as terrorists within actual combat-like environments. Doing so negates advantages and allows significant military strength to be used against terrorist operations. These capabilities include battlefield intelligence and detection systems, weapons firepower, and reduced legal constraints on the use of force and the authority to arrest and detain, such as martial law or some variation of control.

However, terrorist operations can be successful during close combat operations. Chechen terrorists and paramilitary forces added psychological stress to Russian conventional operations in 1994-1995 during the attacks in the Grozny region. Separating terrorist activities from military action was difficult as tanker trucks were booby-trapped with explosives, roads were mined, and civilians were held hostage. Chechens were sent to misinform Russian forces about Chechen tactical plans, while some Chechens acted as a network of informers on Russian movements. Reports spoke of Chechen men and women swearing an oath to commit subversive and terrorist actions in far away Moscow.¹⁷⁷ Examples of terror and counter-terror among military, paramilitary, and civilian populations are not unique to the Chechen issue.

Terrorists may use the advantages of surprise and security by hiding within a population. Sometimes terrorists may forego specific terror activities and operate as guerillas in areas of active combat operations. They can also operate as part of an insurgency force in combat operations. In Operation Iraqi Freedom, al Qaeda or foreign terrorists associated with al Qaeda have been involved in insurgency operations in Iraq since the inception of the war.

Terrorists know that deployed military forces will usually operate in one of two general environments of base camps or tactical (field) locations. Base camps are characterized by fixed facilities, either constructed or requisitioned, to provide shelter, support, and defensive capabilities to the units operating from them. This may include fixed airfields and port facilities. Base camps of military forces provide a much more stable and predictable target for terrorist planning. Of note, terrorist attacks carried out on U.S. units in Beirut (1983) and Khobar Towers in Saudi Arabia (1996) were in fixed billeting areas attacked by “purpose built” vehicle-borne improvised explosive devices (VBIEDs).

Tactical environments are considered to be those where the unit operates with only organic support in the field and no fixed facilities other than what the unit can improvise or what structures happen to be on the terrain. Units in tactical conditions have experienced casualties from gunfire and explosives but nothing comparable to the damage to the fixed facilities and related deaths of military members and civilians.

Terrorist incidents such as the sea-surface bombing of the USS *Cole* (2000) in Yemen illustrate the innovation of tactics and techniques against naval forces. Although Aden Harbor was not a permanent facility, the USS *Cole* was moored to a fixed refueling facility while in transit to its operational mission area. The Navy had been using the harbor for over a year for

¹⁷⁷ Alan C. Lowe, “Todo o Nada: Montoneros Versus the Army: Urban Terrorism in Argentina,” ed. William G. Robertson and Lawrence A. Yates, in *Block by Block: The Challenges of Urban Operations* (Fort Leavenworth, KS: U.S. Army Command and General Staff College Press, 2003), 176-177.

refueling operations. Terrorists had been conducting surveillance of these types of refueling operations and knew how long the ship would probably be in a fixed position in order to conduct a bomb attack.

Although deployed U.S. forces will be located in areas that are conducive, at times, to terrorist operations, these same forces have some advantages that can mitigate the risks of being targeted for terrorist operations. Several significant aspects are as follow:

- They are typically in a significantly enhanced force protection posture. Higher levels of alertness, control of approaches and access routes, and implementation of defensive measures reduce the likelihood of terrorist success, increase the costs to an attacker, and mitigate damage from successful attacks.
- They conduct appropriate planning and training to defeat or control hostile action. While this preparation may not specifically address terrorism, it does increase the probability of effective defense against attack, and reduces the casualties and damage if an attack should occur.
- Deployed units typically have increased access to intelligence assets and products. This information increases the effectiveness of the unit's own intelligence, counter-intelligence, and force protection efforts.

Primary Threats

The primary threats to deployed forces will normally come from existing in-theater terrorist groups. This will often be in response to the U.S. military presence, or an attempt to influence U.S. policies in a region. Terrorist groups may try to minimize their movement of personnel

and equipment into the area of operations after the arrival of U.S. forces to avoid detection. Whenever possible they will attempt to pre-position operational assets.



Figure 5-1. **Khobar Towers Dhahran, 1996**
(Source: DOD Photo)

A most dangerous form of attack historically used against deployed U.S. forces is the large vehicle-borne improvised explosive device (VBIED). This tactic has been used primarily against units in a base camp environment. The setback and protection common to deployed unit perimeters requires a powerful weapon to produce the large number of casualties and blast effects the terrorists want to achieve. A means to

deliver adequate explosive weight to offset or negate layered security measures is a vehicle. VBIEDs equaling thousands of pounds of explosive power can produce the blast wave and secondary missile effects needed to cross security distances and still cause

significant damage. The Khobar Towers VBIED was estimated to be the explosive equivalent of 20,000 pounds of TNT.¹⁷⁸ Table E-2 in Appendix E has a DOD chart that details the various size explosive devices with their comparable evacuation distances to avoid casualties.

A report in April 2004 by Jordanian intelligence indicated they thwarted an al Qaeda plan to detonate a large bomb in Amman with chemical weapon effects. The attack was targeting the Jordanian intelligence headquarters, as well as the U.S. Embassy and Jordanian prime minister's office. The exact type of bomb device was not disclosed, however, initial on-site estimates stated that tens of thousands of people could have been killed by this attack. Several trucks were seized with modified plows and several tons of explosives and chemicals. Several terrorists were killed or captured. The planned tactics indicate terrorists would ram through barriers and detonate the explosives near or at buildings for optimum effects. Subsequent analysis of the incident questions whether the chemicals were intended for use as a chemical weapon or as a means to increase the damage of a conventional explosion.¹⁷⁹

While possible that a unit in a field environment would be attacked by a large VBIED, it is much less likely than attacking a fixed facility. Preparation and deployment of such a weapon requires time that would likely be wasted if the target unit moved or improved its positions. This does not rule out the use of smaller IED weapons with faster preparation cycles if they can be effectively delivered and detonated. Lapses in security procedures, insufficient distance of personnel and facilities from a security perimeter, or habitually assembling units (convoys, patrols, road marches, etc.) in unsecured locations outside perimeters will be observed by terrorists as they seek a key vulnerability in security.

Delivering either a large or small explosive device by means of a suicide asset may or may not increase the effectiveness of such a weapon. The attack on the U.S. Marine Corps barracks in Beirut illustrates a successfully executed technique against a fixed facility. The suicide driver breached the gate and delivered the VBIED directly to the target. In this case, the use of a suicide bomber increased the probability and eventual effectiveness of the attack.

Conversely, at the Khobar Towers complex in Saudi Arabia, the vehicle access point was not considered an acceptable risk for breaching with a VBIED. Therefore, terrorists selected a point on the perimeter closest to the target buildings and people that allowed easy positioning of the VBIED, and a quick escape for the terrorists before the bomb exploded.

Variations of suicide attacks have been used to defeat specific perimeter security positions. One suicide asset acts as a breaching element in the first assault of a point. A second suicide asset follows immediately through the breach as an assault team with supporting fire from overwatch positions. This suicide element detonates the bomb to destroy a key target concentration within the target area.¹⁸⁰

¹⁷⁸ Department of Defense, *Report on Personal Accountability for Force Protection at Khobar Towers*, by William S. Cohen, (Washington, D.C., July 31, 1997), 2.

¹⁷⁹ *CNN.com*, 26 April 2004, "Jordan says major al Qaeda plot disrupted," available from <http://www.cnn.com/2004/WORLD/meast/04/26/jordan.terror>; Internet; accessed 9 August 2005, 1-3.

¹⁸⁰ Rohan Gunaratna, "Suicide Terrorism in Sri Lanka and India," in *Countering Suicide Terrorism* (Herzliya, Israel: Interdisciplinary Center Projects Publishing House, 2002), 107.

The most common form of attack used against deployed forces is the light weapons ambush, involving grenades, small arms, light bombs, and rocket launchers.¹⁸¹ Additionally, IEDs are being used more often in these type attacks. These attacks have successfully caused U.S. military casualties and gained recurring international media coverage. They are the easiest and quickest type of attack to plan and stage.

The light weapons type of attack described above may be deliberately launched from a group of civilians. Attacks by combatants in civilian clothes can merge into civilian crowds. Attack may come from the cover of civilian centers like mosques, schools, or hospitals as occurred repeatedly during Operation Iraqi Freedom (OIF). This provides concealment for terrorists, as well as complicating a reaction from U.S. forces, since engaging a combatant, when shielded by non-combatants, could result in civilian casualties. Terrorists exploit civilian casualties for publicity and propaganda value. If the U.S. forces attempt to apprehend or neutralize an attacker without inflicting collateral non-combatant casualties, the U.S. action may be ineffective and expose the force to other attackers concealed within the group anticipating the U.S. attempt to limit civilian casualties.

In assessing the terrorist threat to a deployed force in a particular area of operations, the effectiveness of poorly resourced local groups should not be underestimated. Capabilities in terrorist organizations can differ significantly in their effects. Combined with intent and resolve, terrorist acts can be a major influence on U.S. national level decisionmaking on reinforcement or removal of U.S. forces from areas, as demonstrated in Beirut (1983) and Somalia (1992). While Somalia was not the result of planned terrorist action, the exploitation of the casualties and psychological impact from the failed U.S. mission are classic terrorist media techniques. "Actors" from outside the immediate area of operations supported U.S. adversaries in both of these incidents. Further, Somalia demonstrated the prestige that can be associated with successfully challenging U.S. forces, and bring benefits to the groups involved through increased support and improved perception by the local populace. These positive results become incentives for further attacks.

Potential Threats

Less likely than attacks by the existing in-theater groups are attacks by organizations that cannot otherwise reach U.S. targets either in CONUS or in other overseas areas. These groups will take the opportunity to attack U.S. military forces exposed in a third country. This can happen even if the U.S. forces are not a direct threat to the terrorist group, or are not conducting activities that are "objectionable" to the terrorists. The terrorists' attraction to the opportunity target of U.S. forces in a country that is a "permissive environment" is obvious. Such a country could be one with poor border control, a weak or unstable government, and easy access to weapons or smuggling routes. An attack could be exploited for objectives unrelated to the actual U.S. military mission.

In these circumstances the target of the attack may be more symbolic such as striking at significant individuals occupying positions of power or influence. Targeting senior

¹⁸¹ Christopher C. Harmon, *Terrorism Today* (London: Frank Cass Publishers, 2000; reprint, Portland: Frank Cass Publishers, 2001), 160.

commanders, particularly while in transit to or from a deployed unit in a permissive or exposed environment has been a frequent objective of terrorists. Attempted assassinations of key unit personnel should be considered a distinct possibility, with any number of methods available to the terrorist.

An example of this sort of target of opportunity operation was the bombing of the USS *Cole* in Aden harbor in October of 2000.¹⁸² The presence of the USS *Cole* was unwelcome to extremists who conducted the attack, and the situation created an opportunity for terrorist attack. The USS *Cole* was no direct threat to terrorist organizations ashore, and the refueling operation conducted in Aden was specifically meant to be unobtrusive to local sensibilities. However, the vulnerability of the ship indicated a high probability of success against an obvious symbol of the United States. Although the terrorist intention was probably to sink the warship, the resulting casualties and images of the damaged warship accomplished publicity and a psychological message on an international and worldwide audience.



Figure 5-2. **Suicide Bomb Damage to USS *Cole*.**
(Source: U.S. Navy)

The USS *Cole* bombing in 2000 used another VBIED, the vehicle in this case being a boat. Deployed forces should not ignore the possibility of explosive devices or other attack methods being delivered by boat or air. Various groups employed ultralight aircraft, powered and unpowered hang gliders, small civilian aircraft, and remote control aircraft to deliver attack teams, explosives, or suicide bombers to particular targets.¹⁸³ A unit that successfully interdicts or controls all surface approaches should neglect neither the possibility of an aerial approach, nor assume that control of surface approaches is sufficient. The Tamil Tigers (LTTE) have used suicide and remote controlled explosive motorboats against Sri Lankan government targets. In 2000, they used suicide stealth boats to destroy a Sri Lankan fast personnel carrier and damage another boat. Also in 2002, a Palestinian suicide boat, a fishing

¹⁸² John McWethy et al., no title, *ABCNews.Com*, (18 October 2000); available from <http://www.abcnews.go.com/sections/world/DailyNews/cole001018b.html>; Internet; accessed 9 January 2003.

¹⁸³ Christopher C. Harmon, *Terrorism Today* (London: Frank Cass Publishers, 2000; reprint, Portland: Frank Cass Publishers, 2001), 165.

boat packed with explosives,¹⁸⁴ intending to sink an Israeli naval craft exploded prematurely with insignificant damage to the Israeli craft.¹⁸⁵

Several terrorist groups have successfully utilized divers in underwater infiltrations and attacks. In 1975, the *Montoneros* terrorists in Argentina severely damaged the Argentine Navy's first modern missile-carrying frigate, the *Santísima Trinidad*. Divers approached the frigate in a camouflaged boat, attached underwater demolition charges to the ship's hull as it berthed in a naval shipyard under guard. The damage caused by the explosion delayed the ship's operational deployment for at least one year. A corresponding psychological impact accented a loss of confidence by the public in national military affairs.¹⁸⁶ In recent years, Israel has encountered terrorist divers attempting to enter through the sea.¹⁸⁷ Indicators point to subsurface terrorist attack as a recurring threat. Abu Sayaff terrorists kidnapped a diving instructor and demanded diving lessons. Similarly, a group of men approached a diving school in Kuala Lumpur to learn about underwater maneuvers but were uninterested in learning the skill of decompression when resurfacing.¹⁸⁸

A potential threat that has been employed against other nations' military forces with some success is the capture or kidnap of small units or individuals on missions that isolate them from the larger unit. The individual soldiers may be used as hostages, tortured, or killed for psychological effect. U.S. prisoners of war found themselves used as human shields, hostages, and worse in previous conventional conflicts. However, a recent example of this type of threat is the kidnapping and alleged killing of an American soldier in Iraq in June 2004. Specialist Keith Maupin was captured during an ambush on a convoy in April 2004 and had been held hostage for nearly three months. The Arabic television station Al-Jazeera initially aired a video showing Maupin in captivity on April 16, 2004. In June 2004 Al-Jazeera reported that Maupin had been killed by his captors. The television station aired a video showing a blindfolded man, allegedly Specialist Maupin, sitting on the ground. Al-Jazeera said that in the next scene, gunmen shot the man in the back of the head, in front of a hole dug in the ground. The hostage-takers' statement claimed that Maupin had been executed "because the United States hasn't changed its policy on Iraq and to avenge our martyrs in Iraq, Algeria and Saudi Arabia," according to Al-Jazeera.

Individual U.S. government and military personnel have been kidnapped and exploited by terrorists when serving on individual missions overseas. In 1981, members of the Red Brigades abducted U.S. Army Brigadier General James Dozier in Verona, Italy. Terrorists

¹⁸⁴ "Fishing boat explodes near Israeli vessel," CNN.com./WORLD (22 November 2002); available from <http://www.cnn.com/2002/WORLD/meast/11/22/mideast/>; Internet; accessed 21 January 2004.

¹⁸⁵ "The asymmetric threat from maritime terrorism," [database on-line]; available from http://jfs.janes.com/public/jfs/additional_info.shtml; Internet; accessed 2 February 2004.

¹⁸⁶ Alan C. Lowe, "Todo o Nada: Montoneros Versus the Army: Urban Terrorism in Argentina," ed. William G. Robertson and Lawrence A. Yates, in *Block by Block: The Challenges of Urban Operations* (Fort Leavenworth, KS: U.S. Army Command and General Staff College Press, 2003), 395.

¹⁸⁷ "CAMERA ALERT: CBS' 60 Minutes Exposes 'The Arafat Papers,'" Committee for Accuracy in Middle East Reporting in America; available from http://www.camera.org/index.asp?x_article=289&x_context=3; Internet; accessed 2 February 2004.

¹⁸⁸ Shefali Rekhi, "Next terror target," *Straits Times Interactive* (16 October 2003); available from <http://www.google.com/search?hl=en&lr=&ie=UTF-8&q=terro+AND+attack+AND=underwater&btnG=Google+Search>; Internet; accessed 21 January 2004.

entered the Dozier's apartment, tied up his wife, and departed with General Dozier.¹⁸⁹ Stuffing Dozier into a trunk, the terrorists drove away in a car and hid Dozier in a safehouse. Eventually, they released a photograph to the media of a bruised and battered Dozier. With significant U.S. intelligence and Italian anti-terrorist investigation, an elite Italian anti-terrorism police unit rescued Dozier in a surprise assault on the safehouse.¹⁹⁰

The uses of "atrocious videos", such as showing the torture and murder of prisoners in the Balkan, Algerian, and Afghan (Soviet) conflicts, are becoming common practice among terrorist organizations to attract and indoctrinate recruits, and terrify the opposition.¹⁹¹ In May and June 2004, the gruesome beheadings of two Americans and one Korean by terrorists and the display of the murder on the Internet is a clear indicator that this tactic will continue to be used to exploit captured personnel for terror effects.

Other Possible Threats

Other possible threats include provocations by external or internal politically affiliated terrorist groups to induce U.S. action to achieve a desired outcome. In the Balkans, for example, the various ethnic and religious factions continually attempt to blame each other for harassment, graffiti, arson, and drive-by shootings. In fact, some groups would carry out incidents against their own property and people, and attempt to implicate their opponents to provide a suitable cause for SFOR (Stabilization Force) involvement.¹⁹² Their goal was to provoke SFOR into suppressive action against their enemies.

Another potential threat is the possibility of punitive attacks against family members of forward deployed personnel. This could be either retaliation for actions taken by U.S. forces, or a preemptive action designed to lower morale and decrease unit effectiveness. It could also be intended to provoke reprisals by U.S. soldiers against civilians in the area of operations.

Such attacks would depend upon the operational reach of the terrorist adversary, or their ability to engage a proxy organization to conduct such an operation for them. If actual attacks are impractical, threatening messages directed at family members could be employed to erode soldier confidence and morale. Falsified emergency notifications and Red Cross messages could be employed to the same effect. In fact, during OIF there were a number of cases where families received false notification that their relatives had either been captured or killed. In one week in April 2003, callers posing as American Red Cross workers informed family members in California, Delaware, Michigan, and Alabama that their family member had been killed in Iraq.¹⁹³ Although these examples may not be terrorist inspired, the issue of

¹⁸⁹ "Red Brigades Kidnap an American General in Verona," *New York Times*, 18 December 1981.

¹⁹⁰ "Operation Winter Harvest: The Rescue of Brigadier James Dozier," *Special Operations. Com*; [database online]; available from <http://www.specialoperations.com/Counterterrorism/Dozier.html>; Internet; accessed 26 February 2004.

¹⁹¹ Jason Burke, "You Have to Kill in the Name of Allah until You are Killed," *Guardian Unlimited* (Observer Special Report, 27 January 2002), 3; available from <http://www.observer.co.uk/islam/story/0,1442,640288,00.html>; Internet; accessed 15 January 2003.

¹⁹² Department of Defense, *11th Psychological Operations Task Force After Action Report for SFOR X*, by MAJ Clint A. Venekamp, (Upper Marboro, MD, July 2002).

¹⁹³ "False Calls on Casualties Upset Camp Pendleton Spouses," *Mustang Daily Online News*, 11 April 2003; available from <http://www.mustangdaily.calpoly.edu/archive/20030411/print.php?story=inat>; Internet; accessed 13 August 2004.

harassment and threats, as well as physical violence, can further stress an environment already experiencing fear and anxiety.

Preventative Measures

The greatest deterrent to terrorist action is aggressive operations security (OPSEC) programs emphasizing surveillance detection and counter-intelligence activities. While physical security measures are essential, they can be neutralized or avoided by terrorists with adequate preparation. Terrorists must have superior target intelligence to select targets, circumvent security, and plan operations. Deny them this information, and they cannot operate effectively. Detecting them collecting target data permits anticipation of possible terrorist courses of action.

Information the deployed unit should consider obtaining includes any record of surveillance incidents directed against U.S. diplomatic or commercial activities in the country. Correlation of confirmed surveillance against these potential targets permits a deployed unit to identify personnel, vehicles and techniques in use in that area prior to arrival. Terrorists have the capability to use sophisticated tradecraft that will complicate this correlation, but they have also been known to use the same personnel and vehicle repeatedly in surveillance tasks. The Khobar Towers pre-attack surveillance was conducted using one vehicle for all surveillance missions. That vehicle was observed and reported 10 times out of 40 separate uses as a surveillance platform.¹⁹⁴ Unfortunately, this information was not correlated and interpreted correctly by U.S. forces.

Unit planners should seek out any record of actual terrorist activities in the area, whether directed against U.S. interests or not, from intelligence, security and law enforcement sources. Additionally, groups or individuals considered dormant or inactive should be reviewed based upon the possible change in attitude or motivation that a U.S. deployment into the area might cause.

Variation of a unit's operational patterns is a basic but useful technique to deter attacks. It prevents anticipation of target actions by the terrorist(s); it introduces uncertainty to his planning, and sharpens the alertness and observations of unit personnel by avoiding routine. Terrorist operations have been called off, and attacks in progress have been "blown" due to simple changes in the routine or activity of a target.

This is by no means an exhaustive list of threats to deployed U.S. forces. Intelligence specific to the area of operations must be studied and integrated into realistic threat assessments for deployed units. However, terrorists have used the techniques mentioned in the scenarios discussed here multiple times against deployed military forces. These techniques will continue to be employed by terrorists in modified forms with innovations in weapons or tactics as long as they continue to be effective.

¹⁹⁴ Department of State, Bureau of Diplomatic Security, *State Department Diplomatic Security Surveillance Detection Program Course of Instruction* [CD-ROM], (Washington, D.C., October 1999).

Section III: Terrorist Threat to Deployable Forces

This section discusses likely threats to U.S. forces in the deployable category. “Deployable forces” are those units that are either preparing for or in the process of deployment and redeployment overseas. These units include active component units both within CONUS and permanently based overseas, (even if not currently identified for movement) and reserve component units that are identified for named operations or notified for mobilization. The purpose for identifying “deployable” units in this manner allows us to consider possible threats to a unit ranging from their home station to their debarkation point during a deployment. Additionally, this category addresses those threats directed at war fighting or operational units not immediately slated for movement. Installations will be discussed in Section IV.

Reserve component units identified for mobilization or participation in named operations fall into this category even though their deployment may not be imminent. This is because of the increase in training activity and resources they receive, as well as the possibility that their participation in a particular operation will motivate an attack. When discussing home station activities, attacks planned against off-duty personnel known to be military members are also considered.

Primary Threats

Threats to deployable U.S. forces, either at home station or in transit to and from an operational mission, may be from foreign or domestic terrorists. Foreign terrorist organizations will be international or transnational groups with either an operational presence already in the U.S., or support infrastructure in place to facilitate the arrival of operational assets. They will possibly be state sponsored organizations, or organizations operating for profit or for other material considerations on behalf of some government. In some cases they could be state intelligence or covert military special operations forces. Domestic terrorist groups may arise from any number of special interests with political, social, religious, or environmental focus. While in raw numbers of past incidents, domestic terror groups were responsible for more attacks and attempted attacks on U.S. military targets than external groups, most of these attacks were directed against facilities and installations, not units and personnel.

However, state sponsors or transnational terror groups may also use domestic groups that can be exploited through shared ideology or for monetary considerations to conduct operations in the U.S. against military targets. For instance, the El Rukns group, a Chicago based gang, negotiated with Libya to attack a domestic airliner with a surface to air missile in 1985.¹⁹⁵ Apparently, Libya postponed the attack when the group purchased a light anti-tank weapon from an undercover FBI agent. The group’s leader and six other El Rukns were arrested and subsequently convicted of conspiracy to commit terrorism. Libya also directed and sponsored lethal attacks by the Japanese Red Army (JRA) on U.S. military targets in CONUS and abroad during the same period of time.¹⁹⁶ In CONUS, a JRA member was apprehended in 1998 with three pipe bombs in his car, the target supposedly being a U.S. military base. In this

¹⁹⁵ Christopher C. Harmon, *Terrorism Today* (London: Frank Cass Publishers, 2000; reprint, Portland: Frank Cass Publishers, 2001), 162.

¹⁹⁶ Bruce Hoffman, *Inside Terrorism* (New York: Columbia University Press, 1998), 188-189. The JRA adopted the name “Anti-Imperialist International Brigades” for these operations.

case, Libya could probably have used a domestic U.S. group had one been available and capable. Overseas, a 1998 JRA bombing of a U.S. servicemen's club in Naples, Italy killed five people including a U.S. servicewoman. Although these examples occurred in the last two decades of the twentieth century, there is also evidence indicating that al Qaeda is subcontracting to like-minded terrorist groups to conduct operations.

Home Station Threats

Threats to deployable units at their home station during pre-deployment activities will most likely consist of attacks on units conducting movement to or from training activities, and attacks upon off duty personnel during social gatherings. The intent would be to demonstrate the capability to damage U.S. military forces, and weaken morale. The most likely methods of attack would be a small to medium size improvised explosive device (IED), or an ambush conducted with light weapons (automatic weapons, grenades, and anti-tank rockets).

Attacks on units training will most likely take place during movement because:

- The unit is concentrated during movement, and typically dispersed during training.
- Training areas are usually harder to access by non-military personnel than roads leading to or from them.
- Units training have a greater degree of alertness than units in an administrative road movement.
- Units conducting training have greater self-defense capabilities, especially if they are training with live ammunition.
- Routes to and from training areas are well established, almost habitual, whereas movement during training is more difficult to pattern.

Attacks on personnel at social gatherings can occur at clubs on post, or during unit functions at private homes or commercial establishments off post. Traditional observances of organizational days, town hall meetings, and family support briefings are often publicized in advance and give attackers planning dates for possible gatherings in accessible locations. Attacks at commercial entertainment establishments such as bars, clubs and restaurants off post are less likely because the density of military personnel at a particular establishment is usually not sufficient to gain the appropriate impact. The most likely attack method will be a small to medium sized IED, although terrorists may employ improvised mortars or other standoff weapons.

Deployment Preparation and Movement

Attacks on deployable units are likely to occur during actual preparation for deployment activities. The specific mission may inspire an attack by a group who wishes to prevent the deployment, or a potential adversary may attempt to extend the depth of the battlefield by engaging units with unconventional terrorist attacks before they arrive in theater. Objectives

of these attacks will depend on the mission of the deploying unit and the context of the mobilization, but may include:

- To delay or prevent mobilization or deployment.
- To render the unit non-mission capable for deployment.
- To decrease unit effectiveness when deployed.

Delay or Prevent Mobilization or Deployment

Operations aimed at this objective would involve either disrupting the unit enough to prevent its movement on schedule, or disrupting the transportation cycle for the unit. Disruptions sufficient to prevent the unit from making movement would probably also render it non-mission capable for deployment.

Disruption of transportation may take place by sabotage or direct attack upon the unit being transported and its conveyance. Methods of attack would be selected depending upon their effectiveness versus the mode of unit transport. Air, rail and sea are the modes of transport for long voyages, but frequently units must use ground conveyances such as buses or organic vehicles to get to their embarkation point. Consequently, attacks may also occur against these vehicular movements. Weapons likely to be employed include bombs, AT rockets, and potentially, guided missiles. If sabotage is used in preference to direct attack, the sabotage will be designed to produce maximum casualties in the ensuing crash, derailment, fire, etc. An example of this type threat was demonstrated in January 2003 when intelligence sources detected the targeting of chartered aircraft participating in the build up of forces against Iraq.¹⁹⁷ Additionally, domestic terrorists have derailed U.S. passenger and cargo trains,¹⁹⁸ and attacks on ships in port and at sea are well within the capabilities of most transnational and international terror groups.

Destroying facilities such as docks, airfields, refueling facilities, and cargo terminals at intermediate stops or at the final destination is another way for terrorists to prevent or delay deployment. Attacking critical private infrastructure, both through physical and cyber means, could cause similar effects. It is a method of adding depth to the battlefield during a conflict, and does not require the projection of assets and weapons into more distant countries. If timed to coincide with the arrival of incoming units, such destructive attacks could cause significant casualties. The *Montoneras* terrorists, having advanced from individual terrorist acts to paramilitary guerrilla operations, achieved significant psychological strikes to Argentine military forces using this type of attack against an air force airfield in 1975 with spectacular results. Placing explosives in an abandoned tunnel underneath the airfield runway, the bomb was detonated as a C-130 aircraft carrying an antiguerrilla unit was starting its departure. The C-130 was destroyed, resulting in four killed and forty injured, as well as damaging the

¹⁹⁷ Thom Shanker, "Officials Reveal Threat to Troops Deploying to Gulf," *New York Times*, 13 January 2003; available from <http://www.nytimes.com/2003/01/13/politics/13INTE.html>; Internet; accessed 13 January 2003.

¹⁹⁸ Jim Hill, "Sabotage Suspected in 'Terrorist' Derailment," *CNN.com*, 10 October 1995; available from <http://www.cnn.com/US/9510/amtrak/10-10/>; Internet; accessed 15 January 2003.

runway. At a minimum, this was a psychological blow to the Army's image with its nation, and a clear instance of a military force defeat.¹⁹⁹

Render the Unit Non-mission Capable for Deployment

The objective here is to cause sufficient damage or disruption to the unit so that it will be unable to deploy, or will be unable to function once deployed. The most direct way to do this is to inflict casualties on the unit. IEDs, rocket launchers, and mortars directed at unit assemblies such as formations, manifest calls, and other pre-deployment personnel concentrations are the most likely scenario. A terrorist group with a rudimentary biological weapons capability could infect enough of a unit with a contagious disease that it would have to undergo quarantine, delaying deployment. Additionally, terrorist capability and suspected or known intention to use biological weapons against U.S. military forces could cause extraordinary processes for vaccination of U.S. military forces. These additional preventive medicine and safety issues may result in longer deployment timeframes for U.S. military forces. The use of biological weapons is a less likely and somewhat uncertain proposal from the terrorist point of view, but could be used to bypass defenses designed to prevent other forms of attack. Additionally, given al Qaeda's statement that it is their "holy duty" to acquire weapons of mass destruction, it is clearly an option that terrorists are pursuing.

Another possibility to consider is the destruction of a key piece of equipment or the assassination of key personnel. This is less attractive to the terrorists because they cannot be sure that such losses would not be rapidly replaced. Unless the terrorist group is aware of specific personnel or equipment shortages, they will rely on the more certain method of mass casualties.

Decrease Unit Effectiveness When Deployed

This objective requires actions to undermine morale and destroy unit efficiency. It will be characterized by less lethal, more harassing activities. Contaminating unit equipment with low level radiation sources, infecting unit information processing equipment with viruses, harassing or attacking soldiers' family members, and inserting false messages of death or illness into the various notification systems to both family and service members are all possible scenarios. With the exception of actual attacks on service members' families, these activities do not require significant operational skill or resources.

Potential Threats

Home Station Vulnerabilities

Although less likely than transnational or international terrorists attacks, domestic groups who object to U.S. military involvement overseas, or to the political goals of U.S. policy still have potential to conduct attacks. Such groups would share the objectives listed above, with the further aim of publicizing the domestic dissent to the particular mission or policy. Such groups could develop capabilities very rapidly, and commit acts that disrupt, damage, or delay institutional support to military forces. Although they are nearer to the targets and less visible

¹⁹⁹ Alan C. Lowe, "Todo o Nada: Montoneros Versus the Army: Urban Terrorism in Argentina," ed. William G. Robertson and Lawrence A. Yates, in *Block by Block: The Challenges of Urban Operations* (Fort Leavenworth, KS: U.S. Army Command and General Staff College Press, 2003), 395.

to casual suspicions than foreign personnel, domestic terrorists would be constrained in conducting significant lethal attacks due to the possibility of severe backlash for actions against fellow citizens.²⁰⁰ Actions would probably start out with symbolic and non-lethal arson, vandalism, and sabotage. If these fail to ignite public support for the terrorists' goals, their organizations would increase in radicalization, and attacks would become more lethal, as happened in the Vietnam-era anti-war movement.²⁰¹ In 2003, a militant spokesperson openly recommended that like-minded supporters "...Actively target U.S. military establishments within the United States." Stated goals are to "...disrupt the war machine, the U.S. economy, and the overall functioning of U.S. society..."²⁰²

There is also the potential for domestic groups to attempt to obtain advanced military technology or new equipment by raiding units during normal training activities. This threat is most likely to come from groups who wish to rapidly increase their offensive capabilities in anticipation of paramilitary operations. Groups whose ideology emphasizes insurrection, social warfare, or "local" uprisings are most likely to attempt this type action. There are many examples of this threat in the United States. In the mid-1990s, a militia member in Florida was charged with planning to break into a National Guard armory to steal explosives and firearms. These capabilities were to assist his intention of blowing up power transmission lines that feed a large city and nuclear plant. The indictment also stated that the individual plotted to kill a militia member suspected to be an informant. Federal authorities seized rifles, handguns, and a large quantity of ammunition from the individual's home.²⁰³ Also in the mid 1990s, members of the Michigan Militia were apprehended with a car containing 700 rounds of ammunition, loaded rifles, night vision goggles, and other military-type equipment.²⁰⁴ In 2001, a white supremacist was charged with stockpiling bomb making materials and bank robbing. This individual also attempted to use counterfeit paper currency. A notebook at his lodging included recipes for bombs mixing fuel oil and fertilizer similar to the bomb used in the Oklahoma City bombing of the Murrah Federal Building.²⁰⁵

This domestic threat is not just limited to small explosives and firearms. In 2003, a Texas citizen pleaded guilty to possession of a weapon of mass destruction. In a Federal investigation that started due to finding false government identification badges, subsequent searches at the individual's home and storage facility uncovered a sodium-cyanide bomb

²⁰⁰ Walter Reich, ed., *Origins of Terrorism: Psychologies, Ideologies, Theologies, States of Mind*, rev. ed. (Washington: Woodrow Wilson Center Press, 1998), 94.

²⁰¹ *International Encyclopedia of Terrorism*, 1997 ed., s.v. "Student Terror: The Weathermen."

²⁰² Craig Rosenbraugh, "Craig Rosenbraugh on the Anti-War Struggle," *Houston Independent Media Center*, 17 March 2003; available from <http://houston.indymedia.org/news/2003/03/9125.php>; Internet; accessed 16 February 2004.

²⁰³ Larry Dougherty, "Indictment details plot to blow up power lines," *St. Petersburg Times*, 9 December 1999; available from http://www.sptimes.com/News/120999/TampaBay/Indictment_details_pl.shtml; Internet; accessed 16 February 2004.

²⁰⁴ Tom Burghardt, "Leaderless Resistance and the Oklahoma City Bombing," BACORR: Bay Area Coalition for Our Reproductive Rights; available from <http://nwcitizen.com/publicgood/reports/leadless.htm>; Internet; accessed 10 February 2004.

²⁰⁵ Shelley Murphy, "White Supremacist Accused of Targeting D.C. Museum," *Globe*, 20 September 2001; available from <http://www.rickross.com/reference/supremacists/supremacists57.html>; Internet; accessed 16 February 2004.

capable of killing thousands, a large amount of explosives, 500,000 rounds of ammunition, dozens of illegal weapons, and a large number of white supremacist and anti-government literature.²⁰⁶

Deployment Preparation and Movement

As discussed above, domestic groups who object to U.S. military activity or U.S. policy could conduct operations against deploying units. A key difference here is that attacks of this nature would probably start out at the lethal end of the spectrum. This is because the domestic groups are either conducting operations sponsored or directed by external actors, such as other terrorist groups or nations, or because imminent deployment would increase the sense of radicalization of these groups. Such groups would share the objectives for preventing or delaying unit movements discussed under “Probable Threats,” with the further aim of using such actions to publicize their dissent.

A particular specialty of domestic groups is their capability to conduct harassment campaigns against individuals peripherally associated with or employed by activities these groups object to. Such a campaign undertaken by a domestic group against service members’ families with the objective to reduce unit morale and effectiveness would be extremely disruptive. Harassment campaigns have included lethal and near lethal attacks, as well as disrupting the victim’s daily life and instilling constant, pervasive fear in the victim. Such a campaign added to the normal stresses associated to military careers and deployments could have extremely negative consequences in both the long and short term.

Possible Threats

Possible threats to both home station activities and deployment activities could come from U.S. resident aliens or citizens not specifically organized or affiliated with larger terrorist networks. These groups may have loyalties to ethnic, religious, or nationalist causes hostile to the U.S. or opposed to U.S. policies. Expatriate and immigrant ethnic groups threatened action against government and military targets in the U.S. and Europe when Stabilization Force (SFOR) activities or policies in Bosnia-Herzegovina were perceived as contrary to the best interest of their ethnic “home” state or group. Other immigrant and expatriate groups have provided support for various hostile activities directed against particular U.S. foreign policies. While largely unorganized, even individuals with little support but high motivation can have major impacts. Jordanian Sirhan Bishara Sirhan assassinated Senator Robert Kennedy in 1968 because of his assumption that Kennedy would likely be the next U.S. President, and he wished to prevent Kennedy’s expected support for Israel. Probably the best-known example of an individual domestic terrorist incident, though, is Timothy McVeigh’s bombing of the Murrah Federal Building in Oklahoma City. His hatred of the Federal Government and his belief that U.S. Government policies and practices were unjust and violated citizens’ Constitutional rights drove him to conduct this heinous act.

²⁰⁶ Kris Axtman, “The Terror Threat At Home, Often Overlooked,” *Christian Science Monitor*; 29 December 2003; available at <http://ebird.afis.osd.mil/ebfiles/s20031229244982.html>; Internet; accessed 29 December 2003.

Units Based Overseas

Units based in overseas locations have several special considerations. Because of different conditions outside of continental U.S. locations, their home station routine is more vulnerable to terrorist attack than similar units based inside the continental U.S. Europe is an excellent example where attacks on U.S. service members have been extensive and lethal.²⁰⁷ Some attacks were state sponsored or directed, which made them even more dangerous.²⁰⁸

There are two principal conditions contributing to the higher level of threat to overseas-based units. The first condition is exposure. Countries that have permissive border controls, countries that are located closer to states that harbor or sponsor terrorists, or that have active terrorist groups within their borders, all increase the ability of terrorists to reach U.S. military units and personnel based therein. This situation is best illustrated in Europe, where internal border control between European Union (EU) nations is no longer required. Once the borders of a EU member are penetrated, travel to all member countries becomes possible with minimal control. The proximity of the EU to states sponsoring terrorism is much greater than the U.S., and the smuggling and criminal trafficking routes used by terror groups pass through or close by EU nations. Additionally, several EU nations still have very capable terrorist organizations based within their borders.

Conditions may be posed by the host nation (HN) that constrains U.S. military forces from implementing force protection measures such as stand-off distance, barricades, and patrols outside a facility perimeter. U.S. military forces at Khobar Towers (1996) witnessed such constraints. Also, criminal organizations loosely or closely linked to terrorist groups, can cause dispersal of limited resources and capabilities such as U.S. military police, contracted security forces, or other anti- and counter-terrorism assets.

The second condition is visibility. U.S. military members are usually highly visible in overseas environments, particularly in countries that emphasize their homogeneity. This not only aids in targeting U.S. personnel; but also contributes to another kind of visibility - political visibility. U.S. military presence is frequently a contentious issue in local politics in host nations. This political visibility can lead to resentment of the U.S. presence, and ultimately to attacks against visible signs of that presence, such as military personnel. It is often difficult, though, to determine if a terrorist element or just political activists within the country instigate these attacks. Excellent examples are the common protests in South Korea against the presence of American troops in the country. One occurrence happened in November 2002, when South Korean activists hurled firebombs into a US military base in protest against the acquittal of two American soldiers who ran over and killed two South Korean girls. During the protests, American troops were kicked and beaten by the protesters before they could be contained.

The most common threat to overseas-based units is attacks directed against off-duty personnel, either at social gatherings or at entertainment establishments. This is different from the home station situation for CONUS based units because personnel overseas tend to cluster socially, frequenting particular establishments in large numbers. This density provides

²⁰⁷ *International Encyclopedia of Terrorism*, 1997 ed., s.v. "Chronology of Terrorist Events."

²⁰⁸ Christopher C. Harmon, *Terrorism Today* (London: Frank Cass Publishers, 2000; reprint, Portland: Frank Cass Publishers, 2001), 71.

sufficient military victims for the terrorist attack to achieve the desired effect. Also, significant civilian casualties can be exploited as a wedge issue, to be driven between the host nation populace and the U.S. military. To the terrorists, causing civilian casualties at a club in an American town would simply be more dead Americans. Attempting to instill negative feelings toward the military in the local community would be nearly impossible. However, dead civilians from a host nation can be “blamed” on the U.S. presence by the terrorists, and can raise the question in the host nation political system of the costs of hosting foreigners who are going to attract political violence to their communities. This specific threat was demonstrated in April 1988 when a car bomb exploded in front of the USO Club in Naples, Italy. The explosion resulted in the death of five people, including a U.S. servicewoman. Additionally, fifteen people were injured, including four U.S. servicemen. Junzo Okudaira, a Japanese Red Army (JRA) member, was indicted for the bombing.

Other attacks that have been conducted against units based overseas have principally involved rocket launchers, improvised mortars, and bombs directed against key leaders and on-duty personnel. These attacks have ranged from the low end of sophistication to highly technical operations. While unlikely, the possible use of chemical or biological weapons should be acknowledged. The 1995 Tokyo subway nerve agent attack was conducted by the Aum Shinrikyo cult, which was (and is) virulently anti-American. Aum Shinrikyo had a significant interest in all forms of WMDs, and in addition to the nerve agent Sarin, had several other types of chemical and biological weapons under development.²⁰⁹ Aum’s central philosophy focused on the inevitability of nuclear Armageddon, and the cult occasionally considered provoking such a conflict so they could fulfill their appointed role in such a disaster.

Vandalism, sabotage and arson attacks have also been used for symbolic effects, but are usually intended to be non-lethal. These types of actions can occur during political demonstrations against U.S. military presence as a provocation to host government police or U.S. security personnel to further polarize attitudes.

Protection Measures

Denying terrorists the target information they require is the most certain deterrent. Unlike deployed units, deployable units will have installation security measures, functioning local law enforcement activities, and other non-military security and investigation organizations operating in their environment. Therefore the unit operational security (OPSEC), force protection, and security programs are not the only reliable resources available to the unit planner.

Access control is one aspect of unit training that can assist in denying the terrorist target information. Because units are stationed within functioning communities, there are many interactions with non-military individuals and activities. Since there are multiple jurisdictions involved, there are various legitimate permissions to access military posts. Unit personnel should be familiar with the various types of access control documents they will encounter. If required to establish or man access control points, unit leaders should become familiar with the capabilities of common counterfeiting technologies and their effectiveness in duplicating access control and identification documents. Due to advances in digital camera and image

²⁰⁹ Bruce Hoffman, *Inside Terrorism* (New York: Columbia University Press, 1998), 125.

enhancement technology, loss or theft of documents is no longer necessary for reproduction. Likewise, electro-optical zoom lenses and hidden micro-cameras can gather keypad combinations and PIN numbers for security systems.²¹⁰ Unit planners need to understand these new vulnerabilities in order to mitigate them where possible.

Deployable forces face a variety of threats, but most are relative to their role as war fighting organizations either preparing for or moving to their missions. Their value as a terrorist target is driven by policy decisions beyond their ability to affect and may be subject to attempts to expand potential conflicts to the U.S. homeland. Therefore anticipation and alertness are the most important factors in mitigating the threat.

Leaderless Resistance

Simply put, leaderless resistance involves individuals or extremely small groups (two or three persons) who share common goals and values with a larger whole. They remain unaware of each other, and rely upon themselves to conduct actions against the enemy. While it bears similarities to network style organizations, the lack of communications links between nodes makes it more like a mob or riot phenomenon. Everyone in it seems to know what to do collectively, with little communication.

There is usually an ideological center to such groups; an individual or cabal who sets the tone for the larger mass. This center remains unaware of the radical members and their intentions. They outline an ideal condition or future to be achieved, and then exhort their followers to obtain it, without going into specifics on the method to be employed. "You know what to do" is the mission order in this environment, allowing the "leader" to avoid incitement or conspiracy charges, while claiming credit for the work of the unknown individuals or cells.

Section IV: Terrorist Threat to Institutional (Non-Deployable) Forces

This section focuses on threats as applied to U.S. forces in the non-deployable category. Non-deployable forces consist of installations, fixed infrastructure, and training establishments. It also includes National Guard and Reserve units and facilities not currently listed for deployment. Since these activities are more or less permanently fixed, discussion considers the likely threats for the United States and its' territories. Also, since these activities provide the logistic and power projection capabilities for any deployment of U.S. forces, they are likely targets of terrorist groups.

Threats discussed in this section survey attack likelihood, covering primary, potential, and possible threats. While deployable and deployed forces are particularly at risk during conflict or times of international tension, non-deployable forces will experience threats based upon domestic political tensions as well. These tensions could inspire action by a variety of social and single-issue domestic extremists from all sides of the political spectrum.

²¹⁰ Paul Kaihla, "Forging Terror," *Business 2.0* (December 2002): 3; available from <http://www.business2.com/articles/mag/0,1640,45486%7C5,00.html>; Internet; accessed 22 November 2002.

Primary Threats

The most probable threats to non-deployable forces of all kinds will likely be domestic groups with a variety of objectives. While the domestic terrorism landscape is cluttered with any number of ideological and religious motivations, most U.S. domestic terror groups have embraced the “leaderless resistance” model of organization. While this tends to limit the complexity and sophistication of these operations, it also reduces the effectiveness of infiltrating the group or developing informers, because of the decentralized nature of operations (See below).²¹¹ As the Oklahoma City bombing conclusively showed, “simple” attacks do not necessarily equal “ineffective” or “non-lethal” attacks.

One of the major threats in this category is an attack against U.S. military forces and installations to obtain weapons or equipment. In the 1970s alone, enough small arms were stolen from U.S. military facilities to outfit a force of approximately 8,000.²¹² These operations are conducted by a variety of groups, but most recently groups associated with white supremacists, various “Christian Identity” offshoots, or the “militia” movement predominate in this area. They are conducted as “inside jobs” or theft more often than actual overt raids or attacks, but the capability and inclination for violent operations is there. If the terrorist group believes the objective warrants it, assault style robberies of military equipment will occur.

Another likely threat is that transnational or state sponsored groups could target key infrastructure or support installations to reduce the military’s power projection capabilities. In fact, these type targets are on al Qaeda’s targeting list. In July 2001, Ahmed Ressam, who was trained at al Qaeda camps in Afghanistan, testified that he had been trained to blow up various types of targets, to include military installations, airports, railroads, electric plants, and gas plants. Additionally, there are reports of al Qaeda surveillance of critical infrastructure targets and an FBI Information Bulletin states that al Qaeda members have sought information on Supervisory Control and Data Acquisition (SCADA) systems, which are computer-controlled devices used to monitor and control much of our critical infrastructure.²¹³ These SCADA systems are potential targets of cyber-terrorism. (See Cyber Operations handbook for more information on cyber-terrorism.)

Although a major attack has not occurred against U.S. critical infrastructure yet, al Qaeda has a presence in the United States. This transnational presence was exhibited in 2002 when two suspected al Qaeda cells were neutralized; one in Portland, Oregon and another in Lackawanna, New York. Well-funded adversaries without a significant operational presence in the U.S., or who desire deniability, could instigate attacks utilizing various domestic groups as proxies. Money or common ideology or goals would provide the basis for this cooperation. This sort of attack would have slightly different objectives than those discussed in Section III. The destruction of critical logistics and transportation infrastructure such as rail lines,

²¹¹ Department of Justice, Federal Bureau of Investigation, Counterterrorism Threat Assessment and Warning Unit, Counterterrorism Division, *Terrorism in the United States 1999*, Report 0308, (Washington, D.C., n.d.), 18.

²¹² Christopher C. Harmon, *Terrorism Today* (London: Frank Cass Publishers, 2000; reprint, Portland: Frank Cass Publishers, 2001), 111.

²¹³ Ben Venzke and Aimee Ibrahim, *The al-Qaeda Threat: An Analytical Guide to al-Qaeda’s Tactics and Targets* (Alexandria: Tempest Publishing, LLC, 2003), 115.

pipelines, and warehouses would emphasize arson and sabotage. Unfortunately, these capabilities are highly developed in most of the domestic U.S. groups that could act as proxies for a hostile foreign entity.

In looking at threats that involve facilities and infrastructure, consideration must also be given to attacks on information systems and computer networks. Attacks directed against military systems, and designed to damage, not annoy, took place during the NATO air campaign against Serbia in 1999. Physical destruction of unprotected network components, or increasingly available technology that interrupts or damages computer circuitry from a distance may emerge as the most dangerous of these threats,²¹⁴ although malicious hacking and viruses will continue to be the most common. See Cyber Operations appendix for more information on cyber-terrorism.

Another type of target that might be selected for the sheer psychological impact is the highly symbolic target. The attack on the Pentagon in 2001 is an outstanding example of an attack with this objective. Many other posts have less famous, but still symbolically significant monuments and activities that could be subject to attacks under this scenario. In April 2004, Department of Homeland Security Secretary Tom Ridge voiced his concerns over the potential targeting of symbolic events that could be targeted by terrorists, including the dedication of the World War II memorial, Fourth of July celebrations (which often include military contingents), and the Democratic and Republican national conventions.²¹⁵

Military installations with a high concentration of military personnel and families could be attacked with some form of mass casualty weapon for the pure terror and psychological impact on the military services as a whole. Although the personal devastation this could cause would be serious enough, the resources required to counter future attacks could significantly degrade war-fighting capabilities.

Potential Threats

Conflicts over domestic social policies have a probability of causing attacks on military installations. While not participants in these policy debates, the U.S. military services have been the instruments of major social reform at the direction of both Congress and the Executive Branch. The military services have led the nation in implementation of social policies such as complete integration of racial minorities and women. Groups on both sides of contentious social issues in U.S. domestic politics watch various proposals regarding military implementation of policies regarding their particular causes. Decisions by Congress for or against military implementation of social policies on contentious domestic issues could very likely spark violence by the more radical elements of either side in these debates. The capabilities of groups involved in these issues, and the level of violence already displayed

²¹⁴ Department of Justice, Federal Bureau of Investigation, Counterterrorism Threat Assessment and Warning Unit, Counterterrorism Division, *Terrorism in the United States 1999*, Report 0308, (Washington, D.C., n.d.), 40.

²¹⁵ Adam Goldman, "Ridge Announces New Security Measures," *MyrtleBeachOnline.com*, 19 April 2004; available from http://www.myrtlebeachonline.com/mld/myrtlebeachonline/news/special_packages/riskyrx/8466467.htm; Internet; accessed 29 April 2004.

against other segments of society involved in a variety of contentious social issues make this a significant concern.

The emergence of a radicalized, ostensibly “anti-war” movement is also a distinct possibility. This sort of “anti-war” movement does not need an actual conflict to be initiated. “Anti-war” rhetoric and agendas have been incorporated into large protest gatherings such as “The Battle of Seattle” (Seattle World Trade Organization meetings in 1999) prior to the terror attacks on the U.S. and the subsequent military retaliation. The recent shifting and redefining of the traditional “radical left” ideological focus to an anti-capitalist, anti-globalization, and “economic and social justice” agenda has made any military action by U.S. forces – whether the mission is humanitarian, disaster relief, or actual combat – suspect in their eyes. Many of the left wing and single-issue organizations that espouse the anti-capitalist, anti-globalization, and anti-war rhetoric are branches or offshoots of international organizations.²¹⁶ These groups maintain ideological linkages and copy operational techniques from foreign groups. The fact that the pace of military deployments on all missions has increased, and especially with ongoing operations in Afghanistan and Iraq, is seen by many of these groups as “proof” of U.S. “imperialism.” These issues invite the targeting of U.S. military forces as the symbols and effective arms of these “imperial” policies or intended U.S. “hegemony.”

Domestic Threat To National Guard Armories

from “Terrorism in the United States, 1999” FBI Publication #0308

On December 8, 1999, Donald Beauregard, Commander and Brigadier General of the Southeastern States Alliance (SSA) was arrested on six felony counts related to his plans to steal weapons and explosives from National Guard armories in central Florida, attack power lines in several states, and ambush Federal law enforcement officers. The SSA was an “umbrella” organization composed of individuals from several militias in Florida, Georgia, South Carolina, Alabama, and other southern states. The objective of the now-defunct organization was to create social and political chaos, which members believed would cause the U.S. Government to declare martial law, thus inciting a popular uprising and violent overthrow of the Federal Government. The SSA theorized that Beauregard’s plan would create this chaos and further their goal of violent revolution. Beauregard was charged with violating several Federal laws, including Title 18 USC Section 371, conspiracy to break into a military facility to steal weapons and explosives; Title 18 USC Section 2339, providing materials in support of a terrorist organization; and four counts relating to Title 26 USC, firearms violations—transferring a sawed-off shotgun, possession of a silencer, transfer of a firearm without a serial number, and manufacture of a sawed-off shotgun.

There is also the possibility of attacks directed against military installations or personnel from single-issue terrorists focused on animal rights or environmental issues. The FBI considers these groups the largest domestic terror threat in the United States.²¹⁷ Although these groups

²¹⁶ Department of Justice, Federal Bureau of Investigation, Counterterrorism Threat Assessment and Warning Unit, Counterterrorism Division, *Terrorism in the United States 1999*, Report 0308, (Washington, D.C., n.d.), 27.

²¹⁷ Congress, House, Resources Subcommittee on Forests and Forest Health, *The Threat of Eco-Terrorism*, Statement by the FBI’s Domestic Terrorism Section Chief, James Jarboe, (Washington, D.C., 12 February 2002), 1; available from <http://www.fbi.gov/congress/congress02/jarboe021202.htm>; Internet; accessed 17 January 2003; and Robert Gehrke, “FBI: Earth Liberation Front Most Active Domestic Terror Group,” *Associated Press*

typically conduct arson, harassment, and vandalism, they have gradually increased their capabilities and rhetoric, threatening to “pick up the gun” and to target Federal offices and Federal and state law enforcement.²¹⁸ It is expected that attacks are possible on range or post construction projects that they perceive as endangering animals, animal habitat, or the earth.

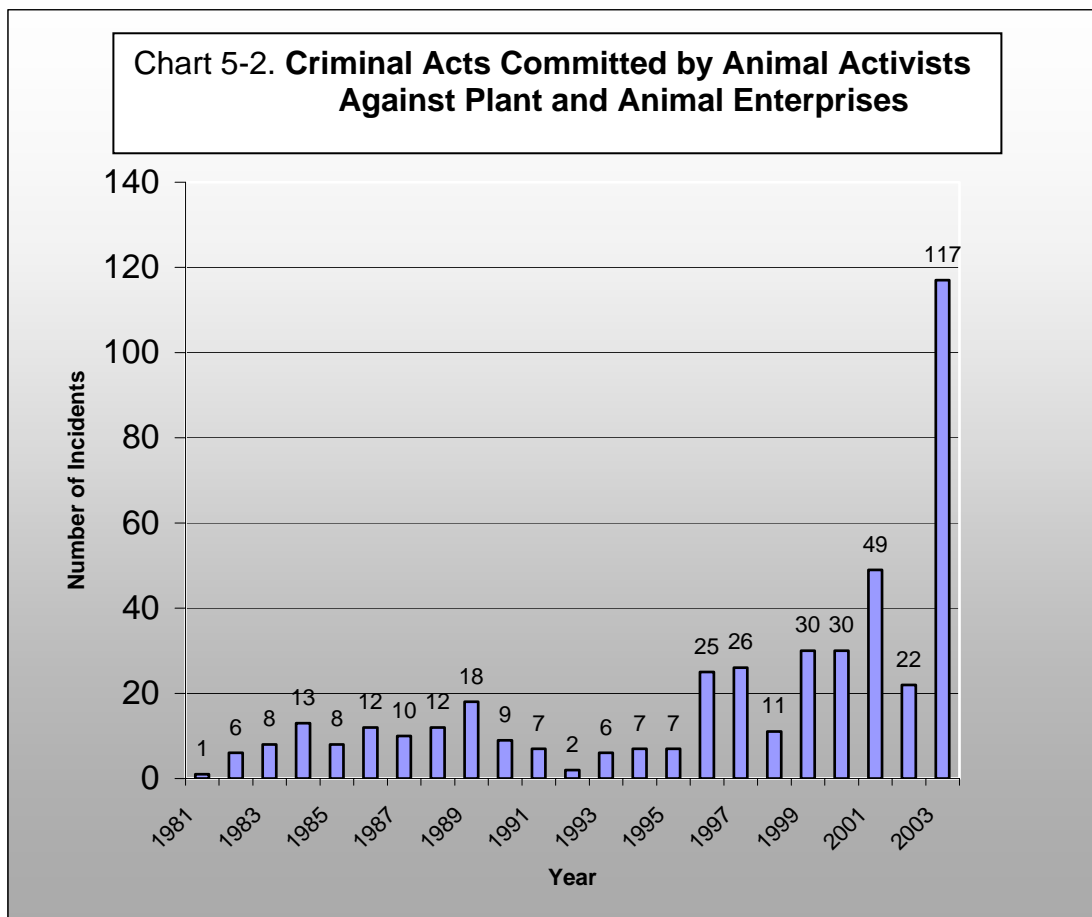

To highlight this potential threat to Federal Government representatives, following a “Revolutionary Environmentalism” conference held at California State University at Fresno in 2003, Craig Rosebraugh the past spokesman for Earth Liberation Front (ELF) issued a manifesto calling for anti-war protesters to carry out direct actions against the U.S. Government and military installations. Specifically, he called for activists to “Actively target U.S. military establishments within the United States. Again, following the above stated goal of NOT getting caught, use any means necessary to slow down the functioning of the

Newswires, 12 February 2002, 1; available from http://www.stopecoviolenace.org/pdfs/2_12_02.pdf; Internet; accessed 17 January 2003.

²¹⁸ “From Push to Shove,” *Southern Poverty Law Center Intelligence Report*, no. 107 (Fall 2002), 4; available from <http://www.splcenter.org/intelligenceproject/ip-index.html>; Internet; accessed 17 January 2003.

murdering body.”²¹⁹ Military research using animals for testing chemical or biological weapon antidotes or medical treatments could also spark direct action and harassment campaigns. Initially such attacks would be arson, vandalism and other forms of “monkey wrenching” – a term for sabotage combined with general mischief - but escalation is not only possible, it is likely. While claiming non-violence, letter-bombings and beatings have occurred in the course of these campaigns.

A 2005 assessment of U.S. domestic terrorism by the Federal Bureau of Investigation cites environmental and animal rights activists who have turned to arson and explosives as a significant threat in terms of damage and number of crimes. Analysis and comparison with groups such as right-wing extremists, anti-racial groups, and anti-abortion groups are escalating in violent rhetoric and tactics. To date, most animal rights and eco-extremists have refrained from violence targeting human life. Nonetheless, the increased number of incidents using incendiary and explosive devices is an ominous trend.²²⁰

Chart 5-2 shows the increase in criminal acts by animal activists since 1981 as reported by the Foundation for Biomedical Research. The data shows a 148% increase in incidents during the decade of the 1990s over the previous decade and the number of incidents just in the first four years of the twenty-first century equal the total for the previous two decades combined.²²¹ In 2005, the FBI noted that activists, as a general category, have claimed notoriety for 1200 crimes between 1990 and mid 2004.²²²

Possible Threats

Although not as likely as attacks or thefts to obtain military equipment, direct attacks on installations by radicalized domestic groups are possible. Objectives for such attacks are based upon the groups’ perception of the U.S. Government as illegitimate or oppressive.

Some of these extremist domestic groups desire a “golden age” perceived by them in earlier U.S. history. This often centers around either increased states’ rights or some strict, usually selective, interpretation of the U.S. Constitution. Traditionally “right-wing” groups have stepped up rhetoric and propaganda branding all government above county or state level as illegitimate. Ominously, much of the ideological material produced in this vein tends to dehumanize and advocate killing all nature of Federal Government servants, including and especially law enforcement and military personnel.

Lending credence to the possibility of these types of attacks, obvious symbols of Federal Government authority such as IRS facilities and Federal office buildings have been attacked repeatedly.²²³ Despite the inherent drawbacks to terrorist targeting of military forces discussed in Sections II and III, the chances of some sort of attack occurring are increasing. Attacks

²¹⁹ Craig Rosebraugh, “Craig Rosebraugh on the Anti-War Struggle,” *Independent Media Center of Philadelphia*, 17 March 2003; available from <http://www.phillyimc.org/article.pl?sid=03/03/17/2210240&mode=threat>; Internet; accessed 29 April 2004.

²²⁰ *FOXNews*, “Activist Extremists Top U.S. Domestic Threat,” 19 May 2005; available from http://www.foxnews.com/printer_friendly_story/0,3566.157016.00.html; Internet; accessed 19 May 2005.

²²¹ *Illegal Incidents Summary* (Washington: Foundation for Biomedical Research, 2004), 3-39; available from; <http://www.fbresearch.org/animal-activism/eventsummary.xls>; Internet; accessed 29 April 2004.

²²² *FOXNews*, “Activist Extremists Top U.S. Domestic Threat,” 19 May 2005

²²³ *Ibid.*, 52-61.

have been discovered in the planning and preparation stage. Claims that control of the U.S. military has been usurped by hostile or conspiratorial foreign “forces” encourages the targeting of military facilities and personnel.

Threats could also come from U.S. resident aliens or immigrant citizens with loyalties to ethnic, religious, or nationalist causes hostile to the U.S. or opposed to U.S. policies. As previously noted, these people may conduct operations as individuals or become operatives of existing groups. As “agents in place” – personnel already in the enemies’ territory, and therefore less likely to be detected – they could be extremely dangerous and disruptive by merely working simple attacks as individuals or small cells. Modern information and telecommunications technology permits extensive linkages between immigrants and their home countries, and in some cases acts to preserve the individual’s loyalty to the “homeland.”

National Guard facilities and personnel are potential targets of attacks or sabotage to prevent counter-drug missions in support of local law enforcement. Since a significant amount of terrorist funding is obtained by drug manufacturing and smuggling, actions to prevent these missions or reduce their effectiveness could be in the terrorists’ interests. However, these counter-drug missions would have to present a significant threat in order to provoke such attacks. Likewise, National Guard and Reserve members mobilized by their states or the Federal Government to increase security at high risk facilities in times of heightened alert may be targeted as a preemptive measure, or targeted as a statement by domestic groups against what they view as an encroaching “police state.”

Protection Measures

The heart of any program of preventive measures is denying the terrorist targeting information. Surveillance detection, OPSEC and counter intelligence activities all play a role in deterring and defeating terrorist operations. For the installation, the deployment of Military Police and other security elements is a flexible and responsive tool to react to increased threats. Coordination and liaison in accordance with legal restrictions to local and Federal law enforcement are essential. There will never be enough assets available to a post or activity to completely secure itself. Integration of existing guard posts, surveillance cameras, and other sensors into a network of coverage for the installation is a useful addition of capability to a protection plan. Similar coordination and liaison with civilian operators of critical infrastructure is just as important to ensure reliable services. The comments in Section III on access control and the ease of document counterfeiting apply to installations and activities even more than to units.

The terrorist can be affected by U.S. foreign or domestic policies, and political currents that are uncontrollable or unknown to the military members affected. Installations and activities may be targeted for symbolic reasons, in pursuit of social or political aims, in order to delay or destroy deployment capabilities, to destroy support and logistics infrastructure, to drain military resources into increased security versus war fighting, and to steal military equipment and weaponry. The potential attackers range from transnational terrorist organizations and state directed terror groups to individuals of no formal organization. Given the complex and pervasive nature of this threat, and the immense value of non-deployable forces to the military, terrorism is a challenge of tremendous proportions.

Conclusion

This chapter examined how U.S. military forces might be vulnerable to a myriad of terrorist activities. Whether military forces are deployed, deployable, or non-deployable, the potential operations conducted by terrorists are a constant threat to the military. Examples of specific terrorist operations indicate a wide range of tactics may be used to attack military units or installations. Preventive measures emphasize the importance of denying target information to the terrorist as a key to deterring and defeating terrorist operations.

This Page Intentionally Blank

Chapter 6

Future of Terrorism

All politics is a struggle for power...the ultimate kind of power is violence.
C. Wright Mills

Terrorism is evolving into a more physically dangerous and more psychologically effective weapon. While at the surface terrorism remains “The calculated use of unlawful violence or threat of unlawful violence to inculcate fear...,” it is rapidly rising from a mere tactical demonstration to become, in some incidents, a significant strategic tool of the terrorist. As terrorism emerges into a principal irregular warfare tactic and strategy of the twenty-first century, terrorists are adapting to changes in the world socio-political environment. Some of these changes facilitate the ability of terrorists to plan and operate, procure funding and other resources, and develop new capabilities. Terrorism and violence demonstrate a clear intention to gain power and influence in the future.²²⁴ This chapter will examine the probable future of terrorism and the merging of terrorists with other state and sub-state entities. Possible causes of future conflicts may assist in understanding the terrorist actors and their motivations. Finally, discussion addresses terrorism as a growing menace in the evolution of global conflict and probable considerations for U.S. military forces.

Section I: Future Trends in Terrorism

As a method of conflict witnessed from ancient era to the modern information age of the twenty-first century, terrorism adapts to meet the challenges of emerging societies and governments. Terrorism exploits developments in technology and individual or group belief systems. At least two overarching trends indicate the direction of terrorism and terrorist groups.

Terrorism is becoming a more network based that encourages a loosely organized, self-financed organizational structure. The motivation of terrorist groups appear to be based increasingly on religious belief extremes ideological absolutes. International or transnational cooperation among terrorist groups provides an improved ability to recruit members, develop fiscal support and resources, gain skills training, transfer of technology, and when desired, political advice.²²⁵

Proliferation of weapons of mass destruction and the specter of their effects clearly amplify the dangers of a terrorist act. Information is readily available on many aspects of chemical, biological, radiological, nuclear, and conventional high yield explosives. Materiel for attempting the construction of WMD is easily accessible in the public domain. The

²²⁴ Bruce Harmon, *Inside Terrorism* (New York: Columbia University Press, 1998), 183.

²²⁵ Raphael Perl, *Terrorism and national Security: Issues and Trends* (Washington, D.C.: congressional Research Service issue Brief for Congress, 22 December 2003), 1.

knowledge and technological means of specialists to produce WMD is a shadowy area of science, crime, and intrigue available to the terrorist.

***Trends
of
Future Terrorism***

- ◆ ***Intense
Motivational Extremism***
- ◆ ***Flexible
Organizational Structure***
- ◆ ***Improved
Operational Capabilities***
- ◆ ***Expanded
Transnational Associations***
- ◆ ***Increased
Weapon System Lethality***
- ◆ ***Intended
Mass Casualties - Mayhem***
- ◆ ***Exploited
Mass Media Marketing***

These trends, combined with the willingness of terrorists to use catastrophic violence and cause mass casualties and destruction, will cause a continued use of US military forces as a significant component in fighting the Global War on Terrorism. Military presence and action will remain key in the range of measures that the United States uses to combat and counter terrorism. Policy measures include diplomacy; international cooperation; domestic cooperation among Federal, state and local government; economic coordination and sanctions; protective security measures; covert actions; and military alliance, coalition, or unilateral force.

US military forces have unique skills and equipment, and used selectively as part of a larger national arsenal against terrorism, can be very effective in countering or defending against terrorist attack. US military forces will remain an integral element of US national security strategy in defending the United States and its national vital interests throughout the world.

Exploiting media coverage will remain a tool for both US military forces and the terrorist. For the terrorist, effectiveness of information operations will be measured by ability to cause a dramatic impact of fear and uncertainty in a target population. Surprise and sustained violence will be normal against specified people representing elements of civil or military control and order, or common citizens as prey for terrorists in a culture of violence. Damage or destruction of community, regional, or national infrastructure and governance will be used to gain attention, provoke excessive reaction by host nation or

coalition military forces, and attempt to alienate general population support of government policies and programs.

Terrorist groups display significant progress in emerging from a subordinate role in nation-state conflicts to become prominent as international influences in their own right. They are

becoming more integrated with other sub-state entities such as criminal organizations and legitimately chartered corporations, and are gradually assuming various levels of control and identity with national governments. For example, the FARC and ELN of Columbia depend on extortion, kidnapping, money laundering, and other economic strategies to finance their operations. Reports estimate that the FARC collects half a billion dollars per year from protecting the drug trade of the region.²²⁶ Other examples include Hizballah and HAMAS members who establish front companies and legitimate businesses to cover an illegal market system, conduct money laundering, fraud, and tax evasion. United States investigations have directly linked Hizballah and HAMAS to illegal cigarette trafficking and funneling the illicit profits to their organizations that include material support to terrorism.²²⁷

Adaptive Capabilities of Terror Groups

Terrorists have shown the ability to adapt to the techniques and methods of counter-terror agencies and intelligence organizations over the long term. The decentralization of the network form of organization is an example of this. Adopted to reduce the disruption caused by the loss of key links in a chain of command, a network organization also complicates the tasks of security forces, and reduces predictability of operations.

Terrorists have also been quick to use new electronic and cyber technologies, and adapt existing ones to their uses. The debate over privacy of computer data was largely spurred by the specter of terrorists planning and communicating over cyberspace with encrypted data beyond law enforcement's ability to intercept or decode this data. To exchange information, terrorists have exploited disposable cellular phones, over the counter long-distance calling cards, Internet cafes, and other means of anonymous communications. Embedding information in digital pictures and graphics and sending them over the Internet is another innovation employed to enable the clandestine global communication that modern terrorists require.²²⁸ See the Cyber Operations appendix for more information on terrorist use of computer technology to support their operations.

Terrorists have demonstrated significant resiliency after disruption by counter-terrorist action. Some groups have redefined themselves after being defeated or being forced into dormancy. The Shining Path of Peru (Sendero Luminosa) lost its leadership cadre and founding leader to counter-terrorism efforts by the Peruvian government in 1993.²²⁹ The immediate result was severe degradation in the operational capabilities of the group. However, the Shining Path has returned to rural operations and organization in order to reconstitute itself. Although not the threat that it was, the group remains in being, and could exploit further unrest or governmental weakness in Peru to continue its renewal.

²²⁶ Christopher C. Harmon, *Terrorism Today* (London, Portland, OR: Frank Cass, 2000), 65 and 139.

²²⁷ William Billingslea, "Illicit Cigarette Trafficking and the Funding of Terrorism," *The Police Chief*, February 2004, 49-54.

²²⁸ Thomas Homer-Dixon, "The Rise of Complex Terrorism", *Foreign Policy Magazine* (15 January 2002): 2.

²²⁹ *International Encyclopedia of Terrorism*, 1997 ed., s.v. "Terrorism in Peru."

In Italy, the Red Brigades (Brigate Rossi) gradually lapsed into inactivity due to governmental action and a changing political situation. This ultra-left wing terrorist group gained notoriety in the 1970s but had been effectively suppressed by the 1980s. In 1999, they resurfaced with the assassination of Italian government labor consultant Massimo D-Antona; in 2000, they murdered another labor consultant Marco Biagi. By late 2003, several group members had been arrested. Yet, a series of letter bombs were suspected as connected to the Red Brigade. Parcel bombs were mailed to the European Union (EU) president; bombs exploded in garbage cans near the EU president's home; letter bombs arrived at Europol, the EU's police agency; and a letter bomb arrived at the European Central Bank in Frankfurt.²³⁰

Also, a decade after the supposed demise of the Red Brigades, a new group called the Anti-Capitalist Nuclei emerged exhibiting a continuity of symbols, styles of communiqués, and potentially some personnel from the original Red Brigade organization. This ability to perpetuate ideology and symbology during a significant period of dormancy, and re-emerge under favorable conditions demonstrates the durability of terrorism as a threat to modern societies.

Expanding Capabilities

Terrorists are improving their sophistication and abilities in virtually all aspects of their operations and support. The aggressive use of modern technology for information management, communication and intelligence has increased the efficiency of these activities. Weapons technology has become more available, and the purchasing power of terrorist

“Between now and 2015 terrorist tactics will become increasingly sophisticated and designed to achieve mass casualties.”

National Intelligence Council

["Global Trends 2015: A Dialogue About the Future With Nongovernment Experts"](#) Report (Dec 2000).

organizations is on the rise. The ready availability of both technology and trained personnel to operate it for any client with sufficient cash allows the well-funded terrorist to equal or exceed the sophistication of governmental counter-measures.²³¹

Likewise, due to the increase in information outlets, and competition with increasing numbers of other messages, terrorism now requires a greatly increased amount of violence or novelty to attract the attention it requires. The tendency of major media to compete for ratings and the subsequent revenue realized from increases in their audience size and share produces pressures on terrorists to increase the impact and violence of their actions to take advantage of this sensationalism.²³²

²³⁰ Francesco Di Meglio, "Italian Terrorists Generate Fear in Europe," *Italiansrus.com*; n.d.; available from <http://www.italiansrus.com/articles/ourpaesani/redbrigade.htm>; Internet; accessed 25 February 2004.

²³¹ Fred L. Fuller, "New Order Threat Analysis: A Literature Survey," *Marine Corps Gazette* 81 (April 1997): 46-48.

²³² *International Encyclopedia of Terrorism*, 1997 ed., s.v. "The Media and International Terrorism."

An indicator of this trend is the fact that terrorist incidents have been going down in total numbers since 1991, but the lethality per incident has gone up.²³³ Chart 6-1 shows that the number of incidents began to rise in the early 1980s and peaked in 1987.²³⁴

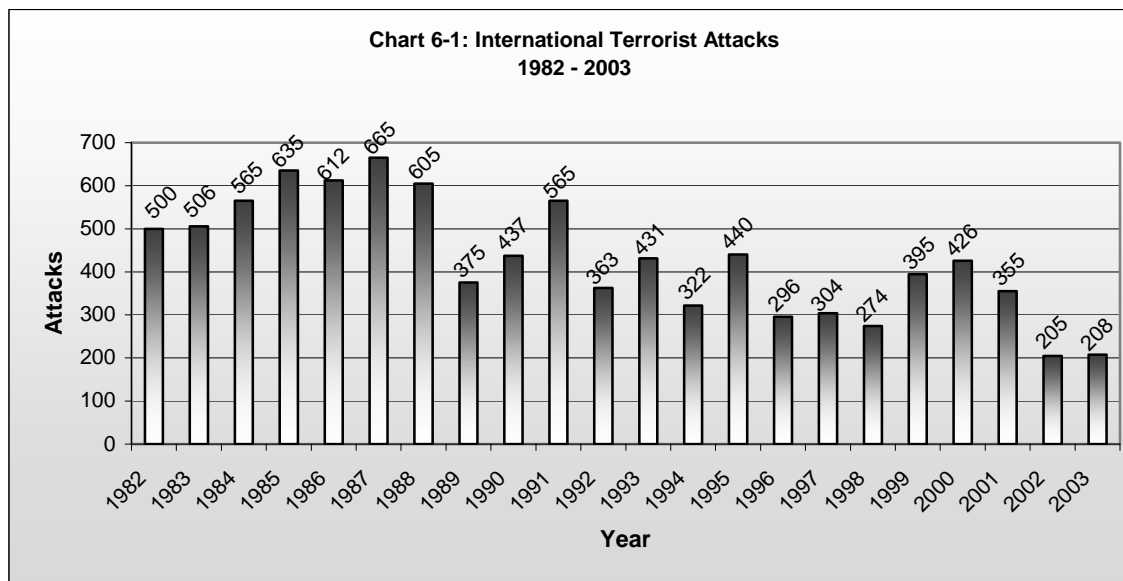

Since then the number of incidents has been declining. In fact, the years 2002 and 2003 have the fewest number of attacks during the 22-year period reflected on the chart. This is probably the result of both the war on terrorism and a conscious decision on the part of terrorist groups.

Fewer incidents with greater casualties appear to be the goal for many groups. This is not just a function of efficiency and developing skills, but also a tendency by the increasing number of religiously motivated groups to view ever-larger casualty lists as a measure of their influence and power. An ideal example of this attitude was the use of airliners as manned cruise missiles to strike the Pentagon and World Trade Center in September 2001. Chart 6-2 shows the average number of casualties per incident covering the period 1997 through 2003. As can be seen, the average number of casualties in 1997 was 3.0 per incident, whereas casualties in 2003 increased to 20.5 per incident. The years 1998 and 2001 show a large increase in the number of casualties per incident due to catastrophic events: the embassy bombings in Kenya and Tanzania in 1998 and the 9/11 incidents in 2001. These 3 events accounted for over 9000 casualties.

If the casualties from the embassy bombings of 1998, and the Pentagon and World Trade Center attacks in 2001 are removed from the data, as shown in Chart 6-3, the average casualties per incident in 2002 and 2003 indicate a significant increase in lethality over past

²³³ Bruce Hoffman, *Inside Terrorism* (New York: Columbia University Press, 1998), 200.

²³⁴ Department of State, Office of the Coordinator for Counterterrorism, *Patterns of Global Terrorism 2003* (Washington, D.C., April 2004, revised 22 June 2004), 176.

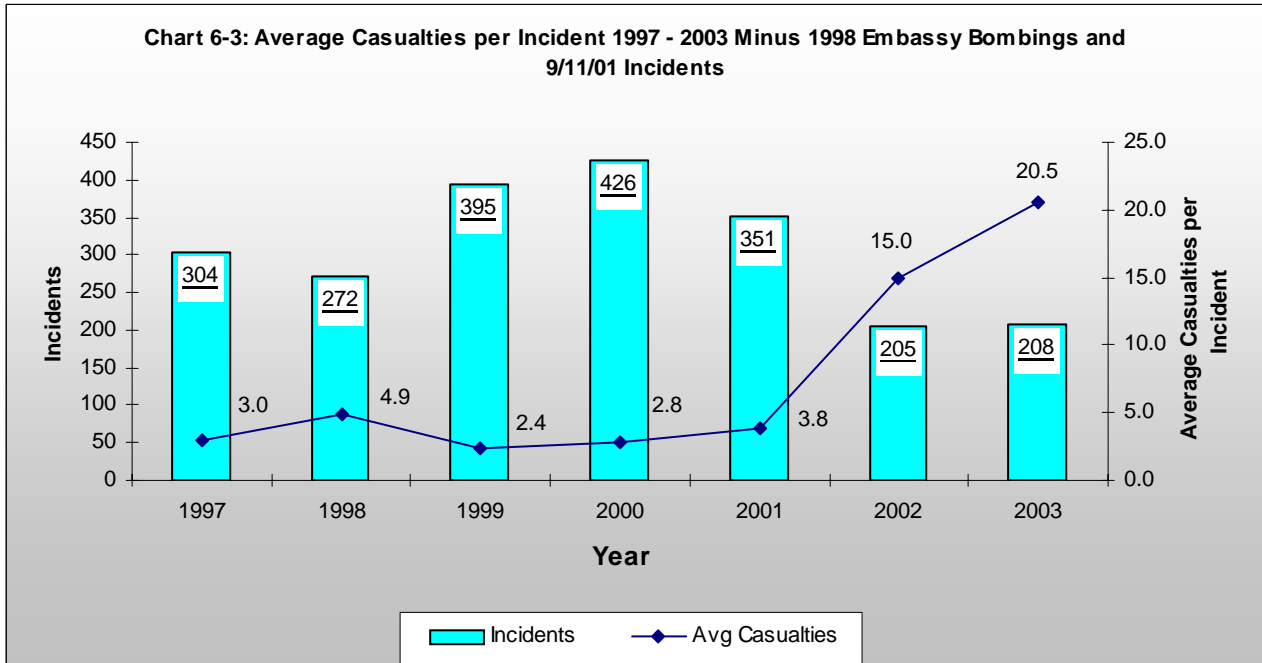
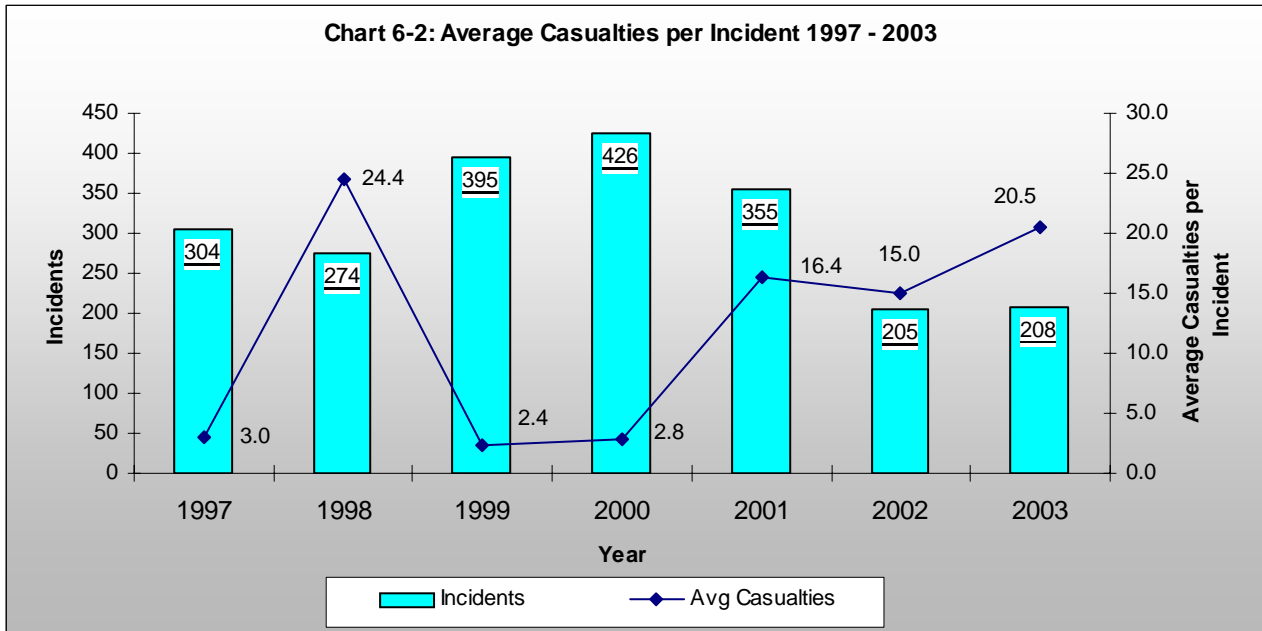

years. There were no catastrophic events during these two years, but of the 413 incidents, 55 resulted in casualties of 30 or more, and 20 of the 55 resulted in casualties that exceeded 100.²³⁵

²³⁵ Department of State, Office of the Coordinator for Counterterrorism, *Patterns of Global Terrorism 2003* (Washington, D.C., April 2004, revised 22 June 2004), 95-112; and *Patterns of Global Terrorism 2002* (Washington, D.C., April 2003), 83-98.

The trend to exploit available technologies and the desire for more casualties will probably accelerate the eventual employment of Weapons of Mass Destruction (WMD) by terrorists. Documented uses of chemical (Tokyo 1995) and biological weapons (Oregon in 1984²³⁶ and Florida and Washington D.C. in 2001) demonstrate the ability to use WMD. Al Qaeda has stated an intention to acquire and attack the United States with WMD.

Escaping Dependence

During the evolution of modern terrorism in the Cold War era, even nationalist insurgent groups sought and required a sponsor from one of the two competing ideological blocs. Sponsors could effectively influence the policy of their clients, and exercise a limited form of control over their actions. This gradually shifted to a less rigid control as more sponsors, such as Libya, entered the field. The collapse of the Soviet Union removed the motivations and capabilities of a large number of state sponsors. This loss of significant resources eliminated support for many terrorist groups, particularly those terrorist groups closely aligned with the communist bloc.²³⁷

Punitive actions against rogue states have gradually reduced or denied some geographical sanctuaries and sources of support for terrorists. Although this can be temporarily disruptive, new support structures can replace previous systems. Groups based in Libya shifted to Iraq or Syria when support was restricted due to international sanctions and U.S. military action against Libya because of their sponsorship of terrorism. Similarly, al Qaeda shifted key functions from the Sudan to Afghanistan when U.S. action and diplomatic pressure were brought to bear in that geographical area.

In response, terrorists have adjusted their financial operations to become more self-sustaining in their activities, resulting in greater independence from any external control. Terrorist operations require extensive financial support. The facility with which groups can obtain and move funds, procure secure bases, and obtain and transport weaponry determines their operational abilities and the level of threat that they pose. The international nature of finance, the integration of global economies, and the presence of terrorists in the illegal “black” economies of slaves, drugs, smuggling, counterfeiting, identity theft, and fraud have aided this new independence from traditional sources of sponsorship and support.²³⁸

This evolutionary development has inverted the previous relationship between terrorists and governments.²³⁹ In the earlier relationships, the nation-state sponsor had some measure of control. Due to the ability of terrorist groups to generate tremendous income from legitimate and illegal sources, it often becomes the terrorist organization that “sponsors” and props up its weaker partner, the national government. For example, during the period it was based in Afghanistan, al Qaeda was running an annual operating budget of approximately \$200

²³⁶ Bruce Hoffman, *Inside Terrorism* (New York: Columbia University Press, 1998), 121.

²³⁷ Christopher C. Harmon, *Terrorism Today* (London: Frank Cass Publishers, 2000; reprint, Portland: Frank Cass Publishers, 2001), 3.

²³⁸ Kimberly L. Thachuck, “Terrorism’s Financial Lifeline: Can it Be Severed,” *Strategic Forum* no. 191 (May 2002): 2.

²³⁹ Maurice R. Greenberg, Chair, William F. Wechsler and Lee S. Wolosky, Project Co-Directors, *Terrorist Financing: Report of an Independent Task Force Sponsored by the Council on Foreign Relations* (New York: Publication Office, Council on Foreign Relations, 25 November 2002), 5.

million, while their hosts, the Taliban had only \$70 million annually.²⁴⁰ In addition to financial supremacy, al Qaeda personnel also provided much of the technical expertise the Taliban lacked. The only asset the Taliban had to offer was sanctuary and the advantages their status as a recognized national government provided in some countries.

Although the explosion in terrorist income has been tied to the increasing involvement of terrorists in international crime, simpler support by the more traditional means of donations,

“States with poor governance; ethnic, cultural, or religious tensions; weak economies; and porous borders will be prime breeding grounds for terrorism. In such states, domestic groups will challenge the entrenched government, and transnational networks seeking safe havens.”

"Global Trends 2015: A Dialogue About the Future With Nongovernment Experts" Report (December 2000).

extortions, and extra-legal contributions can be leveraged into significant sums through investment. The PLO is an excellent example of financing through legitimate investments. The organization managed to acquire sufficient wealth by these means in the 1980s, receiving an estimated 80% plus of its annual operating budget of \$600 million from investments.²⁴¹ This allowed the PLO progressively greater autonomy in dealing with other nations.

Merging Identities

Terrorist groups and other illegal sub-state organizations are rapidly becoming indistinguishable from each other. The increasing role of criminal activity in financing terrorism, either in partnership or competition with traditional criminal activities, is making it very difficult, if not impossible, to clearly determine where one stops and the other begins. These enterprises include well-publicized activities such as drug trafficking and smuggling, which some terrorists, insurgencies, and even less reputable governments have been engaged in for decades. They also include newer, less well-known illegal activities such as welfare fraud, tax evasion and fraud, counterfeiting, and money laundering. Many of these activities are offshoots of terrorist groups' evolving capabilities of false documentation and concealment of money transactions for their operational purposes. These activities now generate a profit for additional funding.

Terrorists and criminal organizations are becoming more closely related, as terrorists utilize criminal networks and methods to operate, and as criminals become more politicized.²⁴² As

²⁴⁰ David Albright, "Al Qaeda's Nuclear Program: Through the Window of Seized Documents," *Policy Forum Online Special Forum* 47 (6 November 2002): 8; available from http://www.nautilus.org/fora/Special-Policy-Forum/47_Albright.html; Internet; accessed 14 February 2003.

²⁴¹ Bruce Hoffman, *Inside Terrorism* (New York: Columbia University Press, 1998), 84.

²⁴² "The New Threat of Organized Crime and Terrorism" *Jane's Terrorism & Security Monitor* (6 June 2000): 1-5; available from http://www.janes.com/security/international_security/news/jtsm/jtsm000619_1_n.shtml; Internet; accessed 27 June 2000.

national governments fail, their ruling elites frequently criminalize the nation itself, lending their sovereignty to smuggling, money laundering, piracy, or other illicit activities. Their security forces may retreat into terrorism to hold onto what power or authority they can, and use terrorist groups to function in place of the official arms of the government. Successful coups often generate governments that immediately resort to terror to consolidate their position.²⁴³

This interpenetration of a criminal element into the government while government officials are “seeping” down to the terrorists’ level is the result of governments feeling that legality, in the international sense, is a luxury they cannot afford, and perhaps do not need. They lack the resources to adhere to “legalistic” notions, and thus sink into criminality. The better-funded sub-state organizations (terrorist, criminal, etc.) infiltrate or supplant the government. Eventually, there is no distinction between the two as they effectively merge. The situation in Liberia at the start of the twenty-first century is an excellent example of this phenomenon.

A development related to this is the emergence of “gray areas” where no government exercises actual control. Control is imposed by sub-state actors that can span criminal organizations, militias, and terrorists. These groups may as coalitions or in various states of coexistence ranging from truce to open hostility. These areas may be located in urban centers or rural regions and a lack or absence of any effective government control.²⁴⁴

Section II: The Future of Conflict

Whether you view the post-Cold War world with alarm or optimism, it is clear that there will be future conflicts. There are more unresolved international issues left over from the forty-plus years of the Cold War than from the conclusion of either of the two World Wars. However, now there is no “balance of power” or two-power system to regulate the conflicts that will arise from these issues. Finally, the types of issues, and the antagonists involved with them, have fundamentally shifted. The nation-state system is showing signs of erosion in many parts of the globe, and a return to the days of mercenary chieftains and small city-states is already underway in some areas of the world.

In this section we will look at what will inspire conflicts in the twenty-first century, and what some of the differences from the existing pattern will be. We will then look at some of the resulting practical impacts on the use of terrorism against U.S. forces.

Disruptive Conditions

The world order has changed significantly in recent decades. The number of new, sovereign nations that emerged from the end of the Cold War rivals the new nations created after the two World Wars and the retreat of the colonial empires in the 1950s and 1960s. However, not all of these nations are viable states and most of them do not have stable leadership other than that of local ethnic or tribal strongmen. Many have significant problems aside from poor leadership. The most significant of these problems include disease, resource depletion, factionalism, and incursions from neighboring states.

²⁴³ Robert Kaplan, *The Coming Anarchy: Shattering the Dreams of the Post Cold War* (New York: Random House, 2000), 48.

²⁴⁴ Xavier Raufer, “New World Disorder, New Terrorisms: New Threats for the Western World,” in *The Future of Terrorism*, ed. Max. Taylor and John Horgan (Portland: Frank Cass Publishers, 2000), 32.

The incidence of newer pandemics such as HIV/AIDS are just now beginning to equal the lethality of older scourges such as plague, malaria and other tropical fevers. The World Health Organization reports 1,000 to 3,000 cases of plague every year.²⁴⁵ On the other hand, the 2004 United Nations report on AIDS reports almost five million new cases of HIV in 2003.²⁴⁶ of Gene research and the field of genomics may help combat new diseases, but offer the potential of a two-edged sword. Although it may provide advances in health care, it could also acquire a perverse tack toward biological warfare with very specific infections and target groups.²⁴⁷

Countries may lack a base of sufficient industrial or technological production to sustain an economic system and attempt to rely on basic agriculture and resource extraction. Often, population pressure and lack of foresight encourage rapid depletion of finite resources. The establishment of a viable economic system to support a national government becomes impractical and what little economic activity is possible is usually conducted illegally.

Many nations are simply geographic fictions. They are results of an earlier international power strategy on a map and lack any sense of national or geographic identity. Tensions between tribal or ethnic factions, or a minority in one nation aligning with similar groups of a regional nation other than their own nation can be destabilizing.

In a related development non-state and sub-state organizations and power blocs are assuming military roles and utilizing organized forces in conflicts, and terror tactics in social or political conflicts. Major corporations, private security companies, and well-funded transnational terror groups have all played significant roles in failed or dysfunctional states

Two likely models regarding the fundamental nature of future conflicts, and while they are not mutually exclusive, emphasize struggle among cultures or a disintegration of a culture. The first model is strategic in nature, and reflects that past conflicts have moved from tribal to national to ideological struggles, culminating with World War II and the Cold War. This view predicts fighting along the parts of the world where cultures intersect, such as the Central Asian confluence of the Islamic and Eastern Orthodox cultures. The assumption is future conflicts will be between cultures, and wherever there is a line of engagement between two differing cultures, there will be conflict..²⁴⁸

A transnational network like al Qaeda becomes more than a fundamentalist religious terror movement in such a setting. A goal of replacing the power structures in the historical Arab world with a new Caliphate is impractical and unlikely, but when viewed at a clash of cultures, al Qaeda becomes a true transnational insurgency. The struggle fights against

²⁴⁵ "Plague," *CDC Plague Home Page*; available from <http://www.cdc.gov/ncidod/dvbid/plague/index.htm>; Internet; accessed 9 July 2004.

²⁴⁶ *2004 Report on the Global AIDS Epidemic: Executive Summary* (Geneva: Joint United Nations Programme on HIV/AIDS, 2004), 5.

²⁴⁷ "In My Humble Opinion: Genomics is the most important economic, political, and ethical issue facing mankind," *Fast Company*, November 1999; available from <http://www.fastcompany.com/online/29/jellis.html>; Internet; accessed 26 February 2004.

²⁴⁸ Samuel Huntington, "The Clash of Civilizations," *Foreign Affairs* (Summer 1993): 2; available from http://www.lander.edu/atannenbaum/Tannenbaum%20courses%20folder/POLS%20103%20World%20Politics/103_huntington_clash_of_civilizations_full_text.htm#I.%20THE%20NEXT%20PATTERN%20OF%20CONFLICT; Internet; accessed 6 December 2002.

imposed Western political ideals and alien social order across multiple countries and regions simultaneously. Stateless for the moment, these cadres hope to organize the vanguard of an extremist religious revolution whose eventual success they consider inevitable.

The second model predicts the failure of numerous current nation-states in the developing regions of the world. Unable to exert authority, protect their citizens, or control their borders, they are disintegrating. Many of these countries are splintering into tribal and ethnic factions that might coalesce into a new, more stable form, or continue to devolve through violence into lawless zones of minor warlords and bandits.²⁴⁹

Regardless of which model more accurately describes the future, a most important occurrence common to both will be the merging of terrorists as they adapt and improvise flexible national, international, or transnational organizations.

How Changes Impact Terrorism and US Forces

Terrorism has generally seen success as a tactic and failure as a strategy. Many of the emerging entities that are rising to wield effective power in failing states are only concerned with the immediate tactical effects of their actions. They therefore look upon modern terrorism as an effective mode of conflict. They can point to the fact that al Qaeda invested \$500,000 in an attack that is estimated to eventually cost the U.S. Government \$135 billion in damages and recovery costs.²⁵⁰ Considering that these figures do not reflect the costs of military and law enforcement efforts to investigate and destroy the organization responsible, the comparative return on the investment is even greater.²⁵¹

Nonetheless, terrorism can have strategic impacts far beyond the physical damage of a terrorist attack. The terrorist bombings of commuter trains in Madrid just prior to a national election may indicate an alarming result on national resolve. A democratic election and political process appeared to react to these terrorist attacks, and caused a change in a sovereign government. National policies and coalition support to the Global War on Terrorism changed dramatically with this new government.

Emerging and sub-state entities are not compelled to obey any established rules regarding the uses of force. Terrorism and the use of terror to oppress may be viewed as logical and effective methods to accomplish objectives. The development of rules of war and the framework of international laws that attempt to protect the civilian from military action are irrelevant to these combatants. Thus the expansion of where and to whom violence may be applied will accelerate. The treatment of prisoners will rely more on the provision for ransom or retribution for mistreatment than on the rulings of the international agreements such as Geneva Convention.²⁵²

²⁴⁹ Robert Kaplan, *The Coming Anarchy: Shattering the Dreams of the Post Cold War* (New York: Random House, 2000), 7-9.

²⁵⁰ Kimberly L. Thachuck, "Terrorism's Financial Lifeline: Can it Be Severed," *Strategic Forum* no. 191 (May 2002): 4.

²⁵¹ Fred L. Fuller, "New Order Threat Analysis: A Literature Survey", *Marine Corps Gazette* 81 (April 1997): 46-48.

²⁵² Martin L. Van Creveld, *The Transformation of War* (New York: The Free Press, 1991), 202.

The unit leader and planner mind set must be prepared to operate in a chaotic and unstructured contemporary operational environment. This mind set includes the sobering concept that their units may likely be the only order or structure in their area of operations. There may be no host nation government and perhaps no local government. Several groups may claim to be the legitimate authority with the potential for some or all of the groups to be hostile.²⁵³ U.S. forces deployed in these environments will constitute mobile capsules of order and structure, but that order will disappear after they pass through the area.

There are theories for using all of these levels of disorder, as well as economic warfare, information warfare, and conventional military force, in an orchestrated campaign against an adversary. This would be conducted as a long-term effort of undeclared conflict that might appear as amicable relations between the two adversaries, but with one pursuing the eventual defeat of the other through multiple, simultaneous methods.²⁵⁴ Forms of terrorism easily fit into this construct of overt and covert conflict. The arena of cyber-war exemplifies the ability to impact on critical infrastructure, and its disruption and damage to national security, economic functions, and U.S. military response.²⁵⁵

The effectiveness of this approach is in the costs to the victim to defend against multiple threats with no clear foe. Operational control over the various tools employed by the aggressor is not required, as long as the tools perform their role of reducing the adversary of resources and resolve. Deniability is maintained and diplomacy pursued to keep the conflict from becoming focused before the aggressor is ready. Although all manner of unconventional threats may be employed, terrorism is a key component of this strategy.

On the practical level, what changes to terrorist operations will concern U.S. forces? Terrorism will continue to increase in lethality. Who is the terrorist? Terrorism is merging and combining with various other state and sub-state actors, further blurring the difference between criminals, rogue governments, and terrorists. These are concerns regarding the impacts and interactions of mass media, technological advances, urbanization, and illegal fundraising with terrorism.

There is an increasingly technological and informational nature to all conflict. Terrorism is no exception. Terrorists will continue to cultivate the ability to use new and innovative technologies, and methods of applying existing technologies to new uses. Terrorists will go exclusively “high-tech,” but they will explore the increase in capabilities that technology provides, especially the synergy between simple operations and selective technologies to ensure success.

Terrorists will attempt to exploit US vulnerabilities to information dominance. Casualty avoidance and the media effect are interrelated perceptions held by many potential adversaries of the US social and political situation. Terrorists may believe the US. is extremely casualty

²⁵³ Robert Kaplan, *The Coming Anarchy: Shattering the Dreams of the Post Cold War* (New York: Random House, 2000), 47.

²⁵⁴ Qiao Liang and Wang Xiangsui, *Unrestricted Warfare*, trans. Department of State, American Embassy Beijing Staff Translators (Washington, D.C., 1999).

²⁵⁵ President, *The National Strategy to Secure Cyberspace*. (Washington, D.C., February 2003), Preface; available from http://www.whitehouse.gov/pcipb/cyberspace_strategy.pdf; Internet; accessed 8 December 2003.

averse and that images and news of casualties will be easy to deliver to the American public in their living rooms. While this effect may be overemphasized, promotion of goals, acts, and demands are significant part of terrorist operations.

In the techniques of media coverage, terrorists were pioneers.²⁵⁶ Since the terrorists prepare their operations around the desired media effect, they will be prepared and vocal or visual for reporting coverage. They will orchestrate supporting events and interviews to reinforce the desired message. Terrorists have well-established methods of presenting disinformation and false perspectives. Frequently, military reluctance to comment on ongoing operations in the media for operational security (OPSEC) reasons can assist the terrorist. If no balanced information comes from official sources in a timely manner, the media will use the information readily available from the terrorist as a primary source for reporting the story.

Terrorists will exploit the vulnerabilities of new technologies to attacks or disruption. Terrorists have a great deal of flexibility in their ability to acquire new technology. They also have the advantage of only needing to attack or neutralize specific systems or capabilities. Consequently, they can narrowly focus their expenditures on the limited counter-technology they need. Also, they can neutralize some advanced systems or capabilities through the use of innovative and unconventional techniques, such as the employment of suicide bombers.

Modern, high-technology societies are susceptible to a “complex terrorism.” Dependence on electronic networks, sometimes with minimal redundancy, and concentrating critical assets in small geographic locales can present lucrative targets for the terrorist. Ensuring redundant systems exist, dispersing critical assets physically, and creating buffers, firewalls, or other type safeguards can enhance defense and recovery from such complex terrorist attacks.²⁵⁷

There are potential cyber-terrorism impacts here in relation to the U.S. military transformation. As the U.S. military increases its battlefield information capabilities, vulnerabilities peculiar to networks such as overload feedback between nodes and destruction of key concentration nodes become available for terrorists to exploit.²⁵⁸ Deception techniques exploiting our reliance on technology have already been used with some success.²⁵⁹ When Usama bin Laden thought American satellites were being used to locate him tracing his satellite phone, he had an aid depart from his location carrying the phone. Evidently the aid was captured with the phone, while bin Laden escaped.

The military will not be the only, or necessarily the primary target of new strategies useful against leading edge technologies and organizations. The dispersal of key civilian infrastructure nodes into locations remote from the urban complexes they serve increases their vulnerability and the reliance on computerized control systems to monitor and control these nodes increase their exposure to cyber-terrorism.

²⁵⁶ Bruce Hoffman, *Inside Terrorism* (New York: Columbia University Press, 1998), 133-139.

²⁵⁷ Thomas Homer-Dixon, “The Rise of Complex Terrorism,” *Foreign Policy Magazine* (January-February 2002): 1, 6, and 7; available from http://www.foreignpolicy.com/story/cms.php?story_id=170; Internet; accessed 26 August 2004.

²⁵⁸ *Ibid.*, 3-4.

²⁵⁹ “Osama’s Satellite Phone Switcheroo,” *CBS News.com*, 21 January 2003, 1; available from <http://www.cbsnews.com/stories/2003/01/21/attack/main537258.shtml>; Internet; accessed 10 February 2003.

Participation in and use of terrorism will increase. Individuals and groups that are not currently employing terrorism will adopt it as a tactic, and those that are employing terror tactics at low levels of lethality will become more violent. This is a combination of existing terrorist groups trying to destabilize the existing order on an ever-widening basis, and the previously discussed tendency of terrorist groups to increase the level of violence when not immediately successful.²⁶⁰

Terrorist basing and operations in urban environments will increase. Terrorists have typically operated in urban environments, but the emergence of “megalopolis” cities in undeveloped or poorly developed countries, with poor services, weak governance, and rampant unemployment and dissatisfaction has created a near perfect recruiting ground-cum-operating environment for terrorists. Many of these cities have adequate international communication and transport capacities for the terrorists’ purposes; yet have ineffective law enforcement and a potentially huge base of sympathizers and recruits. The inability of external counter-terror and law enforcement organizations to effectively intervene where the local government is unable to assert authority is another advantage.²⁶¹

The advantage to terrorist organizations that use criminal activities to fund operations will continue to grow. Money is the great force multiplier for terrorists, and criminal activity produces more money than other strategies. The annual profit from criminal activity is estimated at 2-5% of the world Gross Domestic Product, or \$600 billion to \$1.5 trillion *in profit*.²⁶² Terrorists are emphasizing criminal activities for their support funding because it allows them to compete more effectively with their adversaries, and conduct larger and more lethal operations.

Conclusion

This chapter examined the future of terrorism with emphasis on the integration of terrorism with concepts of world disorder and new forms of conflict. The evolution of some terrorist activity into non-state, politicized criminal action is a conflict arena of growing concern. The merging of criminals, rogue political leaders, and terrorists into various groupings for their mutual benefit may be temporary as a collective identity, or may build some longevity as substantial bases of fiscal and materiel support and safehaven. International or transnational links and associations further complicate the countering of terrorism.

²⁶⁰ Bruce Hoffman, *Inside Terrorism* (New York: Columbia University Press, 1998), 162-163.

²⁶¹ Xavier Raufer, “New World Disorder, New Terrorisms: New Threats for the Western World,” in *The Future of Terrorism*, ed. Max Taylor and John Horgan (Portland: Frank Cass Publishers, 2000), 32.

²⁶² Kimberly L. Thachuck, “Terrorism’s Financial Lifeline: Can it Be Severed,” *Strategic Forum* no. 191 (May 2002): 2.

Appendix A

Terrorist Threat to Combatant Commands

U.S. interests are spread throughout the world. So, every Muslim should carry out his real role to champion his Islamic nation and religion. Carrying out terrorism against the oppressors is one of the tenets of our religion and Shari'ah.

Al Qaeda Statement, October 10, 2001

General

In 2002, the Secretary of Defense and Chairman of the Joint Chiefs of Staff announced the 2002 Unified Command Plan, which established five Combatant Commands:

- U.S. Northern Command (USNORTHCOM)
- U.S. Southern Command (USSOUTHCOM)
- U.S. Pacific Command (USPACOM)
- U.S. European Command (USEUCOM)
- U.S. Central Command (USCENTCOM)



Figure A-1. The World with Commanders' Areas of Responsibility

²⁶³ Department of Defense, *Special Briefing on the Unified Command Plan*, by Donald H. Rumsfeld, (Department of Defense News Briefing Transcript presented at the Pentagon, Wednesday, 17 April 2002 – 11:30a.m.); available from http://www.defenselink.mil/news/Apr2002/t04172002_t0417sd.html; Internet; accessed 18 November 2002.

This appendix addresses the terrorist threat facing each one of these commands. Each Combatant Command Area of Responsibility (AOR) is listed reflecting the terrorist groups that are physically based within it, plus other groups that either have a presence or have operated within the AOR. We must realize, though, that any terrorist group that has the manpower and financial resources can operate within an AOR if its objectives dictate an operational requirement to do so. Imminent danger to U.S. military forces can change rapidly. Not all groups listed will profess to target U.S. interests, but all listed could easily do so.

This material should be considered suitable for general orientation. Since the information on terrorist groups is dynamic and changes frequently, actual planning and threat assessments should utilize appropriate intelligence products from the commands listed. The major input for this section comes from the United States Department of State report entitled: “Country Reports on Terrorism 2004”, dated April 2005²⁶⁴ (located at <http://www.state.gov/s/ct/rls/c14813.htm>), and the National Counterterrorism Center report “A Chronology of Significant International Terrorism for 2004”, dated April 2005²⁶⁵ (located at http://www.tkb.org/documents/Downloads/NCTC_Reports.pdf). Information listed for USNORTHCOM was also obtained from the FBI publication, *Terrorism in the United States*²⁶⁶ (located at <http://www.sas.org/Terrorist/archive/FBIterror99.pdf>) and the *Historical Dictionary of Terrorism*.²⁶⁷ An * indicates past history of anti-U.S. activity.

U.S. Northern Command

<i>Groups Physically Based In AOR</i>	<i>Strength</i>	<i>Anti-U.S. Activity</i>
<i>Animal Liberation Front (ALF)*</i>	Unknown	Yes
<i>Aryan Nations*</i>	150 – 500	Yes
<i>Christian Identity affiliated groups*</i>	Varies	Yes
<i>Earth Liberation Front (ELF)*</i>	Unknown	Yes
<i>Fuerzas Armadas de Liberacion Nacional Puertorriquena (Armed Forces for Puerto Rican National Liberation (FALN))*</i>	< 50	Yes
<i>Jamaat ul-Fuqra*</i>	200	Yes

²⁶⁴ Department of State, Office of the Coordinator for Counterterrorism, *Country Reports on Terrorism 2004*, (Washington, D.C., April 2005), 92-129.

²⁶⁵ National Counterterrorism Center, *A Chronology of Significant International Terrorism for 2004*, (Washington, D.C., April 2005), 3-87.

²⁶⁶ Department of Justice, Federal Bureau of Investigation, Counterterrorism Threat Assessment and Warning Unit, Counterterrorism Division, *Terrorism in the United States 1999*, Report 0308, (Washington, D.C., n.d.), 50-51.

²⁶⁷ Sean K. Anderson & Stephen Sloan, *Historical Dictionary of Terrorism* (Lanham, MD: Scarecrow Press, Inc, 2002).

<i>Ku Klux Klan affiliated groups*</i>	9,000 – 20,000	Yes
<i>Loosely affiliated ad hoc groups*</i>	Varies	Yes
<i>Los Macheteros (Puerto Rico)*</i>	< 40	Yes
<i>Militias/Patriot/Conspiracy affiliated groups*</i>	Varies	Yes
<i>Neo-Nazi affiliated groups*</i>	Varies	Yes
<i>Posse Comitatus groups*</i>	1,000 – 3,000	Yes
<i>Skinhead affiliated groups*</i>	2,500 – 3,500	Yes
<i>World Church of the Creator (WCOTC)*</i>	Unknown	Yes

Table A-1. Terrorist Groups Based in USNORTHCOM

<i>Other Groups Operating or with Presence in the AOR</i>	
<i>Al-Gama'a al-Islamiyya (IG)*</i>	<i>Japanese Red Army (JRA)*</i>
<i>Al Qaeda*</i>	<i>Kach</i>
<i>Cambodian Freedom Fighters (CFF)</i>	<i>Kahane Chai</i>
<i>HAMAS</i>	<i>Manuel Rodriguez Patriotic Front (FPMR)*</i>
<i>Hizballah*</i>	<i>Mujahedin-e Khalq Organization (MEK)*</i>

Table A-2. Terrorist Groups with Presence in USNORTHCOM

U.S. Southern Command

<i>Groups Physically Based In AOR</i>	<i>Strength</i>	<i>Anti-U.S. Activity</i>
<i>Manuel Rodriguez Patriotic Front (FPMR), (Chile)* (Listed in the 2003 State Department Report-Deleted in 2004)</i>	50 - 100	Yes
<i>Morzanist Patriotic Front (FPM), (Honduras)* (Listed in the 2003 State Department Report-Deleted in 2004)</i>	Unknown (Est. small)	Yes

<i>National Liberation Army (ELN), (Colombia)*</i>	3,000 combatants	Yes
<i>Revolutionary Armed Forces of Colombia (FARC), (Colombia)*</i>	9,000 – 12,000	Yes
<i>Sendero Luminoso (Shining Path) (SL), (Peru)*</i>	300	Yes
<i>Tupac Amaru Revolutionary Movement (MRTA), (Peru)</i>	≤100	None
<i>United Self-Defense Forces/Group of Colombia (Autodefensas Unidas de Colombia) (AUC), (Colombia)</i>	8,000 – 11,000	None

Table A-3. Terrorist Groups Based in USSOUTHCOM

<i>Other Groups Operating or with Presence in the AOR</i>	
<i>Al-Gama'a al-Islamiyya (IG)*</i>	<i>Irish Republican Army (IRA)</i>
<i>Al Qaeda*</i>	<i>Mujahedin-e Khalq Organization (MEK)*</i>
<i>Hizballah*</i>	

Table A-4. Terrorist Groups with Presence in USSOUTHCOM

U.S. European Command

<i>Groups Physically Based In AOR</i>	<i>Strength</i>	<i>Anti-U.S. Activity</i>
<i>Al-Aqsa Martyrs Brigade,(al-Aqsa), (Occupied Territories)*</i>	Unknown	Yes
<i>Anti-Imperialist Territorial Nuclei (NTA), a.k.a.: Anti-Imperialist Territorial Units, (Italy)*</i>	20	Yes
<i>Armed Islamic Group (GIA), (Algeria)</i>	Unknown (Est. < 100)	None
<i>Army for the Liberation of Rwanda (ALIR), a.k.a.: Interahamwe, Former Armed Forces of Rwanda (ex-FAR), (Rwanda)*</i>	Unknown (Several thousand operate in eastern DRC)	Yes
<i>'Asbat al-Ansar (The League of the Followers), (Lebanon)*</i>	300	Yes
<i>Basque Fatherland and Liberty (ETA), a.k.a.: Euzkadi Ta Askatasuna, (Spain)</i>	Unknown (Est. several hundred)	None

<i>Continuity Irish Republican Army (CIRA), a.k.a.: Continuity Army Council, (Northern Ireland)</i>	< 50	None
<i>Democratic Front for the Liberation of Palestine (DFLP), (Occupied Territories) (Listed in the 2003 State Department Report-Deleted in 2004)</i>	500	None
<i>First of October Antifascist Resistance Group (Grupo de Resistencia Anti-Fascista Primero de Octubre) (GRAPO), (Spain)*</i>	Unknown (Est. < 24)	Yes
<i>Great East Islamic Raiders – Front (IBDA-C), (Turkey)</i>	Unknown	None
<i>HAMAS (Islamic Resistance Movement), (Occupied Territories)</i>	Unknown combatants <10,000 Supporters	None
<i>Hizballah (Party of God), a.k.a.: Islamic Jihad, Revolutionary Justice Organization, Organization of the Oppressed on Earth, Islamic Jihad for the Liberation of Palestine, (Lebanon)*</i>	Several hundred Several thousand supporters	Yes
<i>Irish National Liberation Army (INLA), (Northern Ireland)</i>	< 50	None
<i>Irish Republican Army (IRA), a.k.a.: Provisional Irish Republican Army (PIRA), the Provos, (Northern Ireland)</i>	Several hundred	None
<i>Islamic International Peacekeeping Brigade (IIPB), Chechnya</i>	400	None
<i>Japanese Red Army (JRA), a.k.a.: Anti-Imperialist International Brigade (AIIB), (Lebanon) *</i>	6	Yes
<i>Kahane Chai (Kach), (Israel)</i>	Unknown	None
<i>Kongra-Gel (KGK), a.k.a.: Kurdistan Workers’ Party (PKK), a.k.a.: Kurdistan Freedom and Democracy Congress (KADEK), Freedom and Democracy Congress of Kurdistan, (Turkey)</i>	4,000 – 5,000	None
<i>Libyan Islamic Fighting Group, a.k.a.: Al-Jam’ a al-Islamiyyah al-Muqatilah, Fighting Islamic Group, Libyan Fighting Group, Libyan Islamic Group, (Libya)</i>	Unknown (Est. several hundred)	None
<i>Lord’s Resistance Army (LRA), (Uganda)</i>	500-1000	None
<i>Loyalist Volunteer Force (LVF), (Northern Ireland)</i>	Approx. 24	None

<i>Moroccan Islamic Combatant Group (GICM), (Western Europe)</i>	Unknown	None
<i>New Red Brigades/Communist Combatant Party (BR/PCC), a.k.a.: Brigade Rosse/Partito Comunista Combattente, (Italy)</i>	< 20	None
<i>The Palestine Islamic Jihad (PIJ), (Syria)</i>	Unknown	None
<i>Popular Front for the Liberation of Palestine (PFLP), (Syria)*</i>	Unknown	None
<i>Popular Front for the Liberation of Palestine-General Command (PFLP-GC), (Syria)*</i>	Several hundred	None
<i>Qibla and People Against Gangsterism and Drugs (PAGAD), a.k.a.: Muslims Against Global Oppression (MAGO), Muslims Against Illegitimate Leaders (MAIL), (South Africa)*</i>	Unknown (Est. several hundred)	None
<i>Real IRA (RIRA), a.k.a.: True IRA, (Northern Ireland)</i>	<100	None
<i>Red Hand Defenders (RHD), (Northern Ireland)</i>	Approx. 20	None
<i>Revolutionary Nuclei (RN), a.k.a.: Revolutionary Cells, (Greece)*</i>	Unknown (Est. to be small)	Yes
<i>Revolutionary Organization 17 November, a.k.a.: 17November, (Greece)*</i>	Unknown (Est. to be small)	Yes
<i>Revolutionary People's Liberation Party/Front (DHKP/C), a.k.a.: Devrimci Sol, Revolutionary Left, Dev Sol, (Turkey)*</i>	Several dozen	Yes
<i>Revolutionary People's Struggle (ELA), (Greece)*</i>	Unknown	Yes
<i>Revolutionary Proletarian Initiative Nuclei (NIPR), (Italy)*</i>	Approx. 12	Yes
<i>Riyadus-Salikhin Reconnaissance and Sabotage Battalion of Chechen Martyrs (RSRSBCM), (Chechnya)</i>	≤ 50	None
<i>The Salafist Group for Call and Combat (GSPC), (Algeria)</i>	Unknown (Est. several hundred)	None
<i>Special Purpose Islamic Regiment (SPIR), (Chechnya)</i>	≤ 100	None
<i>The Tunisian Combatant Group (TCG), a.k.a.: Jama'a Combattante Tunisienne, Tunisian Islamic Fighting Group, (Tunisia)*</i>	Unknown	Yes

<i>Turkish Hizballah, (Turkey)</i>	Est. several hundred members Several thousand supporters	None
<i>Ulster Defense Association/Ulster Freedom Fighters (UDA/UFF), (Northern Ireland)</i>	Est. 2,000 – 5,000	None
<i>Ulster Defense Force (UVP), (Northern Ireland)</i>	Unknown (Est. several hundred)	None
<i>Zviadists, (Georgia) (Listed in the 2003 State Department Report-Deleted in 2004)</i>	Unknown	None

Table A-5. Terrorist Groups Based in USEUCOM

<i>Other Groups Operating or with Presence in the AOR</i>	
<i>Abu Nidal Organization (ANO)*</i>	<i>Aum Supreme Truth (Aum)</i>
<i>Al-Gama'a al-Islamiyya (IG)*</i>	<i>Mujahedin-e Khalq Organization (MEK)*</i>
<i>Al-Jihad*</i>	<i>Palestine Liberation Front (PLF)*</i>
<i>Al Qaeda*</i>	

Table A-6. Terrorist Groups with Presence in USEUCOM

U.S. Central Command

<i>Groups Physically Based In AOR</i>	<i>Strength</i>	<i>Anti-U.S. Activity</i>
<i>Abu Nidal Organization (ANO), a.k.a.: Fatah Revolutionary Council, Arab Revolutionary Brigades, Black September, Revolutionary Organization of Socialist Muslims, (Iraq)*</i>	Few hundred	Yes
<i>Al-Badhr Mujahidin (al-Badr), (Pakistan)</i>	Several hundred	None
<i>Al-Gama'a al-Islamiyya (IG), a.k.a.: Islamic Group, (Egypt)*</i>	Unknown	Yes
<i>Al-Ittihad al-Islami (AIAI), a.k.a.: Islamic Union, (Somalia)</i>	2,000 +	None

<i>Al-Jihad, a.k.a.: Egyptian Islamic Jihad, Jihad Group, (Egypt)*</i>	Unknown (Est. several hundred)	Yes
<i>Al-Qaeda, a.k.a.: Qa'idat al-Jihad, (Afghanistan/Pakistan)*</i>	Several thousand	Yes
<i>Ansar al-Islam (AI), a.k.a.: Partisans of Islam, Helpers of Islam, Supporters of Islam, Jund al-Islam, Jaish Ansar al-Sunna, (Iraq)*</i>	Approx. 700 – 1,000	Yes
<i>Harakat ul-Ansar (HUA), (Pakistan)*</i>	Several thousand	Yes
<i>Harakat ul-Jihad-I-Islami (Movement of Islamic Holy War) (HUJI), (Pakistan)</i>	Unknown (Est. several hundred)	None
<i>Harakat ul-Mujahidin (Movement of Holy Warriors) (HUM), a.k.a.: Jamiat ul-Ansar (JUA), (Pakistan)*</i>	Several hundred	Yes
<i>Hizb-I Islami Gulbuddin (HIG), (Afghanistan/Pakistan)*</i>	Several hundred	Yes
<i>Islamic Army of Aden (IAA), a.k.a.: Aden-Abyan Islamic Army (AAIA), (Yemen)*</i>	Unknown	Yes
<i>Islamic Movement of Uzbekistan (IMU), (Uzbekistan)*</i>	< 500	Yes
<i>Jaish-e-Mohammed (Army of Mohammed) (JEM), (Pakistan)</i>	Several hundred	None
<i>Lashkar-e-Tayyiba (Army of the Righteous) (LT), a.k.a.: Jamaat ud-Dawa (JUD), (Pakistan)</i>	Several thousand	None
<i>Lashkar I Jhangvi (Army of Jhangvi) (LJ), (Pakistan)*</i>	< 100	Yes
<i>Mujahedin-e Khalq Organization (MEK or MKO), a.k.a.: National Liberation Army of Iran (NLA), People's Mujahidin of Iran (PMOI), National Council of Resistance (NCR), National Council of Resistance of Iran (NCRI), Muslim Iranian Student's Society, (Iraq)*</i>	Several thousand (3,800 confined to Camp Ashraf)	Yes
<i>Palestine Liberation Front (PLF) (Iraq)*</i>	Unknown	Yes
<i>Sipah-I-Sahaba/Pakistan (SSP), (Pakistan)</i>	3000-6000	None

Table A-7. Terrorist Groups Based in USCENTCOM

<i>Other Groups Operating or with Presence in the AOR</i>	
<i>Al-Jama'a al-Islamiyyah al-Muqatilah bi-Libya</i>	<i>Japanese Red Army (JRA)*</i>

<i>Eastern Turkistan Islamic Movement (ETIM)*</i>	<i>Kurdistan Worker's Party (PKK)</i>
<i>HAMAS</i>	<i>Libyan Islamic Fighting Group</i>
<i>Hizballah*</i>	<i>Moroccan Islamic Combatant Group (GICM)</i>
<i>Hizb ul-Mujahidin (HM)</i>	<i>Palestine Islamic Jihad (PIJ)</i>
<i>Jamaat ul-Fuqra*</i>	<i>Popular Front for the Liberation of Palestine-General Command (PFLP-GC)</i>
<i>Jamiat ul-Mujahidin (JUM)</i>	<i>The Tunisian Combatant Group (TCG)*</i>

Table A-8. Terrorist Groups with Presence in USCENTCOM

U.S. Pacific Command

<i>Groups Physically Based In AOR</i>	<i>Strength</i>	<i>Anti-U.S. Activity</i>
<i>Abu Sayyaf Group (ASG) (Philippines)*</i>	200 - 500	Yes
<i>Alex Boncayao Brigade (ABB) (Philippines)*</i>	Approx. 500	Yes
<i>Al-Ummah, (India) (Listed in the 2003 State Department Report-Deleted in 2004)</i>	Unknown	None
<i>Aum Supreme Truth (Aum), a.k.a.: Aum Shinrikyo, Aleph, (Japan)</i>	1,650	None
<i>Cambodian Freedom Fighters (CFF), a.k.a.: Cholana Kangtoap Serei Cheat Kampouchea, (Cambodia)</i>	Unknown (Est. < 100)	None
<i>Chukaku-Ha (Nucleus or Middle Core Faction), (Japan)</i>	3,500	None
<i>The Communist Party of Nepal (Maoist)/United People's Front, (Nepal)*</i>	Several thousand	Yes
<i>Communist Party of the Philippines/New People's Army (CPP/NPA), (Philippines)*</i>	< 9,000	Yes
<i>Eastern Turkistan Islamic Movement (ETIM), (China)*</i>	Unknown	Yes

<i>Harakat ul-Jihad-I-Islami/Bangladesh (Movement of Islamic Holy War) (HUJI-B), (Bangladesh)</i>	> Several thousand	None
<i>Hizb ul-Mujahidin (HM), (India-Kashmir)</i>	Unknown (Est. several hundred to over 1000)	None
<i>Jamiat ul-Mujahidin (JUM), (India-Kashmir)</i>	Unknown	None
<i>Jemaah Islamiya (JI), (Malaysia and Singapore)*</i>	Unknown (Est. several hundred to several thousand)	Yes
<i>Khmer Rouge/The Party of Democratic Kampuchea, (Cambodia) (Listed in the 2003 State Department Report-Deleted in 2004)</i>	100 – 500	None
<i>Kumpulan Mujahidin Malaysia (KMM), (Malaysia)*</i>	Unknown	Yes
<i>Liberation Tigers of Tamil Eelam (LTTE), a.k.a.: World Tamil Association (WTA), World Tamil Movement (WTM), Federation of Associations of Canadian Tamils (FACT), Ellalan Force, Sangilian Force, (Sri Lanka)</i>	Unknown (Est. 8,000 – 10,000)	None
<i>Maoist Communist Center of India (MCCI), a.k.a.: The Maoist Communist Center (MCC) and Naxalites, (India)</i>	31,000	None
<i>United Liberation Front of Assam (ULFA) (India)</i>	Est. 700	None

Table A-9. Terrorist Groups Based in USPACOM

<i>Other Groups Operating or with Presence in the AOR</i>	
<i>Abu Nidal Organization (ANO)*</i>	<i>Harakat ul-Mujahidin (HUM)*</i>
<i>Al-Badhr Mujahidin (al-Badr)</i>	<i>Hizballah*</i>
<i>Al-Gama'a al-Islamiyya (IG)*</i>	<i>Jaish-e-Mohammed (JEM)</i>
<i>Al Qaeda*</i>	<i>Japanese Red Army (JRA)*</i>
<i>Harakat ul-Ansar (HUA)*</i>	<i>Lashkar-e-Tayyiba (LT)</i>

<i>Harakat ul-Jihad-I-Islami (HUJI)</i>	<i>Mujahedin-e Khalq Organization (MEK)*</i>
---	--

Table A-10. Terrorist Groups with Presence in USPACOM

Groups marked with an asterisk have conducted operations in one or more areas against U.S. targets.

Page Intentionally Blank

Appendix B Terrorist Planning Cycle

The main point is to select targets where success is 100% assured.

Dr. George Habash, Founder, PFLP
(Popular Front for the Liberation of Palestine)

Terrorist operations are typically prepared to minimize risk and achieve the highest probability of success. They focus on avoiding the opponents’ strengths and concentrating on their weaknesses. Emphasis is on maximizing security and target effects. In practice that means the least number of personnel, and the most effective²⁶⁸ weapons practicable. To accomplish this, extensive planning is conducted, with an emphasis on target surveillance and reconnaissance.

Collection against potential targets may continue for years before an operation is decided upon. While some targets may be “soft” enough for shorter periods of observation, the information gathering will still be intense. Also, operations planned or underway may be altered, delayed, or cancelled entirely due to changes to the target or local conditions.

Terrorists plan campaigns to combine successive achievements of operational objectives into accomplishing strategic goals. Even though we refer to a terrorist operation having a physical “objective,” this physical objective is in reality an intermediate objective. The casualties, destruction, or threats thereof that the operation accomplishes must be properly exploited to reach the target audience. The psychological impact on that audience is the true objective of any terrorist operation. While the assassination of a troublesome police official may provide other tactical advantages, it is the psychological effect on the target audience and its ultimate support of strategic goals that is the true objective. This has been seen extensively in Iraq as terrorists targeted Iraqis serving in provisional Government positions in 2004.

There is no universal “staff school” model for terrorist

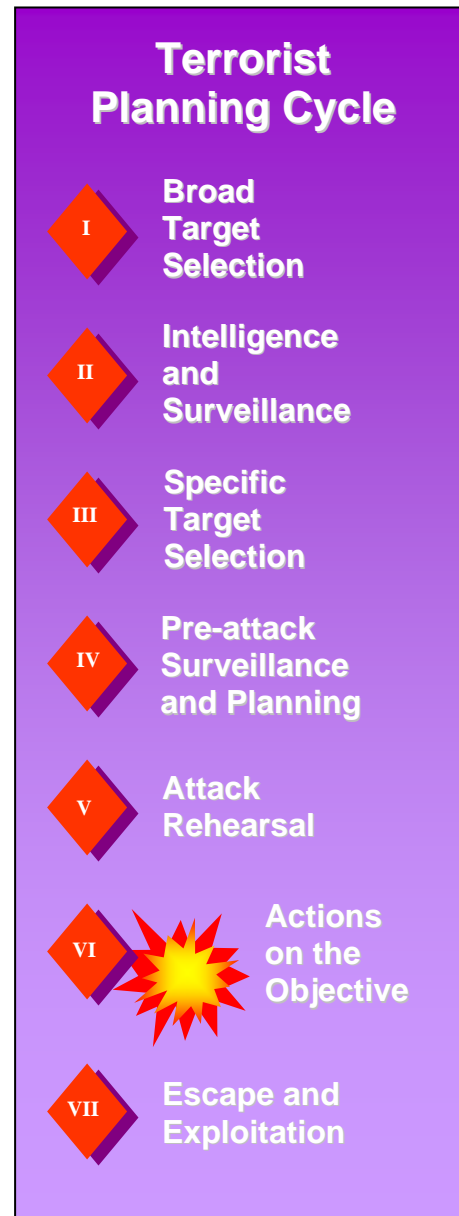

Figure B-1.
Terrorist Planning Cycle

²⁶⁸ Note: “Effective” in this case need not mean modern or destructive, but most suitable to cause the desired target effects. Knives, machetes, and other edged weapons have been extensively used against terrorist victims in the modern era because target audiences view them as particularly bloody and barbarous.

planning, but experience and success has shown terrorists what works for effective plans and operations. Terrorist organizations exchange personnel and training with each other, and study the methods and operational successes of groups they have no direct contact with. Innovation is a proven key component of operational success. Using new weapons or technology, or old systems in innovative, unexpected ways, allows terrorists to defeat or avoid defensive measures.

Terrorist operational planning can be analyzed according to requirements common to all operations. The planning and operation cycle in Fig. B-1 is valid for traditional hierarchically organized groups, as well as the decentralized “network” type organizations. The differences between the two organizations are the location of decision making at the various steps of the cycle, and the method of task organizing and providing support for the operation.

Phase I: Broad Target Selection

“Information gathering is a continuous operation...”

*Irish Republican Army’s Handbook
for Volunteers of Irish Republican Army, 1956.*

This phase is the collection of information on a large number of potential targets, some of which may never be attacked, or seriously considered for attack. Personnel that are not core members of the terrorist organization, but are either sympathizers or dupes, and who may not be aware of what their information will be used for, often conduct this data collection. This phase also includes open source and general information collection. Some features of this type of collection are:

- Stories from newspapers, other media, and journalistic sources often provide key information on the target.
- Internet research provides texts, pictures, blue prints, and video information.
- Potential targets are screened based on symbolic value and their potential to generate high profile media attention. Objectives of the terrorist group influence the selection of a person or facility as a worthy target. This includes the likely casualty rate achieved by the attack.

The number of preliminary targets that can be screened is limited only by the capabilities of the group to collect information from sympathizers and open sources. Targets that are considered vulnerable and which would further the terrorist organization’s goals are selected for the next phase of intelligence collection.

Phase II: Intelligence Gathering and Surveillance

Targets showing potential vulnerabilities are given a higher priority of effort. This priority establishes the requirement to gather additional information on the targets' patterns over time. Examples include the 2004 accounts of terrorist surveillance conducted for years on the International Monetary Fund, Prudential Building, New York Stock Exchange, as well as facilities in Las Vegas, Nevada. The type of surveillance employed depends on the target type. Elements of information typically gathered include:

- Practices/Procedures/Routines – For facilities this includes scheduled deliveries, work shift changes, identification procedures and other observable routines. For individuals, it can include regularly scheduled errands (laundry pick up every third day, etc.) and appointments.
- Residence & Workplace – This category applies primarily to the physical layout and individual activities at the two places the target typically spends the most time.
- Transportation/Routes of Travel – For individuals, this is the mode of transport and common routes to any regular destination (house, work, gym, school, etc.). For facilities, it addresses ingress and egress points, types of vehicles allowed on the grounds, or availability of transportation into the target site.
- Security Measures – This topic includes a myriad of potential collection areas, depending on the complexity of the security around the target. Presence of a guard force; the reaction time of response units; any hardening of structures, barriers, or sensors; personnel, package, and vehicle screening procedures; and the type and frequency of emergency reaction drills are examples of key collection objectives. This is one of the most important areas of information for attack site selection, since the intent is to bypass and avoid security measures, and be able to strike the target during any period.

Phase III: Specific Target Selection

Selection of a target for actual operational planning considers some of the following factors:

- Does success affect a larger audience than the immediate victim(s)?
- Will the target attract high profile media attention?
- Does success make the desired statement to the correct target audience(s)?
- Is the effect consistent with objectives of the group?
- Does the target provide an advantage to the group by demonstrating its capabilities?
- What are the costs versus benefits of conducting the operation?

A decision to proceed requires continued intelligence collection against the chosen target. Targets not receiving immediate consideration will still be collected against for future opportunities.

Phase IV: Pre-attack Surveillance and Planning

Members of the actual operational cells begin to appear during this phase. Either trained intelligence and surveillance personnel, or members of the cell organized to conduct the operation conduct this phase. Consequently, the level of intelligence tradecraft and operational competency correspondingly increases. This phase gathers information on the target's current patterns over time, usually days to weeks. It allows the attack team to confirm the information gathered from previous surveillance and reconnaissance activities. The areas of concern are essentially the same as in Phase II, but with greater focus based upon the planning conducted thus far.

The type of surveillance employed depends on the target's activities. The information gained is then used to:

- Conduct security studies.
- Conduct detailed preparatory operations.
- Recruit specialized operatives (if needed).
- Procure a base of operations in the target area (safe houses, caches, etc.).
- Design and test escape routes.
- Decide on type of weapon or attack.

Phase V: Rehearsals

As with conventional military operations, rehearsals are conducted to improve the odds of success, confirm planning assumptions, and develop contingencies. Terrorists also rehearse to test security reactions to particular attack profiles. Terrorists use both their own operatives and unwitting people to test target reactions.

Typical rehearsals include:

- Deployment into target area.
- Actions on the objective.
- Escape routes.
- Equipment and weapon performance.

Tests in the target area will be conducted to confirm:

- Target information gathered to date.
- Target pattern of activities.
- Physical layout of target or operation area.
- Security force reactions (state of alert, timing, size of response, equipment, routes).

Phase VI: Actions on the Objective

Once terrorists reach this stage of their program, the odds are clearly against the target. Several different analyses conclude that once operations are initiated, the success rate for the terrorist is in the ninety-percent range. Terrorists will minimize time spent conducting the actual operation to reduce their vulnerability to discovery or countermeasures. With the exception of barricade-style hostage taking operations, terrorists plan to complete their actions before even nearby security forces can react.

Terrorists conducting planned operations possess important tactical advantages. Since they are the attacker, they possess all the advantages of initiative, giving them:

- Surprise.
- Choice of time, place, and conditions of attack.
- Employment of diversions and secondary or follow-up attacks.
- Employment of security and support positions to neutralize target reaction forces and security measures.

Because of the extensive preparation through surveillance and reconnaissance, enemy security measures will be planned for and neutralized. Any countermeasure can be countered in turn. If security cameras are detected, they can be avoided or disabled as necessary. Guards can be overcome or killed. Hardened vehicles or buildings will result in the use of larger or more effective explosive devices or direct fire weapons. Although security measures may complicate the attackers' problems, they do not confer any guarantee against attack.

Phase VII: Escape and Exploitation

Escape plans are usually well rehearsed and executed. Many terrorists want to survive the operation and escape. It further enhances the effect of fear and terror from a successful operation if the perpetrators get away "clean." The exception to this is a suicide operation, where the impact is enhanced by the willingness to die in achieving the attack. Even in suicide attacks, however, there are usually support personnel and "handlers" who must deliver the suicide asset to the target, and subsequently make their escape.

Exploitation is the primary objective of the operation. The operation must be properly exploited and publicized to achieve its intended effect. Media control measures, prepared statements, and a host of other preparations are made to effectively exploit a successful operation. These will be timed to take advantage of media cycles for the selected target audiences.

Unsuccessful operations are disavowed when possible. The perception that a group has failed severely damages the organization's prestige and makes it appear vulnerable, or worse, ineffective. Once a terrorist organization is perceived as ineffective, it is very difficult to impact target audiences.

In addition to the impact on the opponent, successful attacks bring favorable attention, notoriety and support (money, recruits, etc.) to the group conducting them. If the group conducting the operation subscribes to a revolutionary ideology, they will see each success as gradually inspiring more revolutionary fervor in the population. Any success encourages the terrorists to conduct further operations, and improves their ability to do so through increased support and experience.

Appendix C

Terrorist Operations and Tactics

Not believing in force is the same as not believing in gravity.

Leon Trotsky

General

The discussion below presents the most common types of terrorist operations and tactics. By no means is this intended to be an exhaustive discussion of this topic since the combination of methods and approaches is virtually unlimited. However, one constant regarding terror operations is the use of techniques stressing surprise, secrecy, innovation, and indirect methods of attack. Their tactics are as broad and diverse as the imagination of the group's members. Additionally, with the use of the Internet and common training bases, terrorist groups exchange information on tactics that yield success. Al Qaeda alone has assembled in excess of 10,000 pages of written training material, more than a hundred hours of training videos, and operates a worldwide network of training camps.²⁶⁹ Additionally, they have been able to field test their tactics in real-world situations since many of the terrorists have participated in conflicts such as Chechnya, Kashmir, Afghanistan, the Balkans, and Iraq.

Contemporary Setting

For military professionals, a key principle to keep in mind is the difference in outlook between terror operations and military operations. The terrorist will utilize tactics, forces, and weapons specifically tailored to the particular mission. Terrorist operations are individualistic, in that each is planned for a specific target and effect. Additionally, terrorists will only expose as much of their resources and personnel to capture or destruction as are absolutely necessary for mission accomplishment. A military force would approach an



Figure C-1: **Khobar Towers** (Source: DOD Photo)

operation with plans to concentrate forces and keep excess combat power on hand to meet contingencies, ensure mission success, and prepare for follow-on missions. A terrorist takes a minimal force and relies upon prior planning and reconnaissance to match the force, weapons,

²⁶⁹ Ben Venzke and Aimee Ibrahim, *The al-Qaeda Threat, An Analytical Guide to al-Qaeda's Tactics & Targets* (Alexandria: Tempest Publishing, 2003), 7.

and methods to the target. There is no concept of “follow-on missions”, so there is no need for redundant capability. If changes to the target, or unexpected conditions render success unlikely, he will usually cancel the operation and return later with a better weapon, an updated plan, more personnel, or whatever it may require to ensure a successful operation. For major terrorist operations, mission accomplishment will in all likelihood mean the disbanding of the force, personnel returning to their cells and covers, or forming new task groups for other operations.

In addition to adaptive and flexible organizations, terrorists also employ specific equipment built or procured for a particular operation. Because of the lag time between development of a new technology and military acquisition and fielding, terrorists can sometimes procure equipment superior to standardized military models. As an example, instead of purchasing hundreds of identical radios constructed to meet all likely uses, a terrorist will only procure the quantity he needs of the newest, most capable radio appropriate for the operation. The only real limitation is funding and availability of the equipment when it is needed.

Weapons will also be tailored to the particular operation. If a directional explosive is needed, the terrorist could make use of available military models of anti-tank and anti-personnel mines. Conversely, the terrorist may determine that a mine would be detected by the target’s security force en route to the attack, and he therefore needs to build or obtain an alternative device. To illustrate, even counting the warheads of anti-ship cruise missiles, there was not a readily available weapon for the attack on the USS *Cole*. No one manufactures a half-ton C-4 platter charge configured to fit in a small boat,²⁷⁰ but that was exactly what the terrorist’s plan required. Therefore it was exactly what the terrorist group built. Additionally, Operation Iraqi Freedom has demonstrated the terrorists’ ability to construct a variety of IEDs that are effective, yet are easily emplaced and difficult to detect by military forces.

Objectives of the group(s) conducting the operation are key to predicting likely targets. Is the intent to cause loss of faith in the authorities, a provocation to inspire resistance, to promote fear amongst the population, or to inflict military casualties in an attempt to reduce national and political will? Although several different types of operations may satisfy a particular objective, terror groups often develop expertise in one or more types of operations, and less specialization in others.

Some groups will actually publish their targeting guidance. In March 2004, al Qaeda published a 9-page article in their training publication, “Camp al-Battar Magazine” that released new targeting guidance to its members and other affiliated groups. This publication contains information on everything from small arms skills, physical fitness, targeting, tactics, and secure communications. The new guidance specifically covered targets within cities, addressing faith targets, economic targets, and human targets.²⁷¹

²⁷⁰ John McWethy et al., no title, *ABCNews.Com*, 18 October 2000; available from <http://www.abcnews.go.com/sections/world/DailyNews/cole001018b.html>; Internet; accessed 9 January 2003.

²⁷¹ Ben N. Venzke, *al Qaeda Targeting Guidance* - Version 1.0 (Alexandria, VA: IntelCenter/Tempest Publishing, LLC, 2004), 3-5.

Forms of Terrorism



Threat or Hoax

A terrorist group can use threats to coerce or preclude actions by a targeted individual or population. Threats and hoaxes can dull the effectiveness of preventive or countermeasures when a targeted individual or population loses situational awareness of an actual terrorist target, or disperses finite assets against many possible threats.

At the less lethal end of the spectrum, hoaxes can simply be methods to annoy and wear down security forces, and keep the population constantly agitated. Fake bomb threats, leaving suspicious items in public places, and talcum powder “anthrax” attacks bleed time and effort from other security operations, and contribute to uncertainty and fear.

Such activities can be used to gain information about the target’s response to a potential attack. Where the occupants go during the evacuation of a building, and how long it takes them to exit are useful elements of information in operational planning, and can be obtained through simply making an anonymous phone call or activating a fire alarm. Observation of regularly scheduled exercises or drills of emergency response procedures can provide similar information.

This technique can also be combined with an actual attack to circumvent fixed security measures. For example, the occupants of a bomb-resistant building with controlled access and a guard force could be forced to evacuate by a plausible, but false, threat. Many security plans would respect the potential danger such a threat represented, and evacuate the building. Unless properly secured, the evacuation has made the occupants more vulnerable to such weapons as a car bomb or other mass casualty techniques placed near the exits, or at a designated assembly point.

Extortion is one example of a threat that obtains money, materiel, information, or support by force or intimidation. Extortion is often used during the formative period of a group or by groups that fail to develop more sophisticated financial skills. However, the opportunity to engage in more lucrative money making activities, such as drug trafficking, may eventually replace the need to extort by some groups. Extortion takes the form of “war taxes” or protection money. Depending on the structure of the terrorist organization, the logistics and

support cells extort money from local businesses in exchange for protection, which means not harming or bothering the business or its members. Members of the intelligence cells may also extort to collect required information.

The Basque terrorists are an excellent example of a group that uses extortion. They have extorted money for years from businesses to finance their battle for independence. When Spain converted from the peseta to the euro, ETA even sent letters to Basque businesses demanding payments ranging from 30,000 to 60,000 euros. Although many of the large companies in the Basque region refuse to pay ETA's "revolutionary tax", smaller businesses that cannot afford to hire bodyguards are forced to pay.²⁷²

Another form of extortion is intimidation. Intelligence cells or a specialized team intimidates people to obtain information on the group's enemy or to provide resources. Death threats against an individual or his family cause him to provide information or resources to a group with which he has no interest. A terrorist group also intimidates people not to take action. For example, enemy security personnel may not implement required security measures because of intimidation. The information cell of a terrorist group helps create and maintain the fear caused by extortion through its propaganda and deception actions.

The power of extortion and blackmail as a means of coercing individuals should not be underestimated. Several terrorist groups have successfully used these techniques to force individuals to carry out suicide bombing missions.

Arson

Arson is a destructive technique using fire, usually in sabotage operations against property. It permits a significant destructive effect with simple equipment and little training. It is one of the most commonly used methods of terrorist attack, ranking only behind bombing and assassination in total numbers covering the period 1980 - 1999.²⁷³

Since arson is primarily used against property, it is not normally considered as a casualty producer. However, arson can still result in fatalities, as an intentional or unintentional effect. Arson is most often used for symbolic attacks and economic effects. Single-issue groups, such as the Earth Liberation Front (ELF), particularly favor it for these purposes. Although ELF has claimed responsibility for dozens of arsons, probably the most costly arson committed by this group was in San Diego in August 2003. Claiming it was targeting "rampant urban development," ELF started a fire that caused an estimated \$50 million worth of damage in San Diego's fast-growing northern edge.²⁷⁴

²⁷² "Terrorists Demand Extortion Cash in Euros," *TCM Breaking News* (4 September 2001): 1; available from <http://archives.tcm.ie/breakingnews/2001/09/04/story22584.asp>; Internet; accessed 31 March 2004.

²⁷³ Department of Justice, Federal Bureau of Investigation, Counterterrorism Threat Assessment and Warning Unit, Counterterrorism Division, *Terrorism in the United States 1999*, Report 0308, (Washington, D.C., n.d.), 41.

²⁷⁴ Seth Hettena, "Earth Liberation Front Claims Responsibility for San Diego Arson," *The Mercury News*, 18 August 2003; available from <http://www.mercurynews.com/mld/mercurynews/news/local/6562462.htm>; Internet; accessed 17 March 2004.

Sabotage

Sabotage is the planned destruction of the enemy's equipment or infrastructure. The purpose of sabotage is to inflict both psychological and physical damage. This can result from an incident creating a large number of casualties or from a severe disruption of services for the population. Sabotage demonstrates how vulnerable the enemy is to the terrorist group's actions. Destroying or disrupting key services or facilities impresses the power of the saboteur on the public consciousness, and either increases their frustration with the ineffectiveness of the government, or inspires others to resist.

A terrorist group normally aims its sabotage actions at elements of infrastructure, in order to reinforce the perception that nothing is safe. The action can have significant economic impacts, as well as the additional effects of creating mass casualties. Oil pipelines, water purification plants, sewage treatment facilities, air traffic control hubs, and medical treatment or research facilities are just a few examples of potential targets. Terrorist groups use many techniques, such as bombing, arson, cyber, or use of contaminants, to conduct sabotage.

Examples of sabotage have been evident in Iraq since the end of major combat operations where attacks have been conducted against power generation facilities and water pipelines. Additionally, attacks on Iraq's oil pipeline have been persistent and estimates in September 2003 were that the country was losing \$7 million daily because of damage to the pipeline that carried oil from the Kirkuk fields to a Mediterranean port in Turkey.²⁷⁵

Bombing

Bombs are the favored weapon for terrorists²⁷⁶ for a variety of reasons. They are highly destructive, are flexible enough to be tailored to the mission, do not require the operator to be present, and have a significant psychological impact. To demonstrate their prominence in terrorist operations, 324 out of 482 total terrorist incidents or planned acts in the U.S. between 1980-2001 were bombings,²⁷⁷ and 119 of 208 international terrorist incidents in 2003 were bombings.²⁷⁸

Bombs have a significant historical record, and a particular place in early anarchist and revolutionary thought, where dynamite was viewed as the equalizing force between the state and the individual.²⁷⁹ There is little question that terrorist groups have a wealth of knowledge about building and planting these devices. As stated earlier in Chapter 3 of the handbook, the interaction between groups using both the Internet and through common training sites has facilitated the proliferation of effective devices and tactics throughout the terrorist network.

²⁷⁵ "Saboteurs Disable Critical Iraqi Oil Pipeline," *HoustonChronicle.com*, 8 September 2003; available from <http://www.chron.com/cs/CDA/ssistory.mpl/special/iraq/2087438>; Internet; accessed 16 January 2004.

²⁷⁶ *Encyclopedia of World Terror*, 1997 ed., s.v. "Bombing."

²⁷⁷ Department of Justice, Federal Bureau of Investigation, Counterterrorism Division, *Terrorism 2000/2001*, Report 0308, (Washington, D.C., 2004).

²⁷⁸ Department of State, Office for Counterterrorism, *Patterns of Global Terrorism 2003* (Washington, D.C., April 2004, revised 22 June 2004), 5.

²⁷⁹ Walter Reich, ed., *Origins of Terrorism: Psychologies, Ideologies, Theologies, States of Mind*, rev. ed. (Washington: Woodrow Wilson Center Press, 1998), 264-265.

Bombings may be used as a technique to conduct other operations, such as sabotage or assassination, or can simply be a tactic to cause terror through the destruction and casualties produced by an explosion. Terrorists often use them to demonstrate how vulnerable the population truly is to attacks regardless of measures taken by a government to protect them.

Methods of delivering bombs are only limited by the imagination of the group planning the attack, and the capabilities of the individual bomb manufacturer. In recent history, directional bombs disguised as bricks in roadside walls and radio command detonated were used in the Israeli-occupied territories. The IRA has developed methods of remote detonation using police laser speed detection devices that can detonate a bomb programmed to respond to a particular laser pulse within line of sight, and that is immune to the usual electronic countermeasures for radio controlled bombs.²⁸⁰



Figure C-3 Car Bomb
(Source: U.S. Army Photo)

Car bombs commonly referred to as vehicle borne improvised explosive devices (VBIED), are also a very common method used by terrorists to deliver a bomb to its target. Besides the use of airplanes as VBIEDs on 11 September 2001 to hit the World Trade Center and the Pentagon, probably the best-known domestic incident occurred on April 19, 1995, when a truck bomb exploded outside the Alfred P. Murrah building in Oklahoma City killing 168 people and injuring hundreds. Timothy McVeigh was convicted and later executed for the bombing. Overseas, the suicide truck bombing of the Marine Barracks in Beirut in October 1983 killing 241 Americans and the truck bomb that exploded near the Khobar Towers military barracks in Dhahran, Saudi Arabia on June 25, 1996 killing 19 people and injuring over 500 people are probably the most publicized incidents.

Although usually deployed as a single device, the Department of Homeland Security recently distributed a warning reflecting new tactics being used by terrorists in this area based on the bombings in Riyadh, Saudi Arabia in May 2003. These included terrorists hitting multiple targets, conducting simultaneous attacks, using multiple vehicles per target, and using assault/breaching personnel armed with small arms to accompany the VBIED to clear security personnel and gain access to the target area.²⁸¹

In 2003, the use of bombs, and in particular improvised explosive devices (IEDs) reached an all time high in both lethality and employment techniques used by terrorists against their targets. Terrorists/insurgents have mastered the employment of roadside explosives to attack both individuals and motorcades/convoys. Many IEDs are bulky devices often made from artillery shells and detonated with garage door openers or doorbells. However, terrorists are now producing smaller devices that can be planted quickly and can be detonated from longer distances. Employment techniques include emplacing multiple devices along both sides of a

²⁸⁰Bruce Hoffman, *Inside Terrorism* (New York: Columbia University Press, 1998), 181.

²⁸¹National Security Institute, *Homeland Security Warns about Vehicle Bombs*, (Medway, MA, n.d.), 1-4; available from http://nsi.org/Library/Terrorism/Vehicle_Bombs.doc; Internet; accessed 14 January 2004.

road, sometimes disguised as trash or even hidden in animal carcasses that are daisy chained to explode simultaneously. Additionally, fake devices are often planted in an obvious spot to waste the time of explosive ordnance detachment personnel or to draw targets into an ambush.

Terrorist use of bombs is not restricted to roadside attacks or VBIEDs. Devices are often placed at a target site and then remotely detonated. One of the most recent terrorist bombing attacks occurred in Spain in March 2004. Ten backpack bombs with nails and screws packed around the explosives for shrapnel were detonated on four trains almost simultaneously using cell phones as the initiation device.²⁸² The results were nearly 200 dead and over 1,400 wounded. At the time of this writing, a multinational cell of al Qaeda loyalists is thought to be behind the bombings.

Appendix E contains descriptions of a variety of Improvised Explosive Devices (IEDs) that may be built by minimally competent terrorist groups. Appendix F discusses conventional weapons and unexploded ordnance (UXO) that can be adapted to use by terrorist organizations.

Kidnapping

Kidnapping is usually an action taken against a prominent enemy individual for a specific reason. The most common reasons for kidnapping are ransom, release of a fellow terrorist, or the desire to publicize a demand or an issue. The terrorist group conducts detailed planning, especially regarding movement of the kidnapped individual. The risk in kidnapping is relatively lower than in hostage taking primarily because the kidnapped victim is moved to a location controlled by the group. The group makes demands and is willing to hold a victim for a significant time, if necessary.

The success of kidnapping relies upon balancing the cost to the government represented by the threat of harm to the victim, with the costs of meeting the kidnappers' demands. Some kidnapping operations are actually assassinations, as the death of the victim is intended from the start. The terrorists intended objective in this case being the intermediate concessions and publicity obtained during the negotiation process that they would not receive from a simple assassination.

Kidnapping (and hostage taking) can also be used as a means of financing the organization. Ransom from seized individuals or groups are a significant slice of income for groups in several regions of the world. Latin America has long been a victim of terrorist kidnapping, especially by the FARC and ELN in Colombia. The Abu Sayyaf Group in the Philippines also uses this method to finance their operations. Although the sizes of the ransoms vary, they often can be quite large. Ten employees of a Spanish energy consortium were kidnapped in Ecuador in October 2000 by kidnappers believed to be linked to the Popular Liberation Army of Colombia. The oil companies eventually paid \$13 million in ransom for their release.

An example of the U.S. military's experience with kidnapping is the case of USMC Col. William (Rich) Higgins. He disappeared on May 17, 1988, while serving as the Chief,

²⁸² Lou Dolinar, "Cell Phones Jury-rigged to Detonate Bombs," *Newsday.com*, 15 March 2004; available from <http://www.newsday.com/news/nationworld/ny-wocell153708827mar15.0,1644248.story?coll=ny-nationworld-headlines>; Internet; accessed 15 March 2004.

Observer Group Lebanon and Senior Military Observer, United States Military Observer Group, United Nations Truce Supervision Organization. He was kidnapped and held by Iranian-backed Hizballah terrorists and later murdered. A picture of his body hanging from a noose was released to the news media in July 1989. His remains continued to be held until they were released in December 1991.

Another example was the kidnapping of Brigadier General James Dozier, senior American official at a NATO headquarters in Verona, Italy, by Red Brigade terrorists on December 17, 1981. The targeting of General Dozier broke the pattern of previous terrorist activities in Italy since terrorist groups had previously concentrated their actions against key Italian personalities, such as senior Italian politicians, industrialists, jurists, newspaper publishers and police officials. Following General Dozier's kidnapping, numerous additional threats were received which provided a clear indication that the situation had changed in Italy and other Americans and U.S. facilities were potential targets for terrorist actions.²⁸³

The terrorists conducted surveillance of General Dozier's residence for at least 30 days from positions in a park and at a bus stop across from the building. The techniques used were young people standing at the bus stop and young couples in the park area. Additionally, the terrorists had been in his apartment at least twice while posing as meter readers. Two men pretending to be plumbers conducted the actual kidnapping. They told General Dozier that there was a leak in the apartment below and wanted to determine if it was coming from Dozier's apartment. Since leaks were common in the building, he let them into the apartment, at which time the kidnapping was executed. After being held for 42 days, he was rescued by Italian police.²⁸⁴

Kidnapping and periodic murder of victims is a recurring technique of terrorists. A number of recent civilian and military member kidnappings and murders in the Middle East received significant international media coverage. As noted in Chapter 4, these types of acts appear to be an increasing method of terrorism.

Hostage Taking

Hostage taking is typically an overt seizure of people to gain publicity for a cause, gain political concessions, political asylum, release of prisoners, or ransom. Many times the terrorists will take hostages with the intent to kill them after they believe they have fully exploited the media coverage from the situation.

Unlike kidnapping where a prominent individual is normally taken and moved to an unknown location, the hostages are usually not well known figures in the enemy's society. While dramatic, hostage situations are frequently risky for the terrorist group, especially when conducted in enemy territory. They expose the terrorists to hostile military or police operations, and carry significant possibility of both mission failure and capture. Therefore,

²⁸³ COL Thomas D. Phillips, "The Dozier Kidnapping: Confronting the Red Brigades," *Air and Space Power Chronicles* (February 2002): 1; available from <http://www.airpower.maxwell.af.mil/airchronicles/cc/phillips.html>; Internet; accessed 31 March 2004.

²⁸⁴ U.S. Marine Corps, Marine Corps University, Corporals Noncommissioned Officers Program, Force Protection, Course CPL 0302, (Quantico, VA, January 1999), 12-13; available from http://www.tecom.usmc.mil/utm/Force_Protection1_LP.PDF; Internet; accessed 31 March 2004.

terrorists will usually attempt to hold hostages in a neutral or friendly area, rather than in enemy territory. Since hostage taking is risky, the benefits must warrant conducting this type operation. For example, if the enemy captures the leader or principal members of the terrorist group, the group may take hostages to exchange for its key personnel.

An excellent example of a hostage situation was the Moscow theater siege in October 2002. Thirty-four Chechen terrorists seized a movie theater, threatening to kill all of the hostages if the Russians did not meet their demands. The rebels were demanding that Russian forces end the war in the breakaway republic of Chechnya. Following a long stalemate, Russian forces assaulted the theater. Sixty-seven hostages died as well as the 34 terrorists. However, 750 hostages were released.

Another example is the hijacking of TWA Flight 847 from Athens to Rome in 1985 by two members of Hizballah. They held the plane and 153 hostages for 17 days demanding the release of Lebanese and Palestinian prisoners. The hostages were released after Israel freed 435 prisoners. However, a U.S. Navy diver, Robert Stethem, was killed and his body was dumped on the tarmac during the ordeal.

Hijacking

Hijacking involves the forceful commandeering of a conveyance. Although normally associated with planes, it can also include naval vessels or other craft. There are many purposes to hijacking, such as hostage taking activities, procuring a means of escape, or as a means of destruction. While hijacking of aircraft for hostage taking has declined in frequency since the implementation of improved security measures, the use of hijacked aircraft for escape or as destructive devices continues and terrorist groups have a significant amount of information on how to conduct hijacking operations. The attacks on the World Trade Center and the Pentagon in September 2001 are vivid reminders of the hijacking abilities of terrorist groups and the destructive power of hijacked airliners.

The use of hijacked vehicles for destructive devices is not restricted to aircraft. Trucks carrying cargoes of explosive or flammable materials have also been seized to use as delivery devices. The possibility of such a technique being used with a ship carrying oil, refined petroleum products, or liquefied natural gas (LNG) is of great concern. The horrific results of several accidental explosions and fires from mishaps in handling such vessels in port show the catastrophic potential of this technique.²⁸⁵ Ships exploding in the harbors of Texas City, Texas in 1947 and Halifax, Nova Scotia in 1917 destroyed significant portions of these towns, and had a combined death toll of over 2500 people.

Raid or Ambush

A terrorist raid is similar in concept to a conventional operation, but is usually conducted with smaller forces against targets marked for destruction, hijacking, or hostage/barricade operations. In these cases, the raid permits control of the target for the execution of some other action. The kidnapping or assassination of a target that has a security force can often

²⁸⁵ Gerald Pawle, *Secret Weapons of World War II* (New York: Ballantine Books, 1967), 53-54.

require a raid to overcome the defenses. Successful execution of these type attacks requires extensive preoperational surveillance and detailed planning.

Examples of this type tactic are the raids conducted by terrorists on three Riyadh western housing compounds in Saudi Arabia on 11 May 2003. Attackers penetrated each compound and then detonated vehicle borne IEDs. The attack at the al-Hamra compound demonstrates the tactics used in a raid such as this. A Toyota sedan pulled up to the gate, followed by a GMC Suburban. A number of terrorists then dismounted, shot the guard, and then forced their way into the compound. As both vehicles drove to the center of the compound, terrorists shot into buildings and at any moving targets. Once they reached the housing area, a suicide terrorist detonated the explosive device in the GMC Suburban.²⁸⁶

An ambush is a surprise attack characterized by violence of execution and speed of action. Terrorists' use of this tactic is similar in concept to conventional military operations. The intended objective may be to cause mass casualties, assassinate an individual, or disrupt hostile security operations. Explosives, such as bombs and directional mines, are a common weapon used in terrorist ambushes. They are powerful and can be remotely detonated. Other weapons frequently used are rocket launchers, automatic weapons, and pistols.

The varieties of firepower and ambush tactics used by terrorists have been repeatedly demonstrated in Iraq during recent years as coalition forces and civilians are attacked. However, this is a common tactic used by terrorist groups around the world. As discussed earlier in this appendix, terrorists in Europe ambushed the motorcades of both General Haig and General Kroesen. However, terrorists do not limit their targets to just prominent individuals. In the Balkans in August 2001, Albanian terrorists ambushed a Macedonian security force convoy using mortars and rocket launchers killing 10 members of the security force.

This tactic is taken one step further in a compound attack. If the unconfirmed threat of a bomb or arson will not generate the desired evacuation, an actual attack can be substituted. Using a standoff weapon such as a rocket launcher or mortar, the attack would be of short duration and need only be effective enough to force an evacuation to the more vulnerable area. If it can be obtained, knowledge of the targets' standard response to various types of attack permits the terrorist to craft a devastating two-step assault.

A relatively recent example of a compound attack was the bombing in Bali on 12 October 2002, attributed to Jemaah Islamiyah, which is an Islamic terrorist group linked to al Qaeda. Initially, an electronically triggered bomb was detonated in a bar that forced the patrons out into the street. The compound attack was completed when a much more powerful car bomb was detonated in the street in front of another establishment. The result was 202 killed and 209 injured.²⁸⁷

Terrorist ambushes are frequently conducted from a variety of mobile platforms. Cars, vans and motorcycles have been used to conceal the attackers, isolate or immobilize the target, and

²⁸⁶ Department of State, U.S. Embassy, Jakarta, Indonesia, *Threats Involving Vehicle Borne Improvised Explosive Devices* (Jakarta, Indonesia, 2003), 2; available from http://www.usembassyjakarta.org/vbied_vehicles.html; Internet; accessed 14 January 2004.

²⁸⁷ *Wikipedia*, 2004 ed., s.v. "2002 Bali Terrorist Bombing;" available from http://en.wikipedia.org/w/wiki.phtml?title=2002_Bali_terrorist_bombing&printable=yes; Internet; accessed 17 March 2004.

then allow the attackers to escape. Ambushes from mobile platforms can be conducted while moving, or can be designed to bring the target to a halt in order to allow the attack team to physically close with and destroy the target. The 1989 assassination of Colonel Rowe in the Philippines described earlier is an example of a mobile ambush, as is the more recent March 2004 attack on five U.S. civilians working for a private volunteer organization (PVO) in Iraq. Four were killed and one was wounded in this mobile ambush in the city of Mosul.

Seizure

Seizure of a critical element of infrastructure, similar to hostage taking intentions, can be a physical site such as a facility of importance to a target population, or a cyber node that disrupts or precludes use of selected cyber functions.

Assassination

An assassination is a deliberate action to kill specific individuals, usually VIPs (political leaders, notable citizens, collaborators, particularly effective officials, etc.), versus the killing of common people, which is considered murder. The terrorist group assassinates or murders people it cannot intimidate, people who have left the group, people who support the “enemy,” or people who have some symbolic significance for the enemy or world community. Terrorist groups often refer to these killings as “punishment” or “justice” as a way of legitimizing them. In 1981, President Anwar Sadat of Egypt was assassinated by fundamentalist Islamics for his support of peace in the Middle East and his relationship with the West. In September 2001, Northern Alliance leader Ahmed Shah Massoud was assassinated in Afghanistan by two suicide bombers, believed to be from al Qaeda, due to his opposition to the Taliban regime and al Qaeda’s presence in Afghanistan.

Many targets of assassination are symbolic and are intended to have great psychological impact on the enemy. For example, assassinating an enemy government official, a successful businessperson, or a prominent cleric can demonstrate the enemy’s inability to protect its own people. Assassinating local representatives of social or civic order, such as teachers, contributes to disorder while demoralizing other members of the local government and discouraging cooperation with them. An excellent example of this is the attempted assassination of Iraq’s most prominent Shiite cleric, Grand Ayatollah Ali al-Sistani in February 2004. This incident was an apparent attempt to create anger in the long oppressed Shiite community and increase the sectarian and ethnic tensions in post-war Iraq. There have also been a number of assassinations of Iraqis who have assumed leadership positions in support of a transition to a democratic government.

Printed training materials and videos from al Qaeda provide guidance on various methods to conduct assassinations, and also details the critical parts of the body to target with each method.²⁸⁸ Assassination methods include remotely detonated bombing, the use of firearms, knives, heavy weaponry such as anti-tank rocket launchers, and poisoning. However, bombings and shootings are the most common methods.

²⁸⁸ Ben Venzke and Aimee Ibrahim, *The al-Qaeda Threat, An Analytical Guide to al-Qaeda’s Tactics & Targets* (Alexandria: Tempest Publishing, 2003), 14.

Extensive target surveillance and reconnaissance of engagement areas are required to select the optimum mode of attack. Although many factors play into the decision, the target's vulnerabilities ultimately determine the method of assassination. For example, a target driving to work along the same route each day may be vulnerable to an emplaced explosive device.²⁸⁹ Such action requires detailed planning, similar to that for a kidnapping. The main difference is that a kidnapping seeks to keep the target alive (at least, initially), while an assassination or murder does not.

Two notable assassination attempts directed against the American military were conducted by the Red Army Faction in Europe. In 1979, they attempted to kill General Alexander Haig when he was the SACEUR using an explosive device planted on his preferred route to the office. The second attempt was against General Frederick Kroesen in 1981 when he was the CINC, USAEUR using small arms and a rocket launcher against his motorcade. In both cases, the terrorists had conducted surveillance and developed detailed plans for the assassination attempts. However, both attempts fortunately failed. In the case of General Haig, his vehicle was traveling faster than expected and the blast barely impacted the rear of his car. In the attack on General Kroesen, the armor and bulletproof glass on his vehicle, combined with an inaccurate rocket detonation, prevented any serious injuries.

Unfortunately terrorists have been successful in some assassination attempts. In April 1989, Communist insurgents from the New People's Army in the Philippines assassinated an American military advisor, Col. James Rowe. He was killed in a moving ambush where small arms fire defeated the protection of his armored official vehicle. This group, which is a DFTO based in the Philippines, was attacking Americans they considered directly linked to the Philippine military campaign being conducted against their group.

Weapons of Mass Destruction or Effect (WMD/E)

Listing a category as weapons of mass destruction or effect acknowledges a broad range of capabilities that specific terrorist groups would like to acquire. Once acquired, this capability would allow for catastrophic results through numerous delivery means. These type weapons include chemical, biological, radiological, nuclear, and high yield explosives.

Aircraft Threats

A significant concern is the attempt by terrorists to shoot down aircraft using some form of man-portable air defense system (MANPADS) or improvising other systems for this use. There are a number of weapons that terrorists can use to down aircraft and they have demonstrated in the past that they can be successful.

Although part of military operations, probably the most notable incident by terrorists/insurgents downing U.S. military aircraft was in Mogadishu, Somalia in 1993. In compliance with United Nations Security Resolution 814, the United States was conducting a raid to capture some of the close supporters of the leader of one of the rival Somali clans, General Mohammed Farah Aideed. During this raid, two UH-60 Blackhawk helicopters were

²⁸⁹ *Encyclopedia of World Terror*, 1997 ed., s.v. "Assassination."

²⁹¹ FM 3-06, *Urban Operations*, 1 June 2003.

shot down using RPGs. The U.S. had underestimated Aided's ability to shoot down its helicopters using this type system. However, he had brought in fundamentalist Islamic soldiers from Sudan, who had experience shooting down Russian helicopters in Afghanistan, to train his men to use RPGs in an air defense role.²⁹¹ Once again, U.S. military forces realized the threat posed by RPGs in an air defense mission in Afghanistan in 2002 when two MH-47 Chinook helicopters were brought down in the Shah-e-Kot area by this same system.

<i>Date</i>	<i>Location</i>	<i>Aircraft</i>	<i>Operator</i>	<i>Outcome</i>
<i>8 Nov 1983</i>	Angola	Boeing 737	Angolan Airlines (TAAG)	Catastrophic: 130 fatalities of 130 people on board.
<i>9 Feb 1984</i>	Angola	Boeing 737	Angolan Airlines (TAAG)	Hull Loss: aircraft overran runway on landing after being struck by a missile at 8,000 feet during climbout. No fatalities with 130 on board.
<i>21 Sep 1984</i>	Afghanistan	DC-10	Ariana Afghan Airlines	Substantial Damage: aircraft was damaged by the missile, including damage to two hydraulic systems, but landed without further damage. No fatalities.
<i>10 Oct 1998</i>	Democratic Republic of Congo	Boeing 727	Congo Airlines	Catastrophic: 41 fatalities of 41 people on board.
<i>19 Nov 2002</i>	Kenya	Boeing 767	Arkia Israeli Airlines	Miss: two SA-7's were fired at the aircraft during climbout, but missed. No fatalities.

Table C-1: Large Civilian Turbojet Aircraft Encounters with Shoulder-Fired Missiles (1978-Present)

The main concern from terrorists; however, is use of shoulder-fired surface-to-air missiles, also known as MANPADs. These systems normally contain an infrared (IR) seeker with the missile providing little opportunity for warning before impact on the target. The Afghan mujahedeen demonstrated MANPADs lethality by destroying 269 Soviet aircraft during the

Soviet Union's war in Afghanistan. Additionally, 56% of the kills and 79% of the Allied aircraft damaged during Desert Storm were through these weapons.²⁹²

These missiles are very affordable by terrorist groups, and they are widely available on the world weapons market. Unclassified estimates range from 5,000 to 150,000 shoulder-fired SAMs are in terrorist hands. Although the range of these estimates varies considerably, it does demonstrate the concern over the proliferation of these type systems. To demonstrate the number of systems in circulation, as of December 2002, coalition forces in Afghanistan had captured over 5,500 shoulder-fired systems from the Taliban and al Qaeda. Some of these included U.S. Stinger and British Blowpipe missiles.²⁹³

Although these weapons have a target engagement range of a few miles, most experts consider aircraft departures and landings as the times when aircraft are most vulnerable to these weapons. Over the past 25 years, 35 civilian aircraft have come under attack from these weapons, resulting in 24 aircraft being shot down and more than 500 deaths. Of these encounters; however, only 5 incidents involved large airliners.²⁹⁴ (See Table C-1). Unclassified estimates reflect between 25 and 30 non-state groups possess these MANPADS systems. The table below depicts the groups that are believed to be in possession of these weapons through the time period 1996 – 2001.²⁹⁵

Group	Location	Missile Type
Armed Islamic Group (GIA)	Algeria	Stinger (c)
Chechen Rebels	Chechnya, Russia	SA-7 (c), Stinger (c), Blowpipe (r)
Democratic Republic of the Congo (DRC) Rebel Forces	Democratic Republic of the Congo	SA-16 (r)
Harkat ul-Ansar (HUA)	Kashmir	SA-7 (c)
Hezbollah	Lebanon	SA-7 (c), QW-1 (r), Stinger (r)
Hizbul Mujahideen (HM)	Kashmir	Stinger (r)
Hutu Militiamen	Rwanda	Unspecified type (r)
Jamaat e Islami	Afghanistan	SA-7 (c), SA-14 (c)
Jumbish-i-Milli	Afghanistan	SA-7 (c)
Khmer Rouge	Thailand/Cambodia	Unspecified type (r)
Kosovo Liberation Army (KLA)	Kosovo	SA-7 (r)
Kurdistan Workers Party (PKK)	Turkey	SA-7 (c), Stinger (c)
Liberation Tigers of Tamil Eelam (LTTE)	Sri Lanka	SA-7 (r), SA-14 (r), Stinger (c), HN-5 (c)
Oromo Liberation Front (OLF)	Ethiopia	Unspecified type (r)
Palestinian Authority (PA)	Palestinian autonomous	SA-7 (r), Stinger (r)

²⁹² "Man Portable Air Defense System (MANPADS)," *Global Security.org* (n.d.): 1; available from <http://www.globalsecurity.org/military/intro/manpads.htm>; Internet; accessed 19 March 2004.

²⁹³ Christopher Bolkcom, et al, *Homeland Security: Protecting Airliners from Terrorist Missiles* (Washington, D.C.: Congressional Research Service Report for Congress, 3 November 2003), 4-7; available from <http://www.fas.org/irp/crs/RL31741.pdf>; Internet; accessed 1 April 2004.

²⁹⁴ *Ibid.*, 7-9.

²⁹⁵ *Ibid.*, 5-6.

	areas and Lebanon	
<i>Popular Front for the Liberation of Palestine – General Command (PFLP-GC)</i>	Palestinian autonomous areas and Lebanon	Unspecified type (r)
<i>Provisional Irish Republican Army (PIRA)</i>	Northern Ireland	SA-7 (c)
<i>Revolutionary Armed Forces of Colombia (FARC)</i>	Colombia	SA-7 (r), SA-4 (r), SA-16 (r), Redeye (r), Stinger (r)
<i>Rwanda Patriotic Front (RPF)</i>	Rwanda	SA-7 (r), SA-16 (r)
<i>Somali National Alliance (SNA)</i>	Somalia	Unspecified types (r)
<i>Al Qaeda/Taliban</i>	Afghanistan	SA-series (c), Stinger (c), Blowpipe (c)
<i>National Liberation Army (ELN)</i>	Colombia	Stinger (r), Unspecified types (r)
<i>National Liberation Army (UCK)</i>	Macedonia	SA-18 (c)
<i>National Union for the Total Independence of Angola (UNITA)</i>	Angola	SA-7 (c), SA-14 (r), SA-16 (r), Stinger (c)
<i>United State WA Army</i>	Myanmar	SA-7 (c), HN-5N (c)
<i>United Somali Congress – Somali Salvation Alliance (USC-SSA)</i>	Somalia	Unspecified types (r)
<i>Note: (c) is possession confirmed through intelligence sources or actual events; (r) is reported but not confirmed.</i>		

Table C-2: Non-State Groups with Shoulder-Fired SAMS (1996-2001)

Maritime Threats

Terrorist attacks against maritime targets are fairly rare and constitute only 2% of all international incidents over the last 30 years.²⁹⁶ However, there is a history of maritime terrorism and maritime authorities worldwide are increasingly anxious about terrorist attacks on both ports and ships. In fact, some intelligence analysts believe that because land-based targets are better protected, terrorists will turn to the maritime infrastructure because they see these as “softer” targets.²⁹⁷

²⁹⁶ Peter Chalk, “Threats to the Maritime Environment: Piracy and Terrorism,” (RAND Stakeholder Consultation, Ispra, Italy 28-30 October 2002): 9.

²⁹⁷ Graham Gerard Ong, “Next Stop, Maritime Terrorism,” *Viewpoints* (12 September 2003): 1; available from <http://www.iseas.edu.sg/viewpoint/ggosep03.pdf>; Internet; accessed 2 April 2004.

Likely operations conducted by maritime terrorism include suicide attacks on commercial and military vessels, and hijacking for the following purposes: (1) carrying out a subsequent suicide attack on a ship or port (2) seeking ransom (3) smuggling weapons and explosives (4) simple piracy.²⁹⁸

Although few terrorist groups have developed a maritime capability, there have been some exceptions, to include the Provisional Irish Republican Army, Abu Sayyaf Group based in the Philippines, various Palestinian groups, al Qaeda, and the Liberation Tigers of Tamil Eelam (LTTE) in Sri Lanka. In fact the LTTE has quite a large maritime capability to include both coastal and deep-water craft and they have developed a reputation of being the best in the world in this arena.²⁹⁹ They reportedly have roughly 3000 trained personnel and between 100-200 surface and underwater vessels, including attack vessels, logistics vessels, fast personnel carriers, suicide craft, and multi-purpose craft. Additionally, they have employed a range of technologies, including suicide stealth craft, mini submarines, and one-man suicide torpedoes.³⁰⁰

Information presented at the Terrorism in the Asia Pacific Conference in September 2002 reported that al Qaeda had obtained a variety of vessels and systems capable of carrying out attacks against ships and seaports. These included mini-sub, human torpedo systems, and divers trained in underwater demolitions. The larger vessels are commercial ships that are used to generate revenue for al Qaeda. However, there is concern that they could be filled with explosives and used as floating bombs to ram into other ships or port facilities.³⁰¹

The International Maritime Organization has warned that liquefied natural gas (LNG) carriers and other ships carrying volatile cargo could be hijacked and used as weapons of mass destruction. In fact a briefing at the Maritime Security Council's annual International Maritime Security Summit in October 2002 stated that a large ship loaded with LNG could result in an explosion equivalent to a .7-megaton nuclear detonation. (The bomb dropped on Hiroshima, Japan was 15-kilotons.)³⁰² The damage this could create if it occurred in a port, such as the Norfolk Naval Base, would be quite substantial.

The best-known maritime terrorist attack against the U.S. military is the attack on the USS *Cole*, which occurred in October 2000. Two suicide bombers in a small explosive laden boat with a platter charge attacked the ship while it was refueling in Aden Harbor, Yemen. The blast, which blew a 40 by 60-foot hole in the side of the USS *Cole*, killed 17 and injured 39 U.S. crewmen. The al Qaeda member who is believed to have planned the attack on the USS *Cole*, Abdulrahim Mohammed Abda Al-Nasheri, was



Figure C-3: USS *Cole*
(Source: U.S. Navy Photo)

²⁹⁸ Ibid., 2.

²⁹⁹ Ibid., 1.

³⁰⁰ Peter Chalk, "Threats to the Maritime Environment: Piracy and Terrorism," (RAND Stakeholder Consultation, Ispra, Italy 28-30 October 2002): 12.

³⁰¹ Bob Newman, "Terrorists Feared to Be Planning Sub-Surface Naval Attacks," *CNS News.com*, 3 December 2002; available from <http://www.cnsnews.com/ForeignBureaus/archive/200212/FOR20021203a.html>; Internet; accessed 19 March 2004.

³⁰² Ibid., 2.

captured in 2002. Reportedly, he has provided information that supports concerns that terrorists plan to conduct additional maritime attacks. He confessed to planning attacks on shipping in the Strait of Gibraltar by using bomb-laden speedboat attacks against U.S. and British warships as they pass through the strait. Fortunately, the Moroccan intelligence service thwarted the plot.³⁰³

Suicide Tactics

Suicide tactics are particular methods of delivering a bomb or conducting an assassination. They are defined as “An act of terror, employing an explosive or incendiary device that requires the death of the perpetrator for successful implementation.”³⁰⁴ It involves an individual wearing or carrying an explosive device into a crowded area or other target and then detonating it, or driving an explosive laden vehicle to a target and then detonating the device.

Suicide attacks are different in concept and execution from “high-risk” operations. In a high-risk mission, the *likely* outcome is the death of the terrorist(s), but mission success does not *require* that the participants die. The plan will allow for possible escape or survival of the participants, no matter how slim the chances. Using suicide as a tactic *requires* the death of the participant(s) in order to succeed.

A suicide bomber constitutes a highly effective precision-guided munition in the immediate tactical sense, but has a much greater impact from psychological considerations and the seemingly unstoppable nature of the weapon/tactic. There is no doubt that a suicide bombing can result in many casualties, cause extensive damage, attract wide media coverage, and usually guarantees that the attack will be carried out at the most appropriate time and place with regards to the circumstances at the target location.

Although a suicide bomber can be a lone terrorist working independently, the use of suicide terrorism as a tactic is normally the result of a conscious decision on the part of the leaders of terrorist organizations to engage this form of attack. It is frequently conducted as a campaign for a specific objective (e.g. withdrawal of foreign troops, interrupting peace negotiations).³⁰⁵ It can often be a sign that a terror group has failed to meet its goals through less extreme measures, and requires the tactical edge, as well as the potential inspiration to its rank and file, that suicide bombing provides.³⁰⁶ It can also indicate a specific operational requirement that can be met in no other way.

Although often associated with Middle Eastern religious groups, these type attacks are not unique to religious terrorist organizations or the Middle East. Both religiously motivated and secular groups have employed this tactic. Individual motivations on the part of the suicide

³⁰³ Michael Richardson, “A Time Bomb for Global Trade: Maritime-related Terrorism in an Age of Weapons of Mass Destruction,” *Viewpoints* (25 February 2004): 8; available from <http://www.iseas.edu.sg/viewpoint/mricsumfeb04.pdf>; Internet; accessed 5 April 2004.

³⁰⁴ Martha Crenshaw, “Suicide Terrorism in Comparative Perspective,” in *Countering Suicide Terrorism* (Herzilya, Israel: The International Policy Institute for Counter Terrorism, The Interdisciplinary Center, 2002), 21.

³⁰⁵ Yoram Schweitzer, “Suicide Terrorism: Development and Main Characteristics,” in *Countering Suicide Terrorism* (Herzilya, Israel: The International Policy Institute for Counter Terrorism, The Interdisciplinary Center, 2002), 85.

³⁰⁶ Ehud Sprinzak, “Rational Fanatics,” *Foreign Policy*, no. 120 (September/October 2000): 66-73.

assets themselves include religious or political convictions, hatred, and being coerced by the terrorist group into the attack. In addition to the Middle East; suicide attacks have been conducted in India, Panama, Algeria, Pakistan, Argentina, Croatia, Turkey, Tanzania, Kenya,³⁰⁷ Chechnya, Russia, and the United States. However, the single most prolific suicidal terrorist group is the Tamil Tigers (LTTE) in Sri Lanka. They are inspired not due to religious reasons, but more by a cultish devotion to their leader, Velupillai Prabhakaran.³⁰⁸

As in any other terrorist operation, extensive pre-operational surveillance and reconnaissance, exhaustive planning, rehearsals, and sufficient resources will be devoted to an operation employing suicide as a tactic.³⁰⁹ Secrecy is critical in success of a suicide mission in order to maintain the element of surprise. As stated earlier in this handbook, suicide bombers are rarely lunatics working alone, but are usually members of a terrorist group that have been recruited, indoctrinated, and trained. The groups write the texts for the videos usually produced and broadcast after the attack, and take pictures that are used for propaganda posters.

Although historically a male-dominated arena, women are becoming more involved in conducting these type operations. In fact women participated in 30 to 40% of the LTTE's nearly 200 suicide bombings in Sri Lanka.³¹⁰ Suicide attacks have also been conducted by Chechnyan and Palestinian women, as well as attacks conducted by women in Iraq, Turkey and Morocco. Additionally an FBI report has expressed concern over the forming of al Qaeda female units.³¹¹

Another trend is the use of teenagers in terrorist attacks. Palestinian teenagers have been involved in attacks against Israel for over three years. In February 2004, three boys, ages 13, 14, and 15 were arrested because they were planning to carry out an attack in the northern Israeli town of Afula. However, use of children and teenagers in suicide attacks became evident on March 16, 2004, when an 11-year-old boy was stopped at an Israeli checkpoint with a bomb in his bag. Although it is believed that the boy was unaware of the bomb, later that month a 14-year-old was stopped at a checkpoint wearing a suicide explosive vest.³¹²

A typical operation involving suicide can require numerous personnel in support, some for extensive periods of time. A specialized suicide operation, such as assassination, might require 60 or more personnel, and sophisticated agent handling techniques. These support personnel are used to provide accommodations, transport, food, clothing and security for the

³⁰⁷ "Suicide Terrorism: a Global Threat," *Jane's Intelligence Review* (October 2000): 1; available from http://www.janes.com/security/international_security/news/usscole/jir001020_1_n.shtml; Internet; accessed 20 January 2004.

³⁰⁸ "Suicide Terrorism," *The Economist* (January 2004): 3; available from <http://quicksitebuilder.cnet.com/supfacts/id396.html>; Internet; accessed 17 March 2004.

³⁰⁹ Rohan Gunaratna, "Suicide Terrorism: a Global Threat," *Jane's Intelligence Review* (20 October 2000): 1-7; available from http://www.janes.com/security/international_security/news/usscole/jir001020_1_n.shtml; Internet; accessed 7 September 2002.

³¹⁰ Clara Beyler, "Messengers of Death – Female Suicide Bombers," *International Policy Institute for Counter-Terrorism* (February 2003): 3; available from <http://www.ict.org.il/articles/articledet.cfm?articleid=470>; Internet; accessed 18 March 2004.

³¹¹ Clara Beyler, "Female Suicide Bombers – An Update," *International Policy Institute for Counter-Terrorism* (March 2004): 1; available from <http://www.ict.org.il/articles/articledet.cfm?articleid=508>; Internet; accessed 31 March 2004.

³¹² Greg Myre, "Palestinian Bomber, 14, Thwarted before Attack," *International Herald Tribune* (March 2004): 1; available from <http://www.iht.com/articles/511745.html>; Internet; accessed 26 March 2004.

bomber until he/she reaches the target. Resident agents also help provide intelligence for the operation and cell members confirm the intelligence.³¹³

The first major suicide bombing that struck at U.S. military forces was Hizballah's attack on the Marine barracks in Lebanon in October 1983 where 241 Americans were killed. Suicide attacks have also been used against coalition forces in Iraq during Operation Iraqi Freedom (OIF). On 27 December 2003, 12 Iraqis and six coalition troops were killed, and 100 Iraqis and 26 coalition troops were wounded when four suicide bombers conducted coordinated attacks in the city of Kabala.³¹⁴ Unfortunately, these type attacks have continued in Iraq, with no sign of relief in the near future.

International Incidents

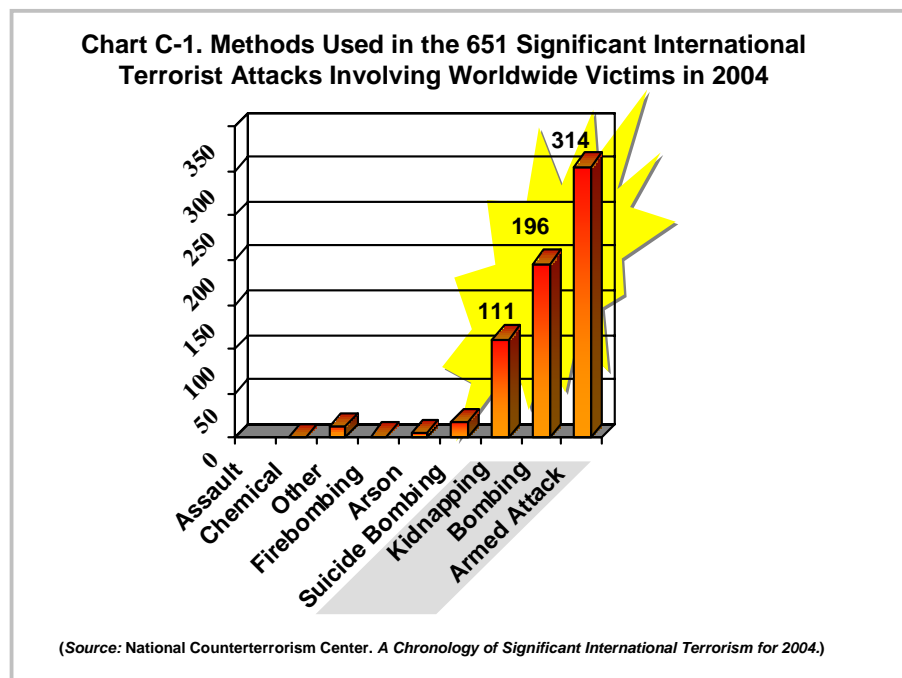

Chart C-1 above, based on data from the National Counterterrorism Center's *A Chronology of Significant International Terrorism for 2004*, illustrates the various types of international terrorist attacks recorded during the year.³¹⁵ Although the categories are somewhat different from this handbook, it does provide a real world representation of the various operations and tactics conducted by terrorists. As displayed in the chart, the most recurring tactic of terrorists

³¹³ "Suicide Terrorism: a Global Threat," *Jane's Intelligence Review* (October 2000): 4-5; available from http://www.janes.com/security/international_security/news/usscole/jir001020_1_n.shtml; Internet; accessed 20 January 2004.

³¹⁴ Tom Lasseter, "Suicide Attackers Strike Karbala," *Knight Ridder*, 27 December 2003; available from http://www.realcities.com/mld/krwashington/news/special_packages/iraq/7581568.htm; Internet; accessed 20 January 2004.

³¹⁵ Department of State, Office for Counterterrorism, *Patterns of Global Terrorism 2003* (Washington, D.C., April 2004, revised 22 June 2004), 5.

are bombing, armed attacks, and kidnapping, with assaults and suicide bombing being the next most frequent methods of operation.

As noted in Chapter 5 of this handbook, the 2004 data analyzed in 2005 cannot be compared to the 2003 information displayed in the 2004 *Patterns of Global Terrorism*. Starting in 2005, the National Counterterrorism Center (NCTC) provides a chronology of international terrorism, *A Chronology of Significant International Terrorism for 2004*, but qualifies that this chronology is not a complete accountability of global terrorist activity. The NCTC also cautions against using incident data alone to gauge success in the War on Terrorism. Criteria for qualifying incidents in this 2005 report have many conditions that include political, religious, philosophical, and cultural motivations; noncombatant definitions; and types of criminal actions that are excluded. Notwithstanding, data in the NCTC report and how terrorist attacks were conducted may include incidents against members of the U.S. Armed Forces, and civilians and police, outside of war zones or warlike settings.

Appendix D Firearms

...an international cabal of terrorists has the firepower to outgun the police of almost every western nation.

How Terrorists Kill: The Complete Terrorist Arsenal by J. David Truby

Terrorists use a variety of weapons to inflict their damage. As explained in the IRA General Headquarters pamphlet, they use explosives and almost any small arms weapon. These weapons can include submachine guns, grenades, pistols, automatic rifles, rifles, mortars, and rocket launchers.³¹⁶ Although some of these appear to be quite sophisticated for terrorists, they have become increasingly more available due to state sponsorship of many terrorist groups, regional conflicts, and a widespread illegal arms trade. In fact, many of the U.S. weapons captured from terrorists have been traced back to Vietnam.

When selecting weapons, terrorists look for 3 major factors: availability, simplicity, and efficiency. They like automatic weapons that can kill from a distance and have stopping power. They also want to be able to conceal the weapon, especially in urban terrain.³¹⁷

As much as possible, terrorists do try to standardize calibers of their weapons for ease of ammunition resupply and they favor easily available military and semi-military weapons.³¹⁸ Most international terrorist groups like full automatic weapons, such as the AK47 and the M16. However, nearly any weapon can be found in use, especially in smaller groups. A favorite weapon by small groups in the United States is the 12-gauge shotgun.

Given the availability of weapons on the black market and the ever-changing technology, there is no way to develop a manual that would show every weapon a terrorist might use. This appendix is organized to review a representative example of various firearms used by terrorists today. It covers five basic types: pistols, submachine guns, assault rifles, sniper rifles, and shotguns.

Pistols are standard weapons for terrorists. They are small so they can be easily concealed. Most of them are lightweight and many modern pistols provide good firepower. Since their effective range is generally limited to about 50 meters, they do limit the distance to engage a target. However, they can be very effective at close range. They are more effective for personal security or victim control than for sustained firefights. Although the revolver is often considered more reliable, the semi-automatic provides more ammunition than a revolver

³¹⁶ Christopher C. Harmon, *Terrorism Today* (London: Frank Cass Publishers, 2000; reprint, Portland: Frank Cass Publishers, 2001), 111.

³¹⁷ Christopher Dobson and Ronald Payne, *The Terrorist: Their Weapons, Leaders, and Tactics* (New York: Facts on File, Inc, Revised Edition, 1982), 104.

³¹⁸ J. David Truby, *How Terrorists Kill: The Complete Terrorist Arsenal* (Boulder: Paladin Press, 1978), 7-8.

that only holds 6 bullets. Additionally, replacing a magazine is much faster than reloading a revolver's cylinder.

Submachine guns are basically short rifles that have a full automatic fire capability. They use pistol-caliber ammunition and typically have large magazine capacities. Their range, accuracy and penetration are better than pistols due to the longer barrel and sight radius. Submachine guns are a favorite with terrorist groups because they are small, light and easily concealed. They provide a large amount of firepower and are deadly at close range.

Assault rifles are the primary offensive weapons of modern militaries and are used extensively by terrorist organizations. In April of 2002, the Israeli Defense Forces seized a number of weapons in the West Bank. In that operation, 1,335 Kalashnikov rifles were recovered.³¹⁹ Assault rifles have calibers ranging from 5.45mm to 7.62mm and magazine capacities often in excess of 30 rounds. They normally have selective firing capability to allow single shot, 2 or 3 round bursts, or full automatic mode. Their effective ranges often exceed 600 meters and have effective rates of fire up to 400 rounds per minute in full automatic mode. When used by terrorists, the terrorist has the same firepower that a modern soldier has on the battlefield.

Since one of the major terror tactics is assassination, sniper weapons are often used to attack targets that are difficult to get close enough for other weapons. Additionally, with the development of large caliber sniper weapons, such as the Armalite AR-50 in .50 Caliber BMG, terrorists can also effectively engage light armored vehicles.

Although limited in range and penetration capability, shotguns are excellent weapons, especially for close-range assassinations or attacks. There is no requirement for precise aim since the dispersion effect of the large number of pellets will cover a wide area. They are readily available and relatively inexpensive compared to other weapons. Additionally, the barrels can be sawed off to permit easy concealment.

³¹⁹ "Weapons of Terror," *ADL* (8 April 2002): 1; available from http://www.adl.org/israel/weapons_list.asp; Internet; accessed 8 January 2003.

Handguns

CZ 75 (Czechoslovakia)

 <p>(Source: MCIA-1110-001-93, <i>Infantry Weapons Identification Guide</i>, September 1992, 94)</p>	<p>Ammunition Types</p> <p>9mm Parabellum</p>	<p>Typical Combat Load</p> <p>Magazine Capacity: 16</p>
<p>SYSTEM</p> <p>A double-action semi-automatic pistol modeled after the Browning P-35. It can be carried cocked and locked and is considered a very accurate handgun. Its design has been copied frequently to produce such guns as the TZ75, EAA Witness, TA90, Springfield Armory P9, ITM AT84, ITM AT88, and Baby Eagle.</p> <p>Weight (kg): 0.98 Length (mm): 203 Operation: Recoil operated double action. Fire Mode: Semi-automatic</p> <p>SIGHTS</p> <p>Iron sights.</p>	<p>VARIANTS</p> <p>CZ 75B, 75BD, 75DAO, 75 Police: available in 9mm Luger, 9x21mm, .40 S&W</p> <p>CZ 75 Compact, 75D Compact, 75 Semi Compact: Available in 9mm Luger.</p> <p>AMMUNITION</p> <p>Name: 9mm Parabellum Caliber/length: 9 x 19 mm Effective Range (m): 50 Muzzle Velocity (m/s): 381</p>	

Glock 17 (Austria)

 <p>(Source: Photograph Courtesy of GLOCK, Inc.)</p>	<p>Ammunition Types</p> <p>9mm Parabellum</p>	<p>Typical Combat Load</p> <p>Magazine Capacity: 10, 17, 19, 31</p>
<p>SYSTEM</p> <p>A semiautomatic handgun originally adopted by the Austrian Army and Police. It has a unique safe action striker-fired trigger mechanism that sets the striker in the half-cocked position after each round. When firing, the shooter pulls the trigger, which disengages the trigger safety, then cocks the striker to the full cock position prior to firing. The Glock has a polymer frame and steel slides.</p> <p>Weight (kg): .905 Length (mm): 186 Operation: Recoil operated double action. Fire Mode: Semiautomatic</p> <p>SIGHTS</p> <p>Iron sights. Adjustable on competition models.</p>	<p>VARIANTS</p> <p>Glock 17L: Competition version Glock 18: 3 round burst version Glock 19: Compact version Glock 34: Competition version Numerous other models in a variety of calibers.</p> <p>AMMUNITION</p> <p>Name: 9 mm Parabellum Caliber/length: 9 x 19mm Effective Range (m): 50 Muzzle Velocity (m/s): 350</p>	

Makarov Pistol (USSR/Russia)

 <p>(Source: U.S. Army Special Forces Foreign Weapons Handbook, January 1967, I-13)</p>	<p>Ammunition Types</p> <p>9mm Makarov</p>	<p>Typical Combat Load</p> <p>Magazine Capacity: 8</p>
<p>SYSTEM</p> <p>A blowback operated, double action semiautomatic handgun that is extremely sturdy, simple to operate and maintain, and very reliable. It was designed for Soviet army officers and Soviet police. It is a Walther PP style weapon and provides good defense at short and medium distances. There are some disadvantages with this weapon, specifically the 9mm Makarov is considered to be underpowered. Additionally, the magazine capacity of 8 is low compared to other handguns available.</p> <p>Weight (kg): .66 Length (mm): 160 Operation: Double action Fire Mode: Semiautomatic</p> <p>SIGHTS</p> <p>Iron sites.</p>	<p>VARIANTS</p> <p>PMM: 9x18mm Izh 71: 9x17mm short/.380 ACP Baikal IJ 70: 9mm Makarov/.380 ACP</p> <p>AMMUNITION</p> <p>Name: 9mm Makarov Caliber/length: 9 x 18mm Effective Range (m): 50 Muzzle Velocity (m/s): 315</p>	

Ruger GP100 (United States)

 <p>(UNCLASSIFIED)</p> <p>(UNCLASSIFIED)</p> <p>Figure 13. (U) Ruger GP100 .357 Magnum Revolver</p> <p>(Source: (S/NF/WN/NC) DST-2660H-481-89, <i>Terrorist Weapons Handbook – Worldwide</i> (U), 15 December 1989, 13. Unclassified Extract.)</p>	<p>Ammunition Types</p> <p>.357 Magnum .38 Special</p>	<p>Typical Combat Load</p> <p>Cylinder Capacity: 6</p>
<p>SYSTEM</p> <p>The Ruger GP100 is a rugged double-action revolver, available in fixed and adjustable sight models. It was designed specifically for the law enforcement and security communities. It can be field stripped very quickly for easy maintenance. Although it is chambered for the .357 Magnum, it can also fire the .38 Special cartridge.</p> <p>Weight (kg): 1.28 Length (mm): 238 Operation: Double action Fire Mode: Single shot</p> <p>SIGHTS Adjustable iron sights.</p>	<p>VARIANTS</p> <p>GP-141 KGP-141 GP-160 KGP-160 GP-161 KGP-161</p> <p>AMMUNITION</p> <p>Name: .357 Magnum Caliber/length: .357 Cal/33 mm Effective Range (m): 60 Muzzle Velocity (m/s): 442</p>	

Submachine Guns

Heckler & Koch MP-5 (Germany)

 <p>(Source: (S/NF/WN/NC) DST-2660H-481-89, <i>Terrorist Weapons Handbook – Worldwide</i> (U), 15 December 1989, 19. Unclassified Extract.)</p>	<p>Ammunition Types</p> <p>9 mm Parabellum</p>	<p>Typical Combat Load</p> <p>Magazine Capacity: 10, 15, 30</p>
<p>SYSTEM</p> <p>A submachine gun with a recoil operated roller-locked bolt that fires from a closed position. Very accurate and reliable under adverse conditions with only a minimum requirement for maintenance. The smooth recoil characteristics provide optimum control when firing bursts or when firing full automatic. It is very conducive for concealed carrying or for use in confined areas.</p> <p>Weight (kg): 3.07 loaded Length (mm): 490/660 Cyclic Rate of fire (rd/min): 800 Operation: Blowback Fire Mode: Semi-automatic, Full automatic</p> <p>SIGHTS</p> <p>Post front, select range peep rear.</p> <p>Night sights, scopes, laser aiming devices available.</p>	<p>VARIANTS</p> <p>MP5A1 – w/o stock MP5A2 – fixed polymer stock MP5A3 – telescopic metal stock SD1 – SD3 – same as above with internal silencers MP5N – US Navy model with 3 round burst capability</p> <p>AMMUNITION</p> <p>Name: 9 mm Parabellum Caliber/length: 9 x 19 mm Effective Range (m): 200 Muzzle Velocity (m/s): 400</p>	

PM 63 (Poland)

 <p>9 mm machine pistol M63</p> <p><i>(Source: USAREUR Pam 30-60-1, Identification Guide, Part One: Weapons and Equipment, East European Communist Armies, Volume 1: General, Ammunition and Infantry Weapons, September 1972, 70)</i></p>	<p>Ammunition Types</p> <p>9 mm Makarov</p>	<p>Typical Combat Load</p> <p>Magazine Capacity: 15, 25</p>
<p>SYSTEM</p> <p>The PM 63 is a blowback operated SMG that fires from the open bolt position. Although it is capable of both semi-automatic and full automatic modes, there is no selector switch. The semi-automatic mode is achieved by a short pull of the trigger, whereas full automatic requires pulling the trigger completely. It was designed with Special Forces in mind and was one of the lightest SMGs when it was introduced. It has been used by Polish Special Forces, police and by military personnel requiring a compact weapon. Iranian terrorists used it during the siege of the Iranian embassy in London in 1980. It has been a very prolific weapon, with tens of thousands being produced.</p> <p>Weight (kg): 2.0 Loaded Length (mm): 333/583 Cyclic Rate of fire (rd/min): 650 Operation: Blowback, firing from open bolt position Fire Mode: Semi-automatic, Full automatic</p> <p>SIGHTS</p> <p>Iron sights that can be set on 75 or 150 meters.</p>	<p>VARIANTS</p> <p>9mm Parabellum developed in 1971.</p> <p>Unlicensed copy by NORINCO of China.</p> <p>AMMUNITION</p> <p>Name: 9mm Makarov Caliber/length: 9 x 18 mm Effective Range (m): 75 Muzzle Velocity (m/s): 320</p>	

Uzi (Israel)

 <p>(Source: (S/NF/WN/NC) DST-2660H-481-89, <i>Terrorist Weapons Handbook – Worldwide</i> (U), 15 December 1989, 20. Unclassified Extract.)</p>	<p>Ammunition Types</p> <p>9mm Parabellum</p>	<p>Typical Combat Load</p> <p>Magazine Capacity: 20, 25, 32</p>
<p>SYSTEM</p> <p>The Uzi is a recoil operated, select fire submachine gun that fires from the open bolt position. It has a folding stock and can be equipped with silencers. The Uzi submachine gun is manufactured by IMI and has been adopted by more than 90 countries for their police and military. Special operations and security units to include the US Secret Service and the Israeli Sayeret (Special Forces) use the compact variants. It is considered one of the most popular SMGs in the world, with more than 10 million manufactured around the world.</p> <p>Weight (kg): 4.0 loaded Length (mm): 470/650 Cyclic Rate of fire (rd/min): 600 Operation: Blowback, firing from open bolt position Fire Mode: Semi-automatic, Full automatic</p> <p>SIGHTS</p> <p>Front – Post; Rear – Aperture “L” Flip. Tactical flashlights and laser aiming modules are available.</p>	<p>VARIANTS</p> <p>Mini Uzi Micro Uzi</p> <p>AMMUNITION</p> <p>Name: 9 mm Parabellum Caliber/length: 9 x 19mm Effective Range (m): 200 Muzzle Velocity (m/s): 400</p>	

Assault Rifles

AK 47 (Russia)

 <p>(Source: OPFOR Worldwide Equipment Guide, TRADOC ADCSINT-Threats, September 2001, 1-4.1)</p>	<p>Ammunition Types</p> <p>7.62 x 39 mm</p>	<p>Typical Combat Load</p> <p>Magazine Capacity: 30</p>
<p>SYSTEM</p> <p>A gas operated, selective fire assault weapon adopted by the Soviet Army in 1949. It came with both a fixed wooden stock and a folding metal stock, the AKS, which was issued to paratroopers and armor units. All of the Kalashnikov assault rifles are very dependable and produce a high volume of fire. They are one of the most prevalent weapons used by terror groups today.</p> <p>Weight (kg): 4.876 loaded Length (mm): 870 Cyclic Rate of fire (rd/min): 600 Operation: Gas operated Fire Mode: Semi-automatic, Full automatic</p> <p>SIGHTS</p> <p>Iron sites.</p>	<p>VARIANTS</p> <p>AKS: short stock AKM: updated version of the AK 47 Clones: Sako/Valmet: Finland Galil: Israel R-4/R-4C: South Africa</p> <p>AMMUNITION</p> <p>Name: 7.62 Caliber/length: 7.62 x 39 mm Effective Range (m): 300 Muzzle Velocity (m/s): 710</p>	

AK 74 (Russia)

 <p>(Source: OPFOR Worldwide Equipment Guide, TRADOC ADCSINT-Threats, September 2001, 1-3)</p>	<p>Ammunition Types</p> <p>5.45 mm</p>	<p>Typical Combat Load</p> <p>Magazine Capacity: 30</p>
<p>SYSTEM</p> <p>A gas operated assault weapon used by the Soviet Army. It is basically an AKM rechambered to fire a 5.45mm round. It has a higher muzzle velocity than the AK 47/AKM, which gives it a longer effective range. It does not have the accuracy of the M16, but reportedly has better reliability in a combat situation and less maintenance requirements than the M16.</p> <p>Weight (kg): 3.6 loaded Length (mm): 933 Cyclic Rate of fire (rd/min): 600 Operation: Gas operated Fire Mode: Semi-automatic, Full automatic</p> <p>SIGHTS</p> <p>Front: Post, Rear: U-notch</p> <p>Night sights are available.</p>	<p>VARIANTS</p> <p>AKS 74: Folding stock version</p> <p>AMMUNITION</p> <p>Name: 5.45mm Caliber/length: 5.45 x 39 mm Effective Range (m): 500 Muzzle Velocity (m/s): 900</p>	

Colt M16 (United States)

 <p>(Source: US Army File Photo)</p>	<p>Ammunition Types</p> <p>5.56mm (.223 Rem)</p>	<p>Typical Combat Load</p> <p>Magazine Capacity: 20, 30</p>
<p>SYSTEM</p> <p>A gas operated automatic assault rifle used by the US military as its primary weapon. Originally developed by Armalite as the AR 15, this was a scaled down version of the AR 10 redesigned to use the .223 Remington cartridge.</p> <p>It has been modified numerous times and is used by nearly 30 different militaries and is very popular with law enforcement agencies.</p> <p>Weight (kg): 2.89 empty Length (mm): 986 Cyclic Rate of fire (rd/min): 800 Operation: Gas operated Fire Mode: Semi-automatic, Full automatic</p> <p>SIGHTS</p> <p>Iron sites. Scope capable.</p>	<p>VARIANTS</p> <p>M16A1, A2, A3: Various upgrades.</p> <p>Civilian clones by Bushmaster, Armalite, Professional Ordnance, and many others.</p> <p>AMMUNITION</p> <p>Name: 5.56 NATO Caliber/length: 5.56 x 45mm Effective Range (m): 460 Muzzle Velocity (m/s): 991</p>	

Sniper Rifles

ArmaLite AR 50 (United States)

 <p>(Source: Photo courtesy of ArmaLite*)</p>	<p>Ammunition Types</p> <p>.50BMG</p>	<p>Typical Combat Load</p> <p>Single Shot</p>
<p>SYSTEM</p> <p>A single shot bolt action rifle that uses the .50 Cal Browning Machine Gun ammunition. It has a unique octagonal receiver bedded into a sectional aluminum stock and has a modified M-16 type pistol grip. The butt stock is fully adjustable and is removable for transport.</p> <p>Weight (kg): 19.24 with scope Length (mm): 1499 Operation: Bolt Action Fire Mode: Single shot</p> <p>SIGHTS</p> <p>ArmaLite sells this with a Leupold Mk4 10-power scope.</p> <p>* ArmaLite is a registered trademark of ArmaLite.</p>	<p>VARIANTS</p> <p>AMMUNITION</p> <p>Name: .50BMG Caliber/length: 12.7x99mm Effective Range (m): 1200 Muzzle Velocity (m/s): 865-890</p>	

Remington Model 700 (United States)

	<p>Ammunition Types</p> <p>.223 Rem .308 Win</p>	<p>Typical Combat Load</p> <p>Magazine Capacity: 5</p>
<p>(Source: US Army File Photo)</p>		
<p>SYSTEM</p> <p>A bolt action, magazine fed rifle that is basically a restocked Remington Model 700 VS varmint rifle. This is one of the most widely used tactical rifles in the United States. The police, the US Army and the US Marine Corps, use it.</p> <p>Weight (kg): 4.08 empty without scope Length (mm): 1662 Operation: Bolt Action Fire Mode: Single Shot</p> <p>SIGHTS</p> <p>Variable telescopic scopes. No iron sights.</p>	<p>VARIANTS</p> <p>M24 Sniper Weapon System (US Army) M40A1 Sniper Rifle (USMC)</p> <p>AMMUNITION</p> <p>Name: .223 Rem/.308 Win Caliber/length: 5.56x45mm / 7.62x51mm Effective Range (m): 800 Muzzle Velocity (m/s): 1005 / 780-840</p>	

Steyr-Mannlicher SSG-69 (Austria)

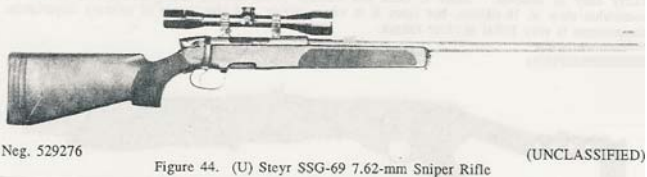
 <p>(Source: (S/NF/WN/NC) DST-2660H-481-89, <i>Terrorist Weapons Handbook – Worldwide</i> (U), 15 December 1989, 32-33. Unclassified Extract.)</p>	<p>Ammunition Types</p> <p>7.62 x 51mm (.308 Win)</p>	<p>Typical Combat Load</p> <p>Magazine. Capacity: 5</p>
<p>SYSTEM</p> <p>A bolt action, magazine fed rifle, which has been used as a sniper rifle by the Austrian forces, as well as many police agencies. The rifle is extremely accurate and has been used to win a number of international competitions.</p> <p>Weight (kg): 4.6 with scope. Length (mm): 1130 Operation: Bolt Action Fire Mode: Single shot</p> <p>SIGHTS</p> <p>Scope</p>	<p>VARIANTS</p> <p>AMMUNITION</p> <p>Name: .308 Win Caliber/length: 7.62 x 51mm Effective Range (m): 800 Muzzle Velocity (m/s): 799 - 860</p>	

Shotguns

Franchi SPAS 12 (Italy)

 <p>(Source: (S/NF/WN/NC) DST-2660H-481-89, <i>Terrorist Weapons Handbook – Worldwide</i> (U), 15 December 1989, 34. Unclassified Extract.)</p>	<p>Ammunition Types</p> <p>12 Ga. Shot 12 Ga. Buckshot 12 Ga. Slug</p>	<p>Typical Combat Load</p> <p>Tubular Magazine capacity: 8</p>
<p>SYSTEM</p> <p>This is a dual mode shotgun, which can be operated both as a pump-action style shotgun and as a semi-auto shotgun. It can rapidly fire full power loads such as buckshot set on semi-auto, and can be switched to pump to handle low power rounds -- or if auto functioning fails to function properly. It has a relatively short barrel, which makes it suitable for operation in tight quarters. Both military and the police use it.</p> <p>Weight (kg): 4.0 Length (mm): 1070 Operation: Pump or gas operated Fire Mode: Semi-automatic</p> <p>SIGHTS</p> <p>Iron Blade</p>	<p>VARIANTS</p> <p>AMMUNITION</p> <p>Name: 12 Gauge Caliber/length: 12 Ga/ 2 ¾ inch Effective Range (m): 60 Muzzle Velocity (m/s): 393 (00 Buckshot)</p>	

Mossberg Model 500 (United States)

<p>(UNCLASSIFIED)</p>  <p>(UNCLASSIFIED)</p> <p>Figure 47. (U) Mossberg Model 500 12-Gauge Shotgun</p> <p>(Source: (S/NF/WN/NC) DST-2660H-481-89, <i>Terrorist Weapons Handbook – Worldwide</i> (U), 15 December 1989, 34. Unclassified Extract.)</p>	<p>Ammunition Types</p> <p>12 Ga. Shot 12 Ga. Buckshot 12 Ga. Slug</p>	<p>Typical Combat Load</p> <p>Tubular Magazine capacity: 6, 8, 9</p>
<p>SYSTEM</p> <p>This is a pump action shotgun that is common with the military and police departments, and is sold widely on the commercial market. It is available with both a traditional wood stock and with the pistol grip, as shown above.</p> <p>Weight (kg): 2.6 Length (mm): 711 Operation: Pump Action Fire Mode: Single shot</p> <p>SIGHTS</p> <p>Fixed iron sights</p>	<p>VARIANTS</p> <p>Numerous variations of this model exist.</p> <p>AMMUNITION</p> <p>Name: 12 Gauge Caliber/length: 12 Ga/ 2 ¾ inch and 3 inch Effective Range (m): 60 Muzzle Velocity (m/s): 393 (00 Buckshot)</p>	

Page Intentionally Blank

Appendix E

Improvised Explosive Devices

Shampoo bottles, bicycle seats, tiffins [drinking/eating container]. A plastic container or a LPG cylinder. A parcel of books. A clock, a teddy bear. In the Kashmir Valley, any one of these innocuous objects can be fatal. They are all commonly used by militants to fashion bombs and improvised explosive devices (IEDs). But the most lethal of all is the remote controlled explosive device, hidden in a ditch, a drainpipe or a parked vehicle.

“Lethal Weapons”, *Indian Express Newspaper* (Bombay), August 24, 2000

General

While terrorists will use conventional weapons, such as rocket-propelled grenades and assault rifles to achieve their goals, they also have the ability to assemble and employ a wide variety of lethal improvised explosive devices (IEDs). Explosives are a popular weapon with terrorists and are covered in the al Qaeda training manual. The manual states, “Explosives are believed to be the safest weapon for the Mujahideen. Using explosives allows them to get away from enemy personnel and to avoid being arrested.” It goes on to say that, “In addition, explosives strike the enemy with sheer terror and fright.”³²⁰

IEDs are a common tool of terror used by non-state actors. These devices have been fabricated in an improvised manner and incorporate highly destructive lethal and dangerous explosives or incendiary chemicals, which are designed to kill or destroy the target. The materials required for these devices are often stolen or misappropriated from military or commercial blasting supplies, or made from fertilizer and other readily available household ingredients.³²¹ IEDs basically include some type of explosive, fuse, detonators and wires, shrapnel and pieces of metal, and a container to pack the explosives and shrapnel.

The use of IEDs by terrorists is a constant threat. Terrorist groups are continuously developing new techniques and tactics in response to defenses and countermeasures established by their opponents. They will disguise IEDs to hinder recognition and will often booby-trap the devices to detonate if disturbed.

The most simple of the IEDs used is the one initiated by closing of a battery circuit, similar to turning on a battery operated light. When turning on the switch closes the circuit, electricity flows to the light so it can be illuminated. As shown in Figure E-1, a clothespin-triggering device in this IED replaces the light switch and when it is activated, the electricity flows to the charge, thus detonating the explosive.

³²⁰ Ben N. Venzke and Aimee Ibrahim, *Al Qaeda Tactic/Target Brief* (Alexandria: IntelCenter/Tempest Publishing, 2002), 11.

³²¹ *Conventional Terrorist Weapons* (New York: United Nations Office for Drug Control and Crime Prevention, 2002), 4; available from http://www.undcp.org/odccp/terrorism_weapons_conventional.html; Internet; accessed 12 November 2002.

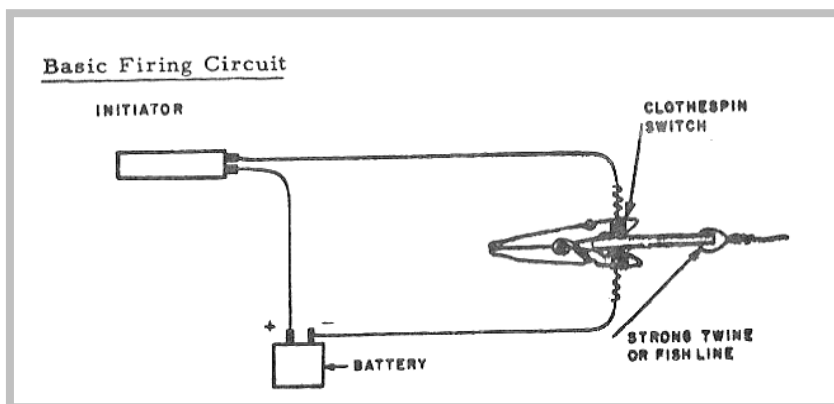

Figure E-1. Basic Firing Circuit (Source: TM 31-210)

The IED can be detonated using a number of triggering devices. These can be mechanical, electrical, or remote controlled type devices. For instance, after emplacing the IED, such as in a natural culvert or under a road by digging and then camouflaging the spot, the terrorist waits for the target to arrive. Once the target is within the damage area, the IED is initiated. The damage caused can be phenomenal as even a small amount of explosive can cause an explosion that dislodges a vehicle up to 50 feet in the air, or damage a bridge totally. This same scenario can be applied to a passenger train. More sophisticated assemblies of IEDs can be even more devastating and cause much damage.

Explosive Charges

Although terrorists use manufactured explosive material, it is easy for them to obtain the ingredients required to make improvised explosive material as well. The ingredients can be purchased at local stores with relative ease. Additionally, the instructions for making these type explosives have been published in a wide variety of literature, such as *The Anarchists Cookbook*,³²² for years. They are also available on the Internet. One such site has the recipes to make 27 different low and high order explosives³²³ and another site gives instructions for both producing explosives and making the bombs.³²⁴ The following are examples of common types of explosive charges found in IEDs.

- Improvised explosive mixtures: Although there are recipes to make virtually any explosive, the following are some common improvised ones that are used.

Ammonium nitrate fertilizer

Black powder

Gasoline

Match heads

Smokeless powder

³²² William Powell, *The Anarchist Cookbook* (Secaucus, NJ: Lyle Stuart, Inc., 1971), 111.

³²³ *Improvised Explosives*; available from http://members.odinsrage.com/white88/18_ImprovisedExplosives.htm; Internet; accessed 11 December 2002.

³²⁴ *Improvised Explosives*, vol. I, version 2.0 (15 May 1990); available from <http://www.logicsouth.com/~lcoble/password/firearms.html>; Internet; accessed 11 December 2002.

Sodium Chlorate and sugar

Chemical reactions:

Acid bombs, such as nitric and sulfuric acid

Caustic bombs, such as Drano toilet bowl cleaner

Dry ice

- Plastic Explosives: This has become the explosive of choice for various international terrorist groups. There are 2 main types used by terrorists:

C-4: a white, RDX based explosive produced by the United States. This is the common plastic explosive used by the U.S. military.

SEMTEX: an orange, RDX and PETN based explosive produced in the Czech Republic. Intelligence experts estimated the bomb that destroyed Pan Am Flight 103 over Lockerbie, Scotland, in 1988 used about two-thirds pound of Semtex.³²⁵

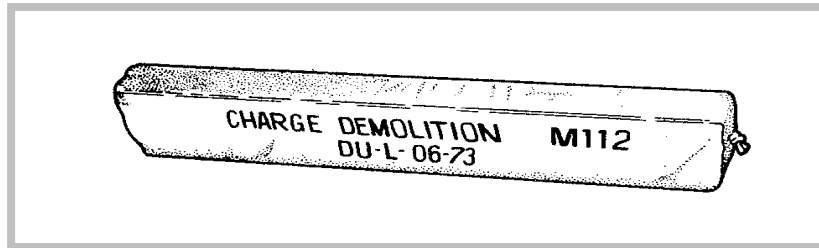

Figure E-2. U.S. Army M112 Block Demolition Charge of C4 (Source: FM 5-25)

- TNT: TNT is a most common military explosive, is used alone or as part of a composite explosive, and is a standard against which other military high explosives are rated.

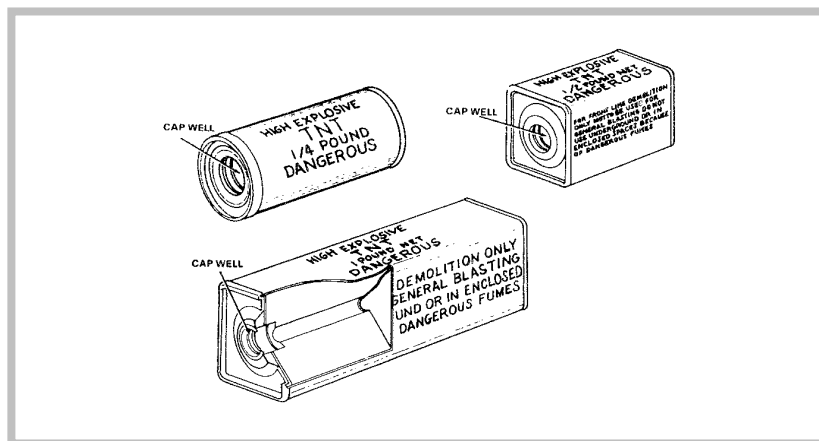

Figure E-3: TNT Block Demolition Charges (Source: FM 5-25)

- Dynamite: The most widely used explosive in the world for blasting operations. It has been fairly easy to obtain by both theft and legal purchases in the past.

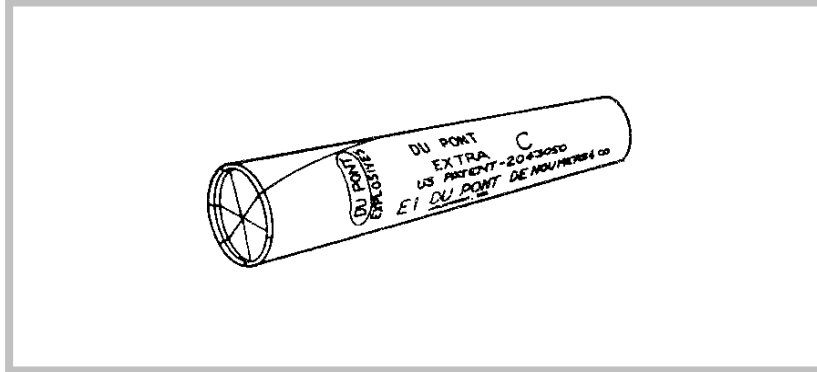

Figure E-4. Commercial Dynamite (Source: FM 5-25)

Common Trigger Devices

As mentioned earlier, some form of trigger is used to detonate the explosive device. These range from very simple homemade devices to highly technical devices. Although not all-inclusive, some examples are listed below.

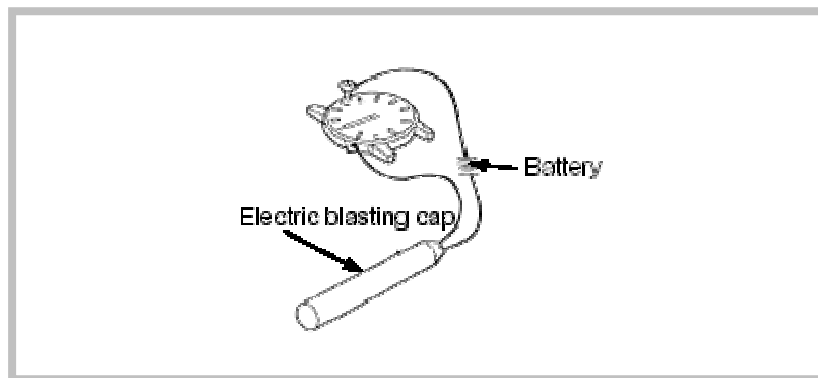

Figure E-5. Wristwatch Device (Source: FM 20-32)

- Manual wind-up alarm clocks and wristwatches. Delay can be up to 24 hours.

³²⁵ Earl Lane, "Plastic Explosives Difficult to Detect," *Newsday.com*, 23 July 1996, 1; available from <http://www.newsday.com/news/nytwa96-jet3bomb.0.2501618.story>; Internet; accessed 12 December 2002.

- Pressure release switch that is spring-loaded. These can be as simple as a mousetrap or a commercially produced switch.

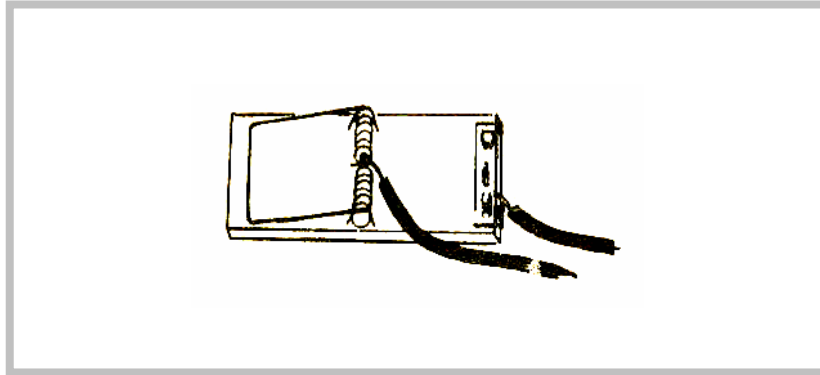

Figure E-6. Mousetrap Switch (Source: TM 31-210)

- Pull switches that actuate when a trip wire is pulled. There are many different forms of these triggers. They can be made easily by stripping the insulation off of wire and looping them together or by inserting a piece of wood between the contact wires on a clothespin.



Figure E-7. Pull-Loop Switch (Source: TM 31-210)

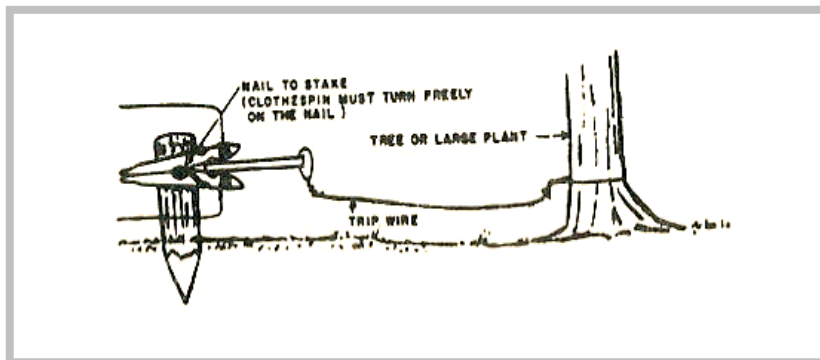

Figure E-8. Clothespin Switch (Source: TM 31-210)

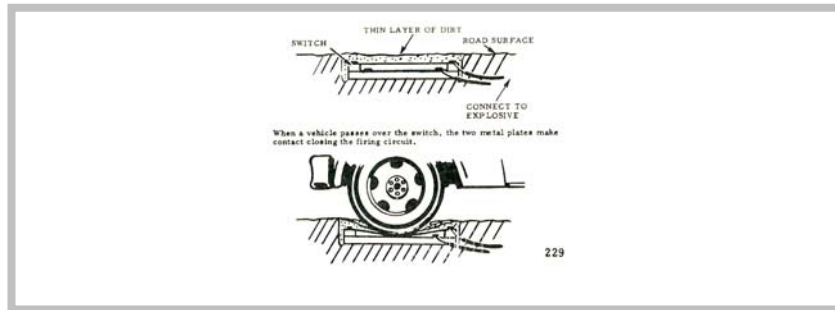

Figure E-9. Pressure Switch (Source: TM 31-210)

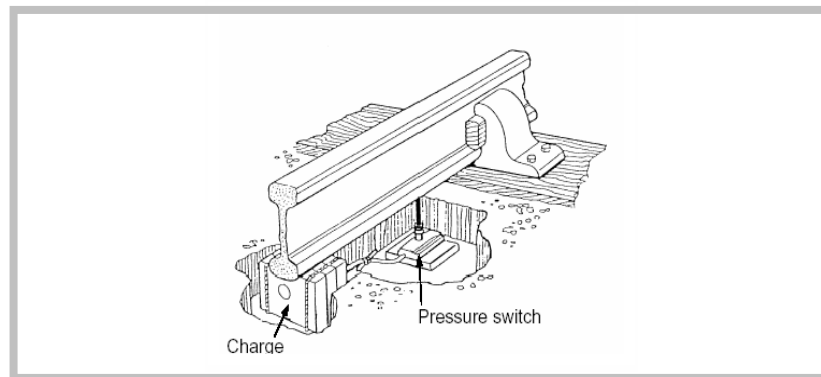

Figure E-10. Pressure Switch (Source: FM 20-32)

- Pressure switches that actuate when weight is applied.
- Metal Ball Switch: This switch will activate the device when it is tipped. It also can be used as an anti-disturbance type system that actuates the explosive device when it is disturbed.

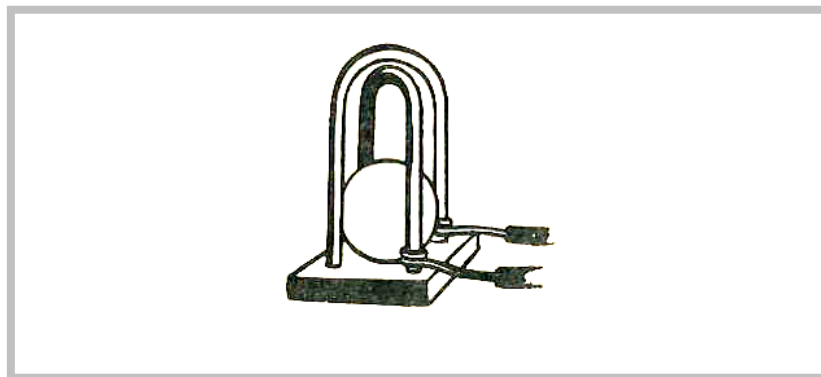

Figure E-11. Metal Ball Switch (Source: TM 31-210)

- Barometric Sensor: Bombs can be triggered using a barometric sensor that detonates once it reaches a specific altitude. The bomb on Pan Am Flight 103 had a detonator with a barometric sensor with a timer delay and triggered only after the aircraft had reached a specific altitude and flew at that altitude for a set length of time.³²⁶

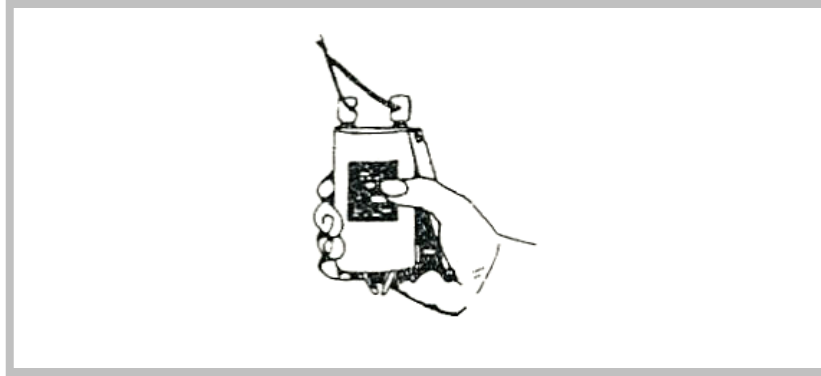

Figure E-12. Hand-held Detonation Device (Source: FM 20-32)

- Wire command detonation.
- Alarm equipment, such as motion detectors, infrared detectors, and heat detectors. Trigger devices were found in Chechnya that could discern the body heat of a person from background clutter over 20 feet away.³²⁷
- LED digital wristwatch.³²⁸
- Radio control systems similar to those used for models. These have been used by the IRA to detonate bombs against the British.³²⁹
- Hand-held radar guns.³³⁰
- Radio command detonation, such as battery-powered garage door openers, cell phones, and paging systems.³³¹

³²⁶ Christopher Wain, "Lessons from Lockerbie," *BBC News*, 21 December 1998, 1; available from http://news.bbc.co.uk/1/hi/special_report/1998/12/98/lockerbie/235632.stm; Internet; accessed 12 December 2002.

³²⁷ Ed Wagamon, "Tactical Combat in Chechnya: Mines & Booby Traps: The Number One Killer" (Part 1 of 2), *How They Fight: Armies of the World*, NGIC-1122-0062-01, vol 4-01 (August 2001): 35.

³²⁸ *Ibid.*, 35.

³²⁹ Bruce Hoffman, *Inside Terrorism* (New York: Columbia University Press, 1998), 180.

³³⁰ *Ibid.*, 181.

³³¹ Ed Wagamon, "Tactical Combat in Chechnya: Mines & Booby Traps: The Number One Killer" (Part 1 of 2), *How They Fight: Armies of the World*, NGIC-1122-0062-01, vol 4-01 (August 2001): 34.

Types of IEDs

The different types of IEDs vary based on the type explosive used, method of assembly, and also the method of detonation. As this is restricted only by human ingenuity, the types of IEDs are infinite. The Technical Support Working Group, which is an interagency group focusing on counter terrorism, categorizes IEDs based on their size and explosive capacity. The following table from *Jane’s Unconventional Weapons Response Handbook* shows the categories.

Threat	Explosives Capacity (TNT Equivalent)
<i>Firebomb or incendiary device</i>	Less than 1 lb (0.5 kg)
<i>Postal explosive device</i>	1-5 lb (0.5 – 2.5 kg)
<i>Pipe bomb</i>	1-5 lb (0.5 – 2.5 kg)
<i>Man-portable explosive device</i>	5-50 lb (2.5 - 25 kg)
<i>Compact sedan</i>	500 lb (225 kg)
<i>Full-size sedan</i>	1,000 lb (455 kg)
<i>Passenger or cargo van</i>	4,000 lb (1,815 kg)
<i>Small moving van or delivery truck</i>	10,000 lb (4,535 kg)
<i>Large moving van or water truck</i>	30,000 lb (13,605 kg)
<i>Semi-trailer</i>	60,000 lb (27,210 kg)
<i>Source: John P. Sullivan, et al., Jane’s Unconventional Weapons Response Handbook (Alexandria, VA: Jane’s Information Group, 2002), 53.</i>	

Table E-1. Explosive Capacity

Although not all inclusive, some of the common IEDs a military organization will encounter are shown below:



Figure E-13. Pipe Bomb (Source: BATF)

- Pipe Bombs. This is a common type of terrorist bomb. Steel, iron, aluminum or copper pipes that are widely available in the market are used and low-velocity explosives are tightly capped inside. These are often wrapped with nails to cause more damage.

Incendiary Devices. The Molotov cocktail was initially used by the Russian resistance against German armored vehicles in WWII. They are very easy to make, yet cause severe damage. The device normally consists of a glass bottle, which contains a very volatile fuel, such as gasoline or diesel. A cloth fuse is inserted through the bottle opening and is ignited before the bottle is thrown at the target.

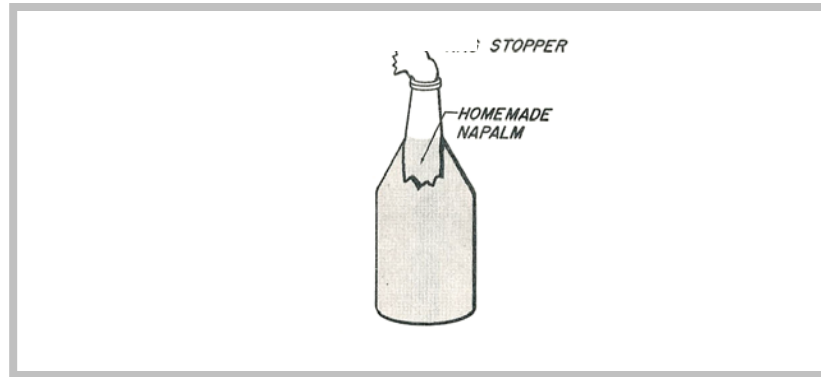

Figure E-14. Molotov Cocktail (Source: TM 31-201-1)

- **Vehicle Devices.** In addition to the IEDs, a vehicle can be modified to conceal and deliver large quantities of explosives to a target. The motive behind such incidents is to cause many casualties and gross property damage. This type of weapon is termed a VBIED (vehicle borne improvised explosive device). Factors encouraging VBIED use include:
 - Mobility.
 - Benign, non-threatening means of delivery and concealment.
 - Capacity to conceal large quantities of explosives.
 - Fragmentation and blast enhancement.
 - Penetration of target's perimeter not required (within reason).
 - Minimal technology, logistics, and financing are needed to assemble a large explosive device proven to cause major personnel casualties and gross property damage.
 - Suicide driver is nearly impossible to stop.

Such devices can also be remotely controlled for detonation. The near-simultaneous use of multiple VBIEDs against geographically dispersed targets has the potential to create mass casualties and panic.

- Other devices: The design of IEDs is only limited to the ingenuity of the person making them. A few examples of other type devices are shown in the accompanying illustrations.



Figure E-15. Dynamite/Nail Bomb (Source: BATF)

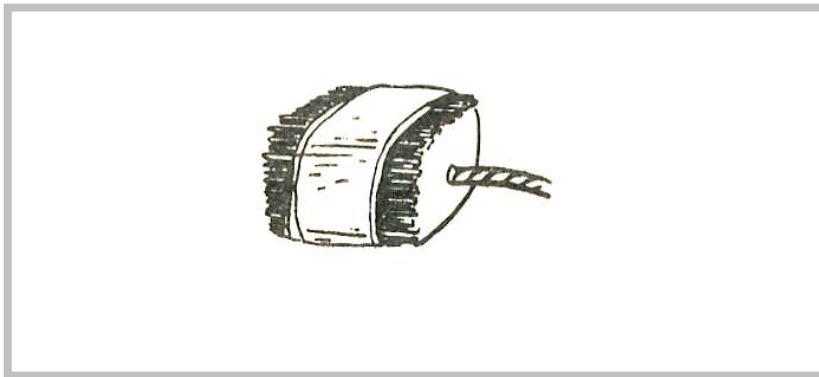

Figure E-16. Nail Grenade (Source: TM 31-210)

- Projected IEDs. These are improvised devices that launch some form of projectile at the intended target. These fall into 3 categories: Explosively formed projectiles (commonly called platter charges or disk charges); shoulder fired rocket launchers; and improvised mortars.

Platter charges. These are designed with some form of explosive material placed on one side of a flat metal plate. When the device is detonated, the metal plate is launched at the target and can penetrate armor and concrete.

Shoulder fired rockets. These are very similar to military rocket launchers, such as the RPG. However, they are less accurate and have a shorter range.

Red Army Brigade Ambush Alfred Herrhausen, 30 November 1989

The Red Army Brigade, primarily a German domestic terrorist group, targeted politicians and influential businessmen for murder. As head of Deutsche Bank, Germany's largest bank, Alfred Herrhausen was the most influential businessman in the country. The Red Army Brigade vowed to kill Herrhausen by the end of November 1989

Herrhausen was chauffeured to work each morning in an armored Mercedes, with bodyguards in a lead and a follow car. The Red Army Brigade learned his routine, which was to take substantially the same route to and from work at approximately the same time each day. That route went through a park, which made for an excellent surveillance and attack site. RAB members, in workers' clothes, dug a small hole across the road, set up an infrared beam on one side and a reflector on the other.

On 30 November 1989, Alfred Herrhausen headed for work in his usual motorcade, along his usual route, at his usual time. A RAB lookout signaled the triggerman that Herrhausen's motorcade was approaching the kill zone. The triggerman allowed the first car through, then activated the infrared beam. When Herrhausen's car broke the beam, a timer delay caused a plate charge hidden on the back of a bicycle to detonate, sending it through the rear door of Herrhausen's armored car. It severed his legs and he bled to death.

The plate charge was driven by 10 kilos (22 pounds) of TNT. It was a 5-pound, 8-inch copper plate. The TNT detonated at 18,000 feet per second, sending the plate into Herrhausen's body at 14,000 feet per second and demolishing the Mercedes.

Source: Diplomatic Security Surveillance Detection Program Course of Instruction, U.S. State Department, October 1999.

Improvised mortars. A mortar system can use propane cylinders as the launch tube; add a simple elevation system and detonator and an improvised mortar system can be obtained.



Figure E-17. Improvised Mortar System (*Source:* File Photo)

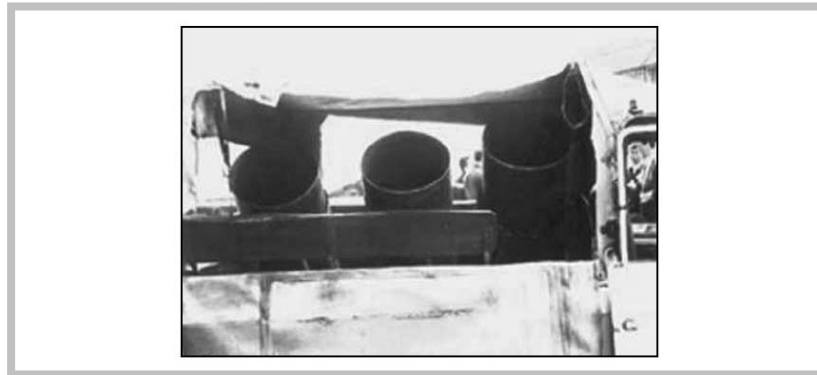

Figure E-18. Multi-tube Battery Mounted in Truck (Source: File Photo)

Commercial Product Modification

Terrorists also show great skill and creativity in their ability to weaponize commercial off the shelf products. Given the right components, something as benign as a cell phone can be turned into a weapon that becomes easy to conceal and to employ. In Figure E-19, the cell phone has been converted to a four-barreled gun.



Figure E-19. Four-barreled Cell Phone Gun (Source: File Photo)

Covert Firearms

Covert firearms can be developed or secretly obtained through black market channels. With the right amount of cash and good connections a terrorist can find or produce many dangerous and unexpected weapons for their arsenals of terror.

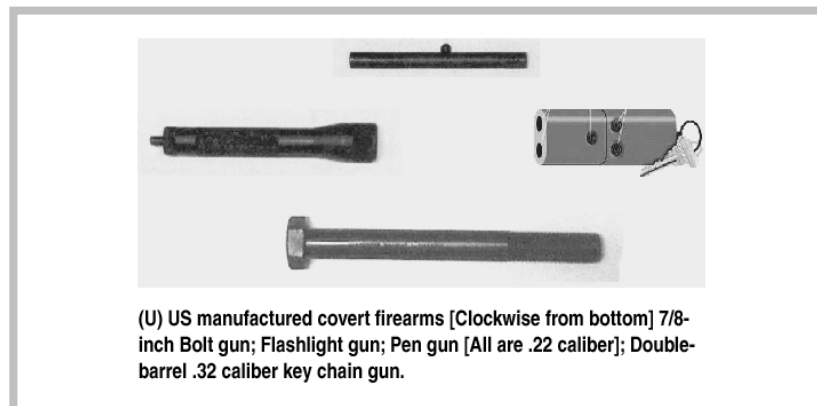

Figure E-20. US Manufactured Covert Firearms (Source: File Photo)

Evacuation Distance Tables

There is no question that U.S. forces are susceptible to the threat posed by IEDs. When confronted with these type devices, trained personnel should only disable them. Friendly personnel should be evacuated to a safe distance to preclude casualties in case the IED is detonated. There are numerous references available covering the IED threat. Figure E-21 is an example of IED smart cards developed by CJTF-7 during OIF and Figure E-22 is an example of a reference guide developed by the Marine Corps. The Army also has GTA 90-01-001, Improvised Explosive Device (IED) and Vehicular Borne Improvised Explosive Device (VBIED) Smart Card, but this has restricted distribution. Table E-2 is representative of a card distributed by the Department of Defense that provides recommended evacuation distances based on the type IED.

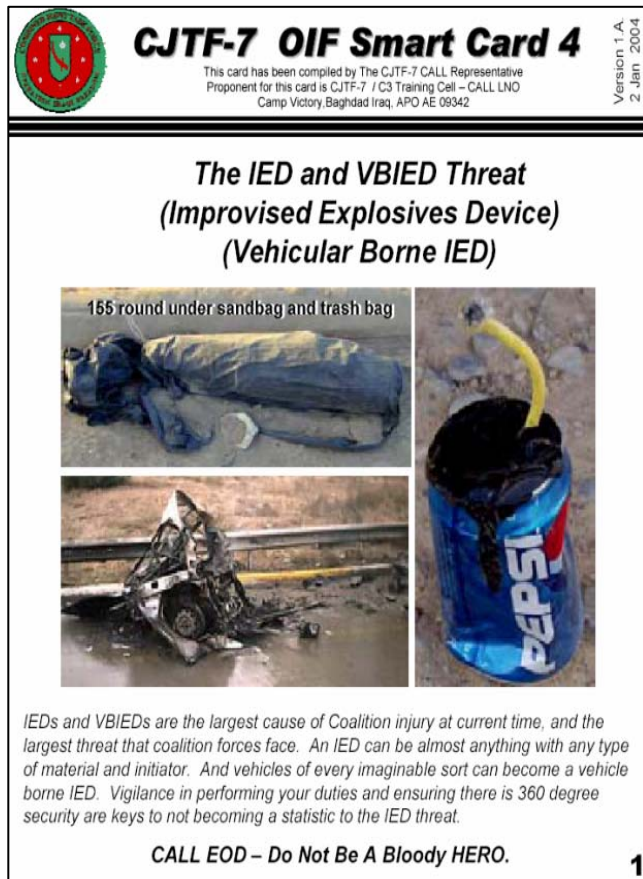

Figure E-21. CJTF-7 OIF Smart Card 4

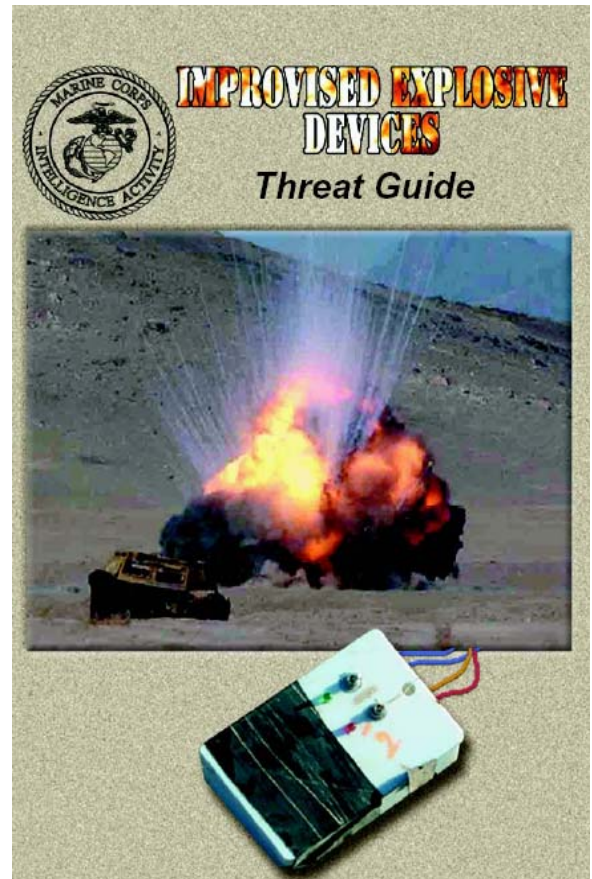

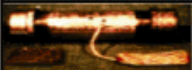









Figure E-24. Marine Corps Intelligence Agency IED Threat Guide

Terrorist Bomb Threat Stand-Off

	THREAT	THREAT DESCRIPTION	EXPLOSIVES CAPACITY ¹ (TNT EQUIVALENT)	BUILDING EVACUATION DISTANCE ²	OUTDOOR EVACUATION DISTANCE ³
		PIPE BOMB	5 LBS/ 2.3 KG	70 FT/ 21 M	850 FT/ 259 M
		BRIEFCASE/ SUITCASE BOMB	50 LBS/ 23 KG	150 FT/ 46 M	1,850 FT/ 564 M
		COMPACT SEDAN	500 LBS/ 227 KG	320 FT/ 98 M	1,500 FT/ 457 M
		SEDAN	1,000 LBS/ 454 KG	400 FT/ 122 M	1,750 FT/ 534 M
		PASSENGER/ CARGO VAN	4,000 LBS/ 1,814 KG	640 FT/ 195 M	2,750 FT/ 838 M
		SMALL MOVING VAN/DELIVERY TRUCK	10,000 LBS/ 4,536 KG	860 FT/ 263 M	3,750 FT/ 1,143 M

This card supersedes any previous undated versions 11/99

Terrorist Bomb Threat Stand-Off

	THREAT	THREAT DESCRIPTION	EXPLOSIVES CAPACITY ¹ (TNT EQUIVALENT)	BUILDING EVACUATION DISTANCE ²	OUTDOOR EVACUATION DISTANCE ³
		MOVING VAN/ WATER TRUCK	30,000 LBS/ 13,608 KG	1,240 FT/ 375M	6,500 FT/ 1,982 M
		SEMI-TRAILER	60,000 LBS/ 27,216 KG	1,570 FT/ 475 M	7,000 FT/ 2,134 M

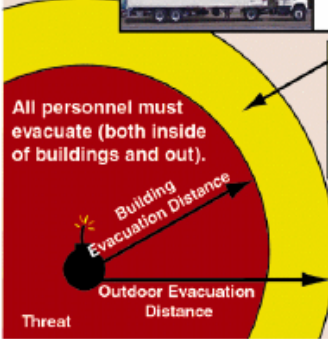

All personnel must either seek shelter inside a building (with some risk) away from windows and exterior walls, or move beyond the Outdoor Evacuation Distance.

Preferred area (beyond this line) for evacuation of people in buildings and mandatory for people outdoors.

¹ Based on maximum volume or weight of explosive (TNT equivalent) that could reasonably fit in a suitcase or vehicle.

² Governed by the ability of an unstrengthened building to withstand severe damage or collapse.

³ Governed by the greater of fragment throw distance or glass breakage/falling glass hazard distance. Note that pipe and briefcase bombs assume cased charges which throw fragments farther than vehicle bombs.

Table E-2. Explosive Device Evacuation Distances (Source: DOD)

Appendix F

Conventional Military Munitions

The regional operational headquarters further disclosed that over the past 24 hours, 19 items of small arms, 9 grenade launchers, 3 machine guns and a large amount of ammunition, including 10 artillery shells and 18 landmines, have been found and seized in Chechnya. Also, over 83 kg of TNT has been found.

“ARMS CACHE FOUND IN GROZNY CEMETERY,” *On-Line Pravda*, 10 August 2002

General

Although terrorists are known for using fabricated improvised explosive devices, they also use a wide variety of military conventional weapons. These weapons range all the way from highly sophisticated Stinger Missiles to booby-trapped unexploded ordnance. This appendix will review many of the weapons the military may encounter when dealing with the terrorist threat.

Fragmentation Grenades

Grenades are a common weapon used by terrorists. In fact, in the annual report published by HAMAS on terrorist activities in 1998, they stated that a combination of time delayed bombs coupled with commando attacks using hand grenades were the major part of effective operations and caused the most casualties.³³² Although terrorists will use any grenade they can acquire, some of the common grenades available are listed below. These figures are courtesy of the Naval Explosive Ordnance Disposal Technology Division.³³³

- Figure F-1. U.S. Grenade, Fragmentation, M2A1, M2A2, U.S. Army

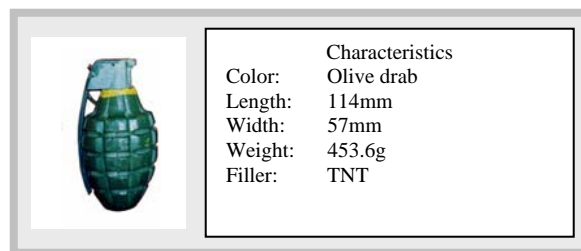

³³² Reuven Paz, *Hamas Publishes Annual Report on Terrorist Activity for 1998* (Herzliya, Israel: International Policy Institute for Counterterrorism, May 3, 1999), 1; available from <http://www.ict.org.il/spotlight/det.cfm?id=259>; Internet; accessed 6 December 2002.

³³³ Department of Defense, Naval Explosive Ordnance Disposal Technology Division, *ORDATA II - Enhanced Deminers' Guide to UXO Identification, Recovery, and Disposal*, Version 1.0, [CD-ROM], (Indian Head, MD: Naval Explosive Ordnance Disposal Technology Division, 1999).

- Figure F-2. U.S. Grenade, Fragmentation, M26, M26A1, M61

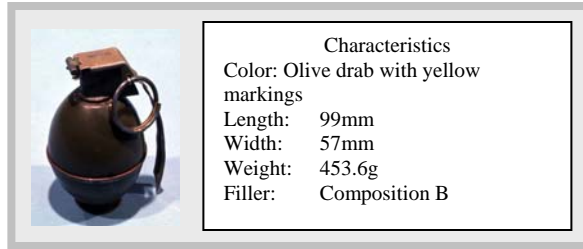

- Figure F-3. French Grenade, Fragmentation, TN 733

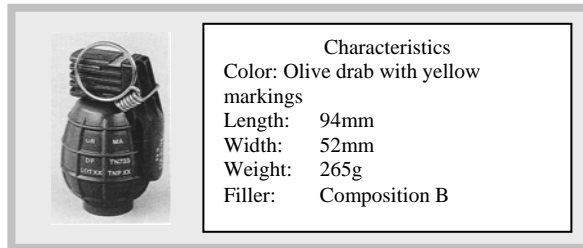

- Figure F-4. U.K. Grenade, Fragmentation, No. 36M MK1

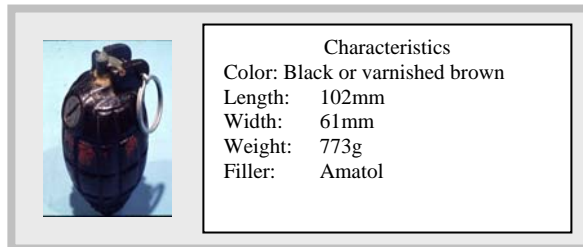

- Figure F-5. Spanish Grenade, Fragmentation, POM 1

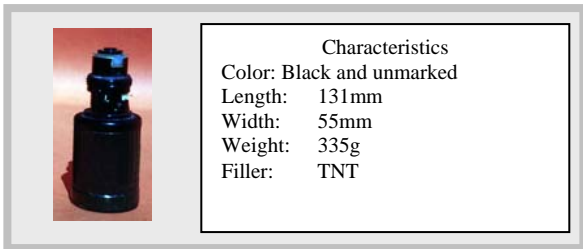

- Figure F-6. U.S.S.R. Grenade, Hand, Defensive, RGD-5

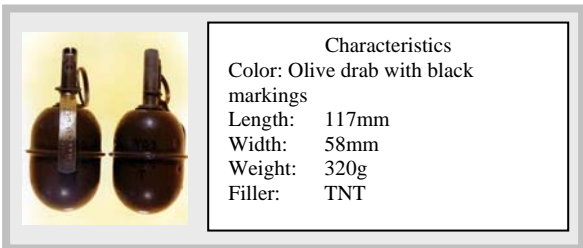

- Figure F-7. U.S.S.R. Grenade, Hand, Defensive, F1

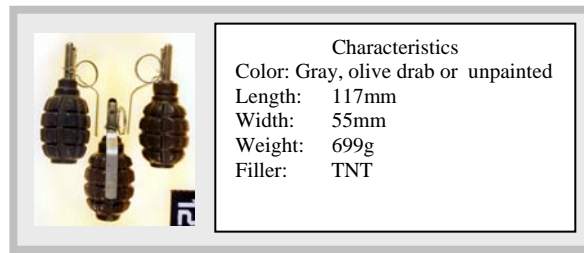

- Figure F-8. North Korean Grenade, Fragmentation, Model Unknown

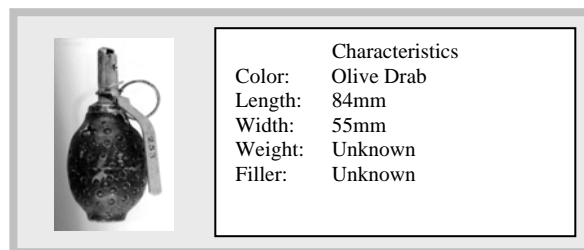

- Figure F-9. Chinese (P.R.) Grenade, Fragmentation, Type 86P

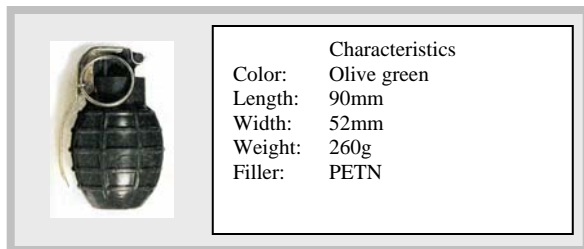

Rocket Propelled Grenade

This weapon fires a motorized grenade from a tube-like launcher. Although it is an unguided weapon, a trained operator can negotiate targets at a long distance. Even though it was originally developed for an anti-tank weapon system, many terrorists use them as anti-aircraft weapons. RPGs were used to bring down two MH-47 Chinook helicopters in the Shah-e-Kot area of Afghanistan in 2002 and the same system was used in 1993 in Mogadishu, Somalia, when Somalis firing RPGs brought down a pair of UH-60 Black Hawk helicopters. Many armies use these systems and they are widely available on the weapons black market.

- Russian 40mm Anti-tank Grenade Launcher RPG-7V. The RPG-7V is abundant throughout the terrorist world and is being used extensively by terrorist organizations in the Middle East and Latin America and is thought to be in the inventory of many insurgent groups. The RPG-7V is a relatively simple and functional weapon, with an effective range of approximately 500 meters when used against a fixed target, and about

300 meters when fired at a moving target.³³⁴ It can penetrate 330mm of armor. Photo is from the TRADOC *Worldwide Equipment Guide* (WEG).

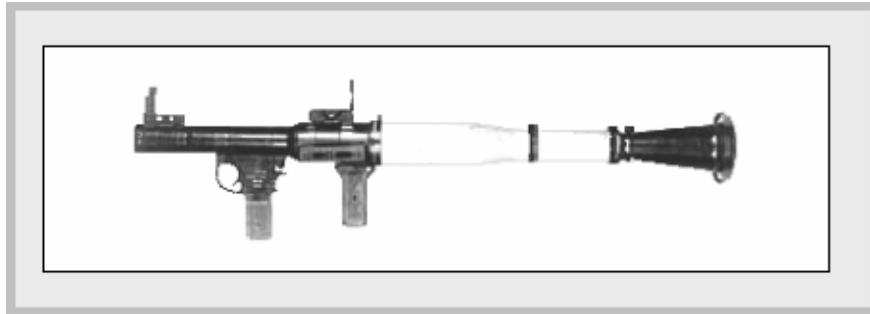

Figure F-10. RPG-7V Antitank Grenade Launcher (Source: WEG)

- U.S. 66mm Light Anti-tank Weapon M72 LAW. Although the M72-series LAW was mainly used as an anti-armor weapon, it may be used with limited success against other targets such as buildings and light vehicles. It's effective range is not as good as the RPG-7V, since it's only effective to 200 meters for stationary targets, and 165 meters for moving targets. It can penetrate 350mm of armor.

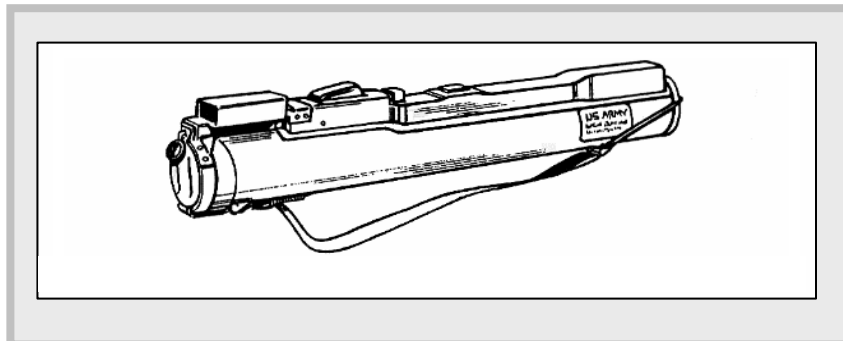

Figure F-11. M72 Series Light Antitank Weapon (Source: FM 23-25)

Air Defense Weapons

Although there are a myriad of air defense weapon systems, the man portable systems are the ones that will be covered in this section. As the name indicates, these systems are portable and can be employed by terrorists very quickly. Due to excellent performance and the large number of these air defense systems throughout the world, the two systems discussed below represent some of the most formidable threats to aircraft of all types. The fact that terrorists

³³⁴ *Conventional Terrorist Weapons* (New York: United Nations Office for Drug Control and Crime Prevention, 2002), 3; available from http://www.undcp.org/odccp/terrorism_weapons_conventional.html; Internet; accessed 12 November 2002.

will use these weapons was demonstrated in November 2002 when two surface-to-air missiles were fired at a Tel Aviv bound Arkia airlines Boeing 757 as it departed Mombasa, Kenya. Fortunately the missiles missed their target, but it is an indication of possible employment of the systems in the future.

- U.S. FIM92A Stinger. The US-made Stinger is a man-portable infrared-guided shoulder-launched Surface-To-Air Missile (SAM). It proved to be highly effective in the hands of Afghan Mujahedeen guerrillas during their insurgency against the Soviets. Its maximum effective range is approximately 4,000+ meters. Its maximum effective altitude is approximately 3,500 meters. It has been used to target high-speed jets, helicopters, and commercial airliners.

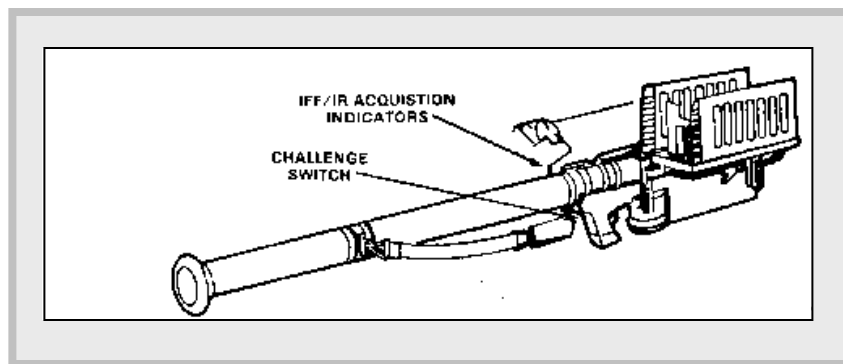

Figure F-12. U.S. FIM92A Stinger (Source: FM 44-18-1)

- Russian SA 7b/Grail. Sold by the thousands after the demise of the former Soviet Union, the SA-7 "Grail" uses an optical sight and tracking device with an infrared seeking mechanism to strike flying targets. Its maximum effective range is approximately 5,500 meters and maximum effective altitude is approximately 4,500 meters. It is known to be in the stockpiles of several terrorist and guerrilla groups.

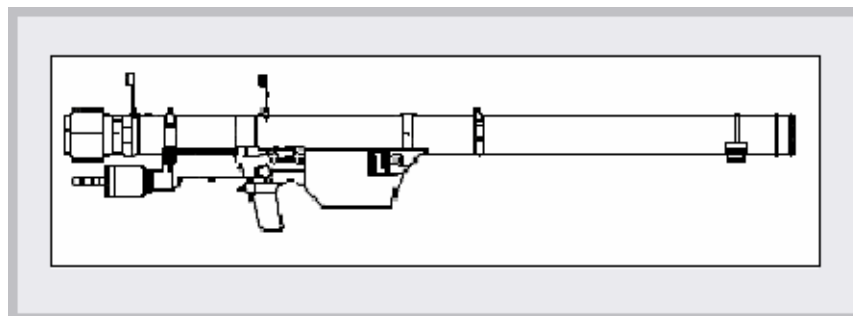
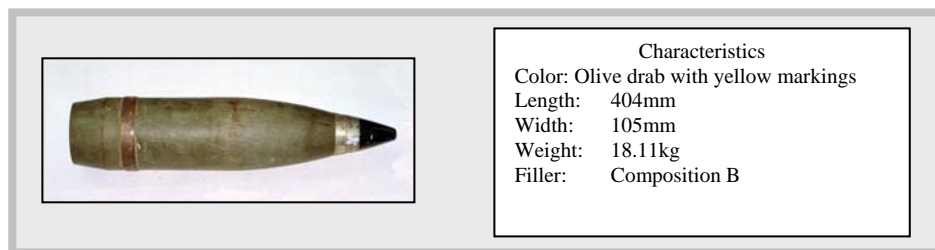

Figure F-13. Russian SA 7b/Grail (Source: WEG)

Bombs and Artillery

Although most bombs used by terrorists are fabricated devices, they do use some conventional munitions, especially as booby traps. They often use unexploded ordnance and modify it for their purposes. A 2001 report from the United Nations Mine Action Coordination Center on the former Yugoslav Republic of Macedonia indicates a plethora of unexploded munitions, to include 122 mm artillery rounds, 100 mm tank rounds, 82 mm and 120 mm mortar rounds, 20 mm and 30 mm cannon rounds, and 50 mm rocket rounds.³³⁵ The following reflects some common munitions used by terrorist organizations. These figures are courtesy of the Naval Explosive Ordnance Disposal Technology Division.³³⁶

- Figure F-14. U.S. Artillery Projectile, 105mm, HE, M1



- Figure F-15. U.S. Artillery Projectile, 155mm, HE, M107



³³⁵C.J. Clark, *Mine/UXO Assessment: Former Yugoslav Republic of Macedonia* (New York: United Nations Mine Action Coordination Center, 8 October 2001), 2; available from http://www.mineaction.org/sp/mine_awareness/_refdocs.cfm?doc_ID=707; Internet; accessed 13 December 2002.

³³⁶Department of Defense, Naval Explosive Ordnance Disposal Technology Division, *ORDATA II - Enhanced Deminers' Guide to UXO Identification, Recovery, and Disposal*, Version 1.0, [CD-ROM], (Indian Head, MD: Naval Explosive Ordnance Disposal Technology Division, 1999).

- Figure F-16. U.S.S.R. Artillery Projectile, 122mm, HE, FRAG, Model OF-472



- Figure F-17. U.S.S.R. Projectile, 100 mm, HEAT-FS, Model ZBK-5M

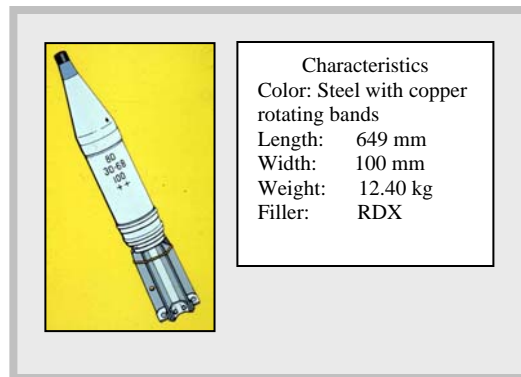

- Figure F-18. U.S.S.R. Projectile, 120 mm, Mortar, HE-FRAG, Model OF-843A

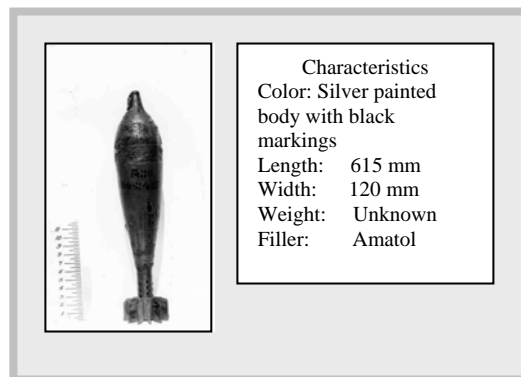

- Figure F-19. U.S. Bomb, 220 lb, Fragmentary, AN-M88

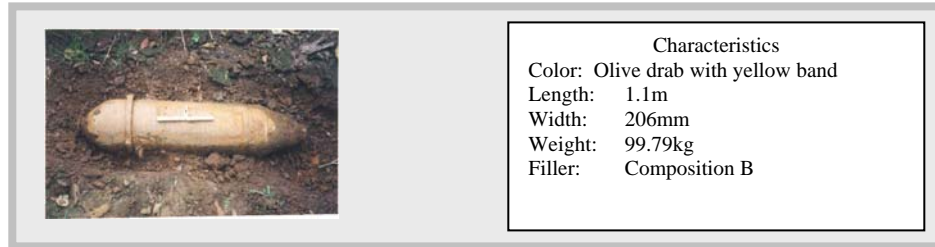

- Figure F-20. U.S. Bomb, 250 lb, GP, AN-M57 & AN-M57A1



- Figure F-21. U.S. Bomb, 500 lb, GP, MK3, MOD 1

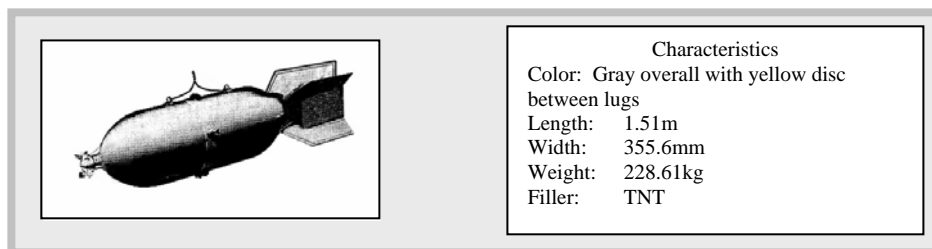

Mines

Similar to the homemade bombs used by terrorists, mines are another means used to inflict damage by terrorist organizations. They use both anti-personnel and anti-tank mines. Unlike conventional military forces that use mines against an opposing military force, terrorists use mines to disrupt social, economic, and political operations. Consequently, mines are often placed around schools, on walking paths, around wells, etc., in order to gain the full terror

effects.³³⁷ When examining the proliferation of these type weapons throughout the world, it becomes readily apparent that it will be a true threat to U.S. forces. The information in Table F-1 is from the 2001 Landmine Monitor Report and shows the various countries of the world that are affected by landmines and unexploded ordnance. Many of these mines have been emplaced by terrorist organizations.

<i>Africa</i>	<i>Americas</i>	<i>Asia-Pacific</i>	<i>Europe/ Central Asia</i>	<i>Middle East/ North Africa</i>
Angola	Chile	Afghanistan	Albania	Algeria
Burundi	Colombia	Bangladesh	Armenia	Egypt
Chad	Costa Rica	Burma	Azerbaijan	Iran
Congo-Brazz.	Cuba	Cambodia	Belarus	Iraq
DR Congo	Ecuador	China	Bosnia & Herzegovina	Israel
Djibouti	El Salvador	India	Croatia	Jordan
Eritrea	Guatemala	North Korea	Cyprus	Kuwait
Ethiopia	Honduras	South Korea	Czech Republic	Lebanon
Guinea-Bissau	Nicaragua	Laos	Denmark	Libya
Kenya	Peru	Mongolia	Estonia	Morocco
Liberia	Falkland-Malvinas	Nepal	Georgia	Oman
Malawi		Pakistan	Greece	Syria
Mauritania		Philippines	Kyrgyzstan	Tunisia
Mozambique		Sri Lanka	Latvia	Yemen
Namibia		Thailand	Lithuania	Golan Heights
Niger		Vietnam	FYR Macedonia	Northern Iraq
Rwanda		Taiwan	Moldova	Palestine
Senegal			Poland	Western Sahara
Sierra Leone			Russia	

³³⁷ Margaret Buse, "Non-State Actors and Their Significance," *Journal of Mine Action* (December 2002): 2; available from http://maic.jmu.edu/journal/5.3/features/maggie_buse_nsa/maggie_buse.htm; Internet; accessed 13 December 2002.

Somalia			Tajikistan	
Sudan			Turkey	
Swaziland			Ukraine	
Tanzania			Uzbekistan	
Uganda			Yugoslavia	
Zambia			Abkhazia	
Zimbabwe			Chechnya	
Somaliland			Kosovo	
			Nagomo-Karabakh	
<p>Source: "Humanitarian Mine Action", <i>Landmine Monitor Report – 2001</i>; available from http://www.icbl.org/lm/2001/exec/hma.html#Heading514; Internet; accessed 13 December 2002.</p>				

Table F-1. Landmine/UXO Problem in the World Today

There are hundreds of different types of mines that can be employed against our troops. As Robert Williscroft stated in *Defense Watch*, "At least 800 different mine types populate the world's minefields. These range from homemade coffee can bombs to sophisticated 'smart' non-metallic devices that can distinguish between potential targets."³³⁸ Homemade bombs were discussed in Appendix E on IEDs, so they will not be addressed again. Manufactured mines used by terrorists originate from many of the former Warsaw Pact countries, the United States, China, Britain, and Iran, to name just a few sources.³³⁹ Some common mines are shown below. These can be detonated through the use of trip wires, pressure, or command detonation. These figures are courtesy of the Naval Explosive Ordnance Disposal Technology Division.³⁴⁰

- Figure F-22: Chinese (P.R.) Landmine, APERS, Type 59

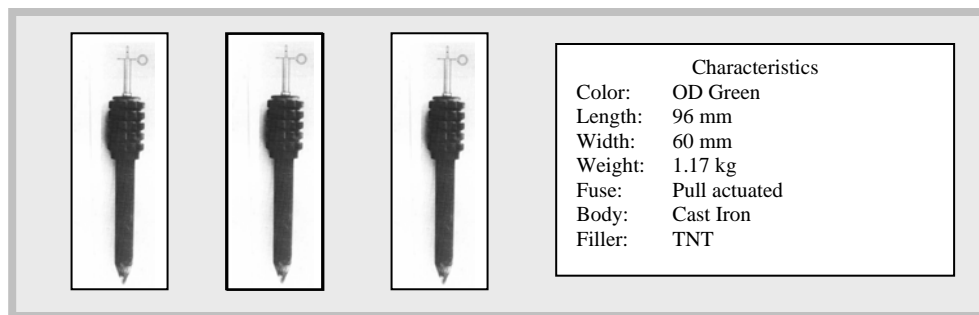

³³⁸Robert G. Williscroft, "The Economics of Demining Defines Success and Failure," *Defense Watch* (13 February 2002): 4; available from <http://www.sftt.org/dw02132002.html>; Internet; accessed 13 December 2002.

³³⁹C.J. Clark, *Mine/UXO Assessment: Former Yugoslav Republic of Macedonia* (New York: United Nations Mine Action Coordination Center, 8 October 2001), 2; available from http://www.mineaction.org/sp/mine_awareness_refdocs.cfm?doc_ID=707; Internet; accessed 13 December 2002; and Jerry White, "Ridding the World of Land Mines," *Union-Tribune* (24 January 2002): 4; available from <http://www.wand.org/9-11/discuss6.html>; Internet; accessed 13 December 2002.

³⁴⁰Department of Defense, Naval Explosive Ordnance Disposal Technology Division, *ORDATA II - Enhanced Deminers' Guide to UXO Identification, Recovery, and Disposal*, Version 1.0, [CD-ROM], (Indian Head, MD: Naval Explosive Ordnance Disposal Technology Division, 1999).

- Figure F-23. Chinese (P.R.) Landmine, APERS, Type 66

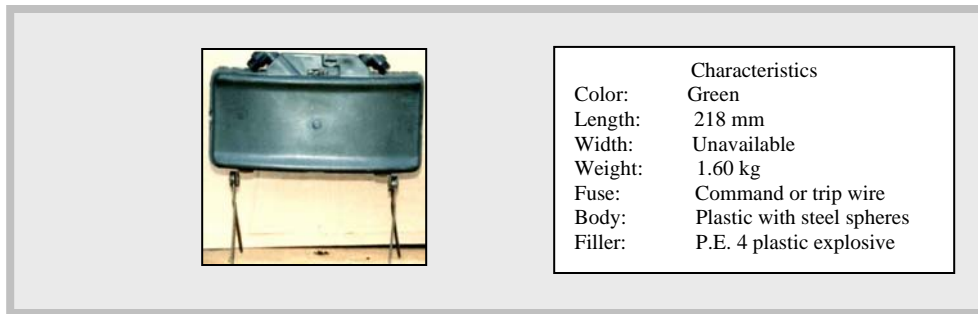

- Figure F-24. Chinese (P.R.) Landmine, AT, Type 72

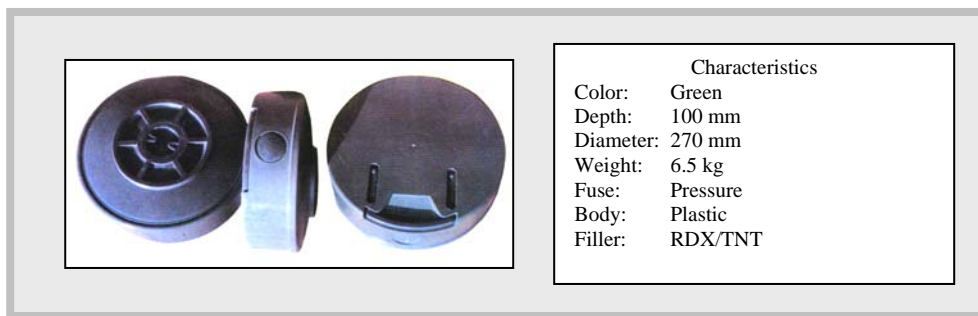

- Figure F-25. U.S. Landmine, APERS, HE, M14

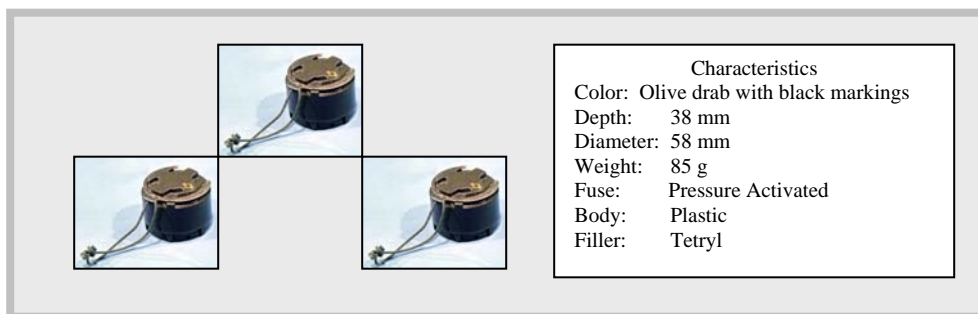

- Figure F-26. U.S. Landmine, APERS, HE, M18A1



- Figure F-27. U.S. Landmine, AT, HE, M21



- Figure F-28. U.S.S.R. Landmine, APERS, Directional, MON-50

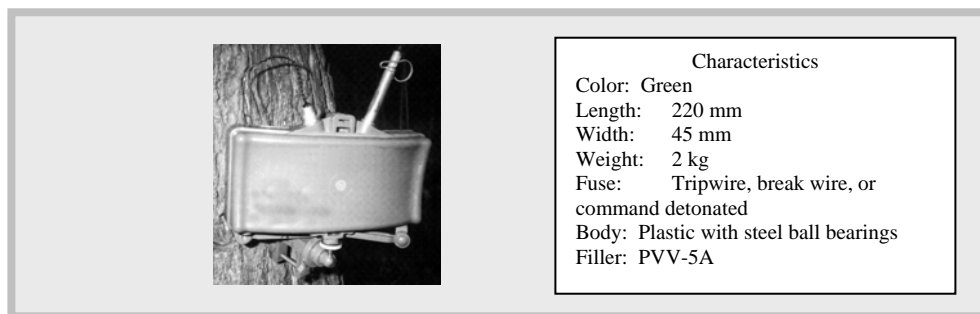

- Figure F-29. U.S.S.R. Landmine, APERS, PMN-2



- Figure F-30. U.S.S.R. Landmine, AT, TM-62M



- Figure F-31. Yugoslav Landmine, APERS, PMA-2

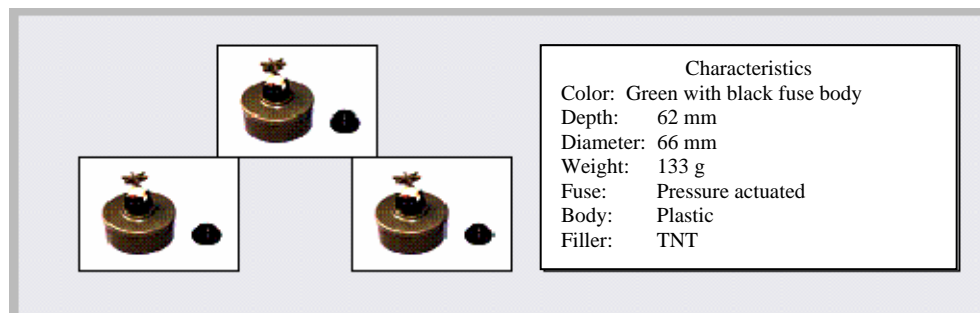

- Figure F-32. Yugoslav Landmine, APERS, PMR-2A

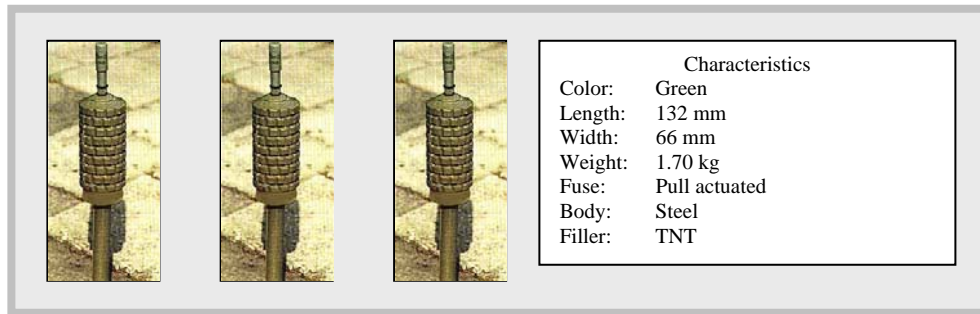

- Figure F-33. Yugoslav Landmine, AT, TMA-4

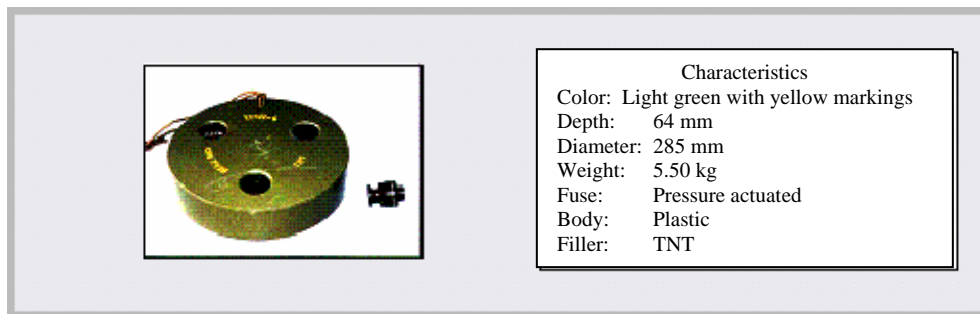

Appendix G

Weapons of Mass Destruction/Effect

The future may see a time when such a [nuclear] weapon may be constructed in secret and used suddenly and effectively with devastating power by a willful nation or group against an unsuspecting nation or group of much greater size and material power.

U.S. Secretary of War Henry Stimson to Harry Truman
25 April 1945

General

The specter of weapons of mass destruction (WMD) has existed ever since the term arose in the mid-twentieth century. Actions in World War II witnessed the entry of atomic weapons and their destructive effects, and started a subsequent arms race among nations to obtain and wield such an instrument of power. On closer reflection, other weapons of mass destruction have existed for centuries. Examples include biological vectors used to spread disease among adversaries in ancient and modern periods, or the more recent use of massive chemical weapon attacks in World War I. The acronym “NBC” emerged in the post-World War II era to catalog the main types of mass destruction as nuclear, biological, and chemical weapons.

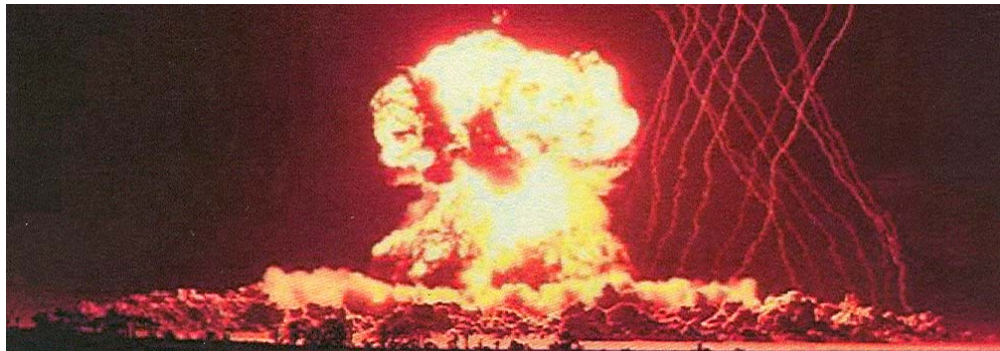

Fig. G-1. U.S. Nuclear Bomb Detonation
(Source: U.S. Government)

More recently, other means of mass destruction or mass disruption effects entered the lexicon. Radiological weapons, often called radiological dispersal devices (RDD), add to a grouping of weapon capabilities as chemical, biological, radiological, and nuclear (CBRN). High yield explosives can also be considered a weapon of mass destruction. The recognition of explosives with high yield effects now adds a category to weapons of mass destruction and a contemporary acronym of CBRNE.

CBRNE Background

The threat of terrorists using weapons of mass destruction appears to be rising. Incidents since the 1980s spotlight the attention that mass casualties or mass destruction cause in a contemporary setting of near instantaneous global information access. Terrorists quickly realized the value of sensational events that might prompt a change in national policies, alter regional security arrangements, or thrust obscure issues into an international spotlight. The vehicular bombing of the U.S. Embassy in Lebanon in 1983, the World Trade Center in 1993, the U.S. military housing area at Khobar Towers in 1996, the U.S. Embassies in Kenya and Tanzania in 1998, and the aerial attack on the World Trade Center on September 11, 2001 are examples of an escalating notoriety in terrorist assaults. These acts demonstrate the capability and conduct of terrorists to plan, organize, and execute attacks to produce mass casualties.³⁴¹ In an unclassified report to the U.S. Congress, the Central Intelligence Agency stated that many of the over 30 designated foreign terrorist organizations have expressed interest in acquiring WMD.³⁴² Additionally, terrorists state interest in conducting unconventional attacks and make public statements about unconventional weapons.³⁴³ Some terrorists profess that the acquisition of WMD to be a [extremist] religious duty and threaten to use them.³⁴⁴

“The United States of America is fighting a war against terrorists of global reach. The enemy is not a single political regime or person or religion or ideology. The enemy is terrorism – premeditated, politically motivated violence perpetrated against innocents.”

National Security Strategy of the United States of America

Terrorist groups that acquire CBRNE weapons pose a critical danger. Terrorists armed with these weapons can gain leverage for their demands by threatening use of these weapons to influence political or military actions or to achieve a specific economic or financial objective. Likewise, some groups simply want to employ WMD to create large numbers of casualties, both military and civilian, and capitalize on the effects of these events.³⁴⁵

In a May 1998 interview, Usama bin Laden stated, “We do not have to differentiate between military or civilian. As far as we are concerned, they are all targets, and this is what the fatwa

³⁴¹ Department of State, *Patterns of Global Terrorism 2001* (Washington, D.C., May 2002), 66.

³⁴² Director of Central Intelligence, DCI Weapons Intelligence, Nonproliferation, and Arms Control Center, *Unclassified Report to Congress on the Acquisition of Technology Relating to Weapons of Mass Destruction and Advanced Conventional Munitions, 1 January Through 30 June 2003* (Washington, D.C., January 2002), 7; available from http://www.cia.gov/cia/reports/721_reports/pdfs/jan_jun2003.pdf; Internet; accessed 19 May 2004.

³⁴³ *Ibid.*, 8-9.

³⁴⁴ Department of State, *Patterns of Global Terrorism 2001* (Washington, D.C., May 2002), 66.

³⁴⁵ The White House, National Security Presidential Directive 17 (NSPD-17), *National Strategy to Combat Weapons of Mass Destruction*, (Washington, D.C., December 2002), 4 and 10; available from <http://www.fas.org/irp/offdocs/nspd/nspd-17.html>; Internet; accessed 8 December 2003.

says.”³⁴⁶ Additionally, al Qaeda spokesman Suleiman abu Ghaith has stated: “We have the right to kill four million Americans – two million of them children – and to exile twice as many and injure and cripple hundreds of thousands. We have the right to fight them by chemical and biological weapons, so they catch the fatal and unusual diseases that Muslims have caught due to their [U.S.] chemical and biological weapons.”³⁴⁷ These statements by al Qaeda leave no doubt that some terrorists are committed to using weapons of mass destruction if they can acquire them. In the Cold War era of earlier decades in the twentieth century, weapons of mass destruction were considered weapons of last resort and threatened mutual devastation among super-powers. Today, some terrorists see weapons of mass destruction as weapons of choice.³⁴⁸

“Acquiring weapons for the defense of Muslims is a religious duty. If I have indeed acquired these weapons (WMD), then I thank God for enabling me to do so. And if I seek to acquire these weapons, I am carrying out a duty. It would be a sin for Muslims not to try to possess the weapons that would prevent the infidels from inflicting harm on Muslims.”

Usama Bin Laden interview with *Time Magazine*, December 23, 1998

Weapons of Mass Destruction Categories

Weapons of mass destruction are normally classified into five categories: chemical, biological, radiological, nuclear, and high yield explosives.

“Rogue states and terrorists do not seek to attack us using conventional means. They know such attacks would fail. Instead, they rely on acts of terror and, potentially, the use of weapons of mass destruction – weapons that can be easily concealed, delivered covertly, and used without warning.”

National Security Strategy of the United States of America

³⁴⁶ Ben N. Venzke and Aimee Ibrahim, *al Qaeda Tactic/Target Brief*, Version 1.5 (Alexandria, VA: IntelCenter, 2002), 8.

³⁴⁷ *Ibid.*, 10.

³⁴⁸ National Security Strategy of the United States of America, 8.

Chemical Weapons

The range of chemical weapons contains substances intended to kill or incapacitate personnel and to deny use of areas, materiel, or facilities. Agents can be both lethal and non-lethal, and can be either persistent or nonpersistent. As with biological weapons, terrorists have already exhibited the capability to use chemical weapons. One example was demonstrated in 1978 when a group of Palestinians injected oranges with cyanide to damage Israel's citrus exports.³⁴⁹ Additionally, in 1995 the Japanese cult Aum Shinrikyo released sarin nerve agent in the Tokyo subway network killing 12 people and injuring 5,500.³⁵⁰ The Aum Shinrikyo attack shows the unpredictable nature of chemical weapons and problematic issues of dissemination. This Japanese cult was able to produce and release sarin in a closed environment, but fortunately, the effects were much less deadly than planned by the terrorists.

The aerial attacks on September 11, 2001 by suicidal aircraft raised the chemical industry's awareness of possible terrorist sabotage of facilities that store toxic industrial chemicals. These type attacks could provide the mass casualty effects of a chemical weapons attack, yet would not present the terrorist group with the problem of developing or acquiring chemical agents. A tragic scenario occurred in Bhopal, India in 1984 when a disgruntled pesticide plant employee is believed to have released 40 metric tons of methyl isocyanate into the atmosphere. The resulting casualties were 2,000 local residents killed and 100,000 injured people.³⁵¹

Chemical agents are categorized by the effects they have on the target population. Lethal agents include nerve, blood, blister, and choking agents. Nonlethal agents include incapacitants and irritants.

Table G-1 lists characteristic effects of various chemical agents.

<i>Agent</i>	<i>Lethal</i>	<i>Symbol Name</i>	<i>Symptoms in Man</i>	<i>Effects on Man</i>	<i>Rate of Action</i>
<i>Nerve</i>	Yes	G Series GB/Sarin GD/Soman (VR 55)	Difficult breathing, sweating, drooling, nausea, vomiting convulsions, and dim or blurred vision.	At low concentrations, incapacitates; Kills if inhaled or absorbed through The skin.	Very rapid by inhalation ; slower through skin (5-10 minutes).

³⁴⁹ *Encyclopedia of World Terrorism*, 1997 ed., s.v. "Chemical."

³⁵⁰ Walter Laqueur, *The New Terrorism: Fanaticism and the Arms of Mass Destruction* (Oxford: Oxford University Press, 1999), 54.

³⁵¹ Steve Bowman, *Weapons of Mass Destruction: The Terrorist Threat* (Washington, D.C.: Congressional Research Service Report for Congress, 7 March 2002), 7; available from <http://www.fas.org/irp/crs/RL31332.pdf>; Internet; accessed 23 December 2002.

	Yes	V Agent	Same as above.	Incapacitates; kills if skin is not rapidly decontaminated.	Delayed through skin; more rapid through eyes.
Blood	Yes	AC/Hydrogen cyanide	Rapid breathing, convulsions, coma, and death.	Incapacitates; kills if high concentration is inhaled.	Rapid
Blister	Yes	HD/Mustard HN/Nitrogen Mustard L/Lewisite HL/Mustard and Lewisite CX/Phosgene Oxime	Mustard, nitrogen mustard: no early symptoms. Lewisite and mustard: searing eyes and stinging skin. Phosgene oxime: powerful irritation of eyes, nose, and skin.	Blisters skin and respiratory tract; can cause temporary blindness. Some agents sting and form wheals on skin.	Blister delayed hours to days; eye effects more rapid.
Choking	Yes	CG/Phosgene DP/Diphosgene	Eye-throat irritation, fatigue, tears, cough, chest tightness, nausea, vomiting.	Damages the lungs.	Delayed, variable.
Incapacitant	No	BZ	Slowing of mental and physical activity, disorientation/sleep.	Temporarily incapacitates.	30-60 minutes.
Irritant	No	DA/Diphenyl chloroarsine DM/Adamsite CN/Chloroacetophenone CS/O-Chlorobenzylidene-malonitrile PS/Chloropicrin	Causes tears, irritates skin and respiratory tract.	Incapacitates, non-lethal.	Very rapid.

Table G-1. Effects of Example Chemical Agents.

Nerve agents are fast-acting chemical agents. Practically odorless and colorless, they attack the body's nervous system causing convulsions and eventually death. Nerve agents are further classified as either G or V agents.

At low concentrations, the GB series incapacitates; it kills if inhaled or absorbed through the skin. The rate of action is very rapid if inhaled, but slower if absorbed through the skin. The V-agents are quicker acting and more persistent than the G-agents.

Blood agents are absorbed by breathing and block the oxygen transferal mechanisms in the body, leading to death by suffocation. A common blood agent is hydrogen cyanide. It kills quickly and dissipates rapidly.

Blister agents, such as mustard (H) or lewisite (L), and combinations of the two compounds, can disable or kill. These type agents burn the skin and produce large blisters. They also cause damage to the eyes, blood cells, and lungs. These agents are especially harmful when inhaled.

Choking agents, such as phosgene and diphosgene, attack the respiratory system and make the membranes swell so the lungs fill with fluid, which can be fatal. As with blood agents, poisoning from choking agents comes through inhalation, since both types of agents are nonpersistent. Signs and symptoms of toxicity may be delayed up to 24 hours.

Incapacitants include psychochemical agents and paralyzants. These agents can disrupt a victim's mental and physical capabilities. The victim may not lose consciousness, and the effects usually wear off without leaving permanent physical injuries.

Irritants, also known as riot-control agents, cause a strong burning sensation in the eyes, mouth, skin, and respiratory tract. The effects of these agents, the most commonly known being "tear gas" (CS), are also temporary. Victims recover without having any serious aftereffects.

Chemical agents are also classified according to their persistency. Persistency is the length of time an agent remains effective on the battlefield or other target area after dissemination. The two basic classifications are persistent or nonpersistent.

Persistent nerve agents, such as V-agents, thickened G-agents, and the blister agent mustard, can retain their disabling or lethal characteristics for days to weeks (depending on environmental conditions). Persistent agents produce either immediate or delayed casualties. Immediate casualties occur when an individual inhales a chemical vapor. Delayed casualties occur when the chemical agent is absorbed through the skin, thus demonstrating the need for protective equipment.



Fig. G-2. Chemical Protection
(Source: U.S. Army Photo)

Nonpersistent agents generally last a shorter period of time, depending on the weather conditions. For example, the nerve agent sarin (GB) forms clouds that dissipate within minutes after dissemination. However, some liquid GB could remain for periods of time varying from hours to days, depending on the weather conditions and method of delivery.

Dissemination is a significant difficulty in using chemical weapons and achieving the desired weapon effects. Vapors are affected by the direction of the wind as well as temperature. Additionally, there are biological activities that diminish the toxicity of the agent, therefore, the amount of chemical needed in the open air or in water to have its intended effect is much larger than what is successful in the laboratory.³⁵²

Numerous means to include mortars and bombs can be used to deliver chemical warfare agents. Chemical munitions are fitted with different burst capabilities, according to the agent properties and the intended effect. For example, a chemical munitions fitted with a long burst fuse releases the agent as a vapor or fine aerosol. This creates an immediate inhalation hazard with some of the fragmentation effect of conventional munitions. Theoretically, terrorists could obtain these munitions, modify them and emplace them by hand. Delivery means could be by vehicle, backpack, canisters or sprayers, similar to those used for biological agents. Another means could be the misuse of toxic industrial chemicals in massive quantities.

Toxic Industrial Chemicals

There is a near-universal availability of large quantities of highly toxic stored materials. Exposure to some industrial chemicals can have a lethal or debilitating effect on humans, which, in combination with their ready availability, their proximity to urban areas, their low cost, and the low security associated with storage facilities, makes them an attractive option for terrorist use as weapons of opportunity or of mass destruction.

The most important factors to consider when assessing the potential for adverse human health impacts from a chemical release are acute toxicity, physical properties (volatility, reactivity, flammability), and likelihood that large quantities will be available for exploitation. Foremost among these factors is acute toxicity; thus, the highest concern for human health is associated with a subgroup of industrial chemicals known as toxic industrial chemicals (TICs). TICs are commercial chemical substances with acute toxicity that are produced in large quantities for industrial purposes. Knowledge of where these type chemicals are stored and how they are transported are only two of many factors in assessing possible terrorist use.

Table G-2 lists high- and moderate-risk TICs based on acute toxicity by inhalation, worldwide availability (number of producers and number of continents on which the substance is available), and physical state (gas, liquid, or solid) at standard temperature and pressure.

<i>High Risk</i>	<i>Moderate Risk</i>	
Ammonia	Acetone cyanohydrin	Methyl chloroformate
Arsine	Acrolein	Methyl chlorosilane

³⁵²Walter Laqueur, *The New Terrorism: Fanaticism and the Arms of Mass Destruction* (Oxford: Oxford University Press, 1999), 60.

Boron trichloride	Acrylonitrile	Methyl hydrazine
Boron trifluoride	Allyl alcohol	Methyl isocyanate
Carbon disulfide	Allyl amine	Methyl mercaptan
Chlorine	Allyl chlorocarbonate	n-Butyl isocyanate
Diborane	Boron tribromide	Nitrogen dioxide
Ethylene oxide	Carbon monoxide	Phosphine
Fluorine	Carbonyl sulfide	Phosphorus oxychloride
Formaldehyde	Chloroacetone	Phosphorus pentafluoride
Hydrogen bromide	Chloroacetonitrile	Selenium hexafluoride
Hydrogen chloride	Chlorosulfonic acid	Silicon tetrafluoride
Hydrogen cyanide	Crotonaldehyde	Stibine
Hydrogen fluoride	Diketene	Sulfur trioxide
Hydrogen sulfide	1,2-Dimethyl hydrazine	Sulfuryl chloride
Nitric acid, fuming	Dimethyl sulfate	Tellurium hexafluoride
Phosgene	Ethylene dibromide	Tert-Octyl mercaptan
Phosphorus trichloride	Hydrogen selenide	Titanium tetrachloride
Sulfur dioxide	Iron pentacarbonyl	Trichloroacetyl chloride
Sulfuric acid	Methanesulfonyl chloride	Trifluoroacetyl chloride
Tungsten hexafluoride	Methyl bromide	

Table G-2. High- and Moderate-Risk Toxic Industrial Chemicals

Some chemicals in solid form need only to be exposed to air or water in order to turn into a toxic gas. In addition, the current definition of TICs does not include all chemicals with high toxicity and availability. Specifically, chemicals with low volatility are not included. These low-vapor-pressure chemicals include some of the most highly toxic chemicals widely available, including most pesticides.

Biological Weapons

Biological weapons consist of pathogenic microbes, toxins, and bioregulator compounds. Depending on the specific type, these weapons can incapacitate or kill people and animals; and destroy plants, food supplies, or materiel. The type of targets being attacked determines the choice of agents and dissemination systems.

Biological warfare agents are virtually undetectable while they are in transit and evidence of a biological attack may not show up for days after the actual release has occurred. These agents are easier and cheaper to produce than either chemical or nuclear weapons, and the technology is readily available on the Internet. In fact, any nation with a modestly sophisticated pharmaceutical industry is capable of producing these type agents.³⁵³ Biological

³⁵³ Canadian Security Intelligence Service, "Report 2000/05 Biological Weapons Proliferation," *Perspectives* (9 June 2000): 2; available from http://www.csis-scrs.gc.ca/eng/miscdocs/200005_e.html; Internet; accessed 6 February 2003.

agents are also very lethal. Whereas about 1800 pounds of sarin is required to inflict a large number of casualties over a square mile area, under ideal conditions, only a quarter ounce of anthrax spores is required to achieve the same effect.³⁵⁴

The Fall 2001 anthrax attacks in the United States following the World Trade Center and Pentagon bombings show that terrorists will use biological weapons. Although the anthrax attacks were originally suspected as linked to al Qaeda or Iraq, there is no evidence that a known terrorist organization was involved. Current views indicate that the attacks were probably domestically initiated or that a lone terrorist with previous access to weapon quality anthrax conducted them.³⁵⁵ Although the outcome of these attacks resulted in few casualties, the attacks did show the psychological and economic disruption such attacks could cause. Washington, D.C. and other East Coast cities were in a panic dealing with these attacks. Additionally, the numerous hoaxes using talcum powder showed the psychological and economic impact of the potential use of these type weapons.

Although the anthrax attacks from 2001 achieved recognizable publicity, biological attacks in the United States are not new. Biological terrorism occurred in Oregon in 1984 with food tampering. Followers of the Bagwan Shree Rajneesh cult placed salmonella on salad bar food in several restaurants, causing over 700 people to become ill.³⁵⁶

Biological warfare agents include three basic categories: pathogens, toxins, and bioregulators. Table G-3 lists some examples of each.

<i>Pathogens</i>	<i>Toxins</i>	<i>Bioregulators</i>
Anthrax	Mycotoxins	Neurotransmitters
Cholera	Venoms	Hormones
Plague	Shell fish	Enzymes
Smallpox	Botulinum	
Tularemia	Ricin	
Influenza		
Fevers		

Table G-3. Examples of Biological Warfare Agents

Some of the characteristics of biological weapons are shown in the following table³⁵⁷:

³⁵⁴ *Encyclopedia of World Terrorism*, 1997 ed., s.v. "Biological."

³⁵⁵ Steve Bowman, *Weapons of Mass Destruction: The Terrorist Threat* (Washington, D.C.: Congressional Research Service Report for Congress, 7 March 2002), 3; available from <http://www.fas.org/irp/crs/RL31332.pdf>; Internet; accessed 23 December 2002.

³⁵⁶ Department of Justice, Federal Bureau of Investigation, Counterterrorism Threat Assessment and Warning Unit, Counterterrorism Division, *Terrorism in the United States 1999*, Report 0308, (Washington, D.C., n.d.), 39.

³⁵⁷ Lewis M. Simons, "Weapons of Mass Destruction: An Ominous New Chapter Opens on the Twentieth Century's Ugliest Legacy," *National Geographic* 202, no. 5 (November 2002): 22-23.

<i>Agent</i>	<i>Contagious</i>	<i>Mortality Untreated</i>	<i>if</i>	<i>Incubation Period (Days)</i>	<i>Illness Duration (Days)</i>
<i>Anthrax</i>	No	90-100%		1-7	3-5
<i>Plague</i>	Yes	100%		1-6	Fatal within 6
<i>Tularemia</i>	No	30-40%		1-14	14 or more
<i>Smallpox</i>	Yes	30%		7-17	10-28
<i>Botulinum</i>	No	60-100%		1-5	Days to weeks
<i>Ricin</i>	No	Variable		18-24 hours	Days

Table G-4. Characteristics of Biological Weapons

Pathogens cause diseases such as anthrax, cholera, plague, smallpox, tularemia, or various types of fever. These weapons could be used against targets such as food supplies, port facilities, and population centers. Of particular concern is the threat of contagious diseases, such as smallpox. Since it has an incubation period that can last over 2 weeks without any symptoms, the release of smallpox could easily infect a large number of people in a short period of time.

Living organisms, such as snakes, spiders, sea creatures, and plants, produce toxins. Toxins are faster acting and more stable than live pathogens. Most toxins are easily produced through genetic engineering.



Fig. G-3. **Man with Smallpox**
(Source: CDC/Barbra Rice)

Bioregulators are chemical compounds that are essential for the normal psychological and physiological functions. A wide variety of bioregulators are normally present in the human body in extremely minute concentrations. These compounds can produce a wide range of harmful effects if introduced into the body at higher than normal concentrations or if they have been altered. Psychological effects could include exaggerated fear and pain. In addition, bioregulators can cause severe physiological effects such as rapid unconsciousness, and, depending on such factors as dose and route of administration, they could also be lethal. Unlike pathogens that take hours or days to act, bioregulators could act in only minutes.

Another way to categorize biological warfare agents is by their effects. The four categories and effects of biological agents are shown in Table G-5. There is a threat of agro-terrorism, which affects plants and animals. The outbreaks of foot-and-mouth disease and mad cow disease in Europe and the isolated case of mad cow in the U.S. state of Washington³⁵⁸ are recent examples of the economic impact of such diseases. Additionally, this type terrorism allows a terrorist group to inflict significant economic and social disruption without the

³⁵⁸ "Final BSE Update – Monday, February 9, 2004," USDA United States Department of Agriculture website; available from <http://usda.gov/Newsroom/0074.04.html>; Internet; accessed 12 July 2004.

stigma of inflicting large numbers of human casualties.³⁵⁹ Based on statements from al Qaeda that they intend to target key sectors of the U.S. economy, agro-terrorism is a likely threat.

<i>Agent Type</i>	<i>Agent Effects</i>
<i>Antipersonnel</i>	Disease or death causing microorganisms and toxins
<i>Antiplant</i>	Living micro-organisms that cause disease or death
<i>Antianimal</i>	Agents that can be used to incapacitate or destroy domestic animals through disease. Used to limit wool, hide, or fur production.
<i>Antimaterial</i>	Agents used to deteriorate critical materiel needed for the war effort such as leather, canvas, fuels, or electronics.

Table G-5. Effects of Biological Agents

Biological dissemination through aerosols, either as droplets from liquid or as particles from powders, is the most efficient method. This method does create a challenge since aerosol disseminators need to be properly designed for the agent used, and proper meteorological conditions must exist to conduct an effective attack.³⁶⁰ The objective of biological weapon delivery is to expose humans to an agent in the form of a suspended cloud of very fine agent particles. Airborne particles, once inhaled, tend to lodge deep in the lungs close to vulnerable body tissues and the bloodstream.

Terrorists can deliver biological weapons by unconventional dissemination means. These include commercially available or specially designed sprayers or other forms of aerosol generators mounted in automobiles, trucks, or ships. Smaller, more portable devices could be used to effectively disseminate biological agent aerosols. Such devices could be used to introduce an agent into heating, ventilating, and air conditioning systems. Drinking water can be contaminated by means of high-pressure agent injectors attached to plumbing system components. Insects, rodents, or other arthropod vectors are other feasible vectors of dissemination. Methods of dissemination are varied and limited only by the terrorist imagination.

Radiological Weapons

Radiological terrorism, a relatively new aspect of WMD and terrorism, is usually conceived as the horrific use of a radiological device or an attack on a nuclear facility such as a nuclear power plant.

Radioactivity is the release of energy in the form of radiation, as some naturally occurring elements attempt to change their fundamental atomic structure. Isotopes are forms of these particular elements that have distinct nuclear properties. When an isotope is unstable, it emits

³⁵⁹ Steve Bowman, *Weapons of Mass Destruction: The Terrorist Threat* (Washington, D.C.: Congressional Research Service Report for Congress, 7 March 2002), 6; available from <http://www.fas.org/irp/crs/RL31332.pdf>; Internet; accessed 23 December 2002.

³⁶⁰ Steve Bowman, *Weapons of Mass Destruction: The Terrorist Threat*, 5.

radiation and is called a radioisotope. Radiation from radioisotopes can damage human cells and cause problematic health issues.³⁶¹

Although physical destruction with a radiological device may be much less than a nuclear detonation, radiological contamination, or the fear of radiation on long-term health issues, may be a key psychological impact. Physical and psychological trauma of a radiological threat can have significant negative effects on the economic, financial, and political programs of a region and nation.

Radiological contamination can occur in multiple ways. One of the more well-known dissemination descriptions is a radiological dispersal device (RDD). This capability uses any number of mechanical means to spread radiation throughout a designated area. Another common term, “dirty bomb,” is an example of using conventional explosives to disperse radioactive material. Other forms of RDD could distribute radioactive material in the atmosphere or in confined areas such as an office complex ventilation system. A passive method of radiological attack could be the use of a radiation-emitting device (RED). In this example, a RED could be positioned to expose a population to intense radiation for a short period of time, or expose a selected population to low radiation over an extended period. The knowledge of contamination, and the fear of physical or psychological harm could be significant.³⁶²

“When 100 years ago authorities had to worry about the anarchist placing a bomb in the downtown square...now we must worry about the terrorist who places the bomb in the square, but packed with radiological material.”

Spencer Abraham, U.S. Secretary of Energy 2003

The many industrial, scientific, agricultural, and public arena uses of radiation make access to certain radiological equipment and materiel a distinct probability for a dedicated individual or group. The 1995 demonstration of Chechnyan rebels burying a container of radioactive material in a Moscow public park received international attention. Not as well known is a 1999 incident of thieves in Grozny, Chechnya attempting to steal a container of radioactive material from a chemical factory. One thief died almost immediately after exposure to the container, and an accomplice was hospitalized in serious condition.³⁶³ As an additional example of radioactive material, the former Soviet Union employed highly radioactive thermoelectric generators (RTG) to remotely power naval navigational systems and other

³⁶¹ ““Chemistry 101”: The Make-up and Importance of Radioisotopes,” *Introduction to Radiological Terrorism*, 1; available from http://www.nti.org/h_learnmore/radtutorial/chapter01_03.html; Internet; accessed 19 May 2004.

³⁶² “What is Radiological Terrorism?” *Introduction to Radiological Terrorism*, 1 and 2; available from http://www.nti.org/h_learnmore/radtutorial/chapter01_02.html; Internet; accessed 19 May 2004.

³⁶³ “History of Radiological Terrorism,” *Introduction to Radiological Terrorism*, 1 to 3; available from http://www.nti.org/h_learnmore/radtutorial/chapter03_01.html; Internet; accessed 19 May 2004.

military facilities.³⁶⁴ In one 2001 incident report, two people scavenging for lead in a Russian facility were hospitalized after dangerous exposure to radioactive material. In a 2001 report from the nation of Georgia, individuals received significant radiation contamination after they handled abandoned containers holding a radioactive substance. In 2003, a report notes that police in the nation of Georgia discovered radioactive containers and other materials in a routine vehicle search.

Although radiation type devices may not necessarily cause mass casualties, they could present a significant radiation contamination effect on the target area.³⁶⁵ Radiation casualties could be low initially, but would potentially increase over time. However, just the fact that a “nuclear” type weapon was employed would have a significant psychological impact on the populace where it is detonated or used. The U.S. Environmental Protection Agency (EPA) guidelines recommend that if a cancer risk due to remaining radiation cannot be reduced to less than one person per 10,000 people, the area should be abandoned. Disaster response and recovery issues of decontamination would include medical treatment of people in the affected area, possible evacuation or relocation of populations, and multiple actions to make physical property and materiel useable with no fear of radiation.³⁶⁶

Instances of acquiring materiel to build radiological devices can be very easy with basic knowledge of processes and a dedicated action plan. One example in 1994 is the attempt by a U.S. citizen to build a breeder reactor in his mother’s garden shed. This incident had nothing to do with terrorism but does highlight risk, and at the time, the relative ease of obtaining radioactive material. As a teenager, David Hahn used his knowledge of chemistry, inquisitive mind, false documents and statements, and false cover stories to acquire radiological material. He constructed a crude radiological device that could have endangered 40,000 local residents. Questioned by local police for an unrelated citizen complaint, the unexpected discovery of radioactive material triggered the Federal Radiological Emergency Response Plan.³⁶⁷

To date, the U.S. has not been attacked with a radiological weapon by terrorists. Nonetheless, theoretical case study examples illustrate the potential impacts of a radiological “dirty bomb.” In testimony before the U.S. Senate Foreign Relations Committee, illustrations and degrees of contamination were estimated on several factors.³⁶⁸ These model assumptions included amount of material released, the specific radiological material, dispersal technique, wind speed and direction and other weather conditions, size of particles released into the wind, and types of urban building construction and urban pattern of populations. Complex models have inherent uncertainties in predictive results, however, one example assumed a conventional

³⁶⁴ “Medical Uses,” *Introduction to Radiological Terrorism*, 3; available from

http://www.nti.org/h_learnmore/radtutorial/chapter01_05.html; Internet; accessed 19 May 2004.

³⁶⁵ Steve Bowman, *Weapons of Mass Destruction: The Terrorist Threat* (Washington, D.C.: Congressional Research Service Report for Congress, 7 March 2002), 4; available from <http://www.fas.org/irp/crs/RL31332.pdf>; Internet; accessed 23 December 2002.

³⁶⁶ “Economic Effects,” *Introduction to Radiological Terrorism*, 1; available from

http://www.nti.org/h_learnmore/radtutorial/chapter02_02.html; Internet; accessed 19 May 2004.

³⁶⁷ Ken Silverstein, “David Hahn, Boy Atomic Scientist,” *ASEPCO*, [Originally printed in *Harpers’s Magazine*, November 1998]; available from http://www.asepco.com/David_Hahn_Boy_Scientist.htm; Internet; accessed 31 August 2004.

³⁶⁸ “Dirty Bombs: Response to a Threat,” FAS Public Interest Report, *The Journal of the Federation of American Scientists* vol 55 no2 (March/April 2002), 1-11; available from <http://www.fas.org/faspir/2002/v55n2/dirtybomb.htm>; Internet; accessed 15 April 2004.

explosion that dispersed radiological contamination in dust-like particles capable of being inhaled. Dust settling in the affected area, as well as contaminated food or water sources, could be vectors of potential radiation exposure. Any real incident of radiological contamination would cause significant disruption of social, medical, economic, fiscal, and governmental operations, compounded with overarching psychological trauma.

Attack on a nuclear facility is another means to cause radiological contamination. Even with the redundant safeguards and security measures at nuclear facility locations, the possibility of terrorist assault and breach of these measures is not impossible. Yet, considerable precautions and security measures are in effect to preclude successful attacks by vehicle borne explosive devices or aerial borne means. Although remote in expectation, the possibility of a member of a nuclear facility workforce negating facility safeguards and assisting a terrorist act receives constant review and evaluation.³⁶⁹

Although the 1986 Chernobyl accident at a nuclear power station in the Ukraine had no connection to terrorism, the resulting political, financial, and social impacts are profound and provide an illustration of what damage radiological contamination can cause. An 18-mile radius around the nuclear plant was closed to everyone except official teams, the large local city near the site was completely evacuated and abandoned. Evacuation numbers vary, however, between 400,000 people³⁷⁰ and 130,000³⁷¹ people were resettled to safe areas. Reports note that over 20 towns and 3000 settlements were affected by radiation doses of significance. Over 400 settlements had to be evacuated.³⁷² Over 30 people died from the accident while long-term effects on a regional population remain an open-ended issue. Health, economic, and agricultural impacts are still being assessed as various international programs deal with safety, decontamination, and stabilization of equipment, facilities, and the region at a growing cost in the hundreds of millions of dollars.³⁷³

The 1979 accident at Three Mile Island (TMI-2) is the most serious nuclear power plant accident in the United States to date. No terrorism was involved in this accident, but the incident highlights the potential for radiological disaster and psychological impact on a regional population. The plant experienced a partial core meltdown that could have breached the containment building and dispersed massive quantities of radiation into the environment.

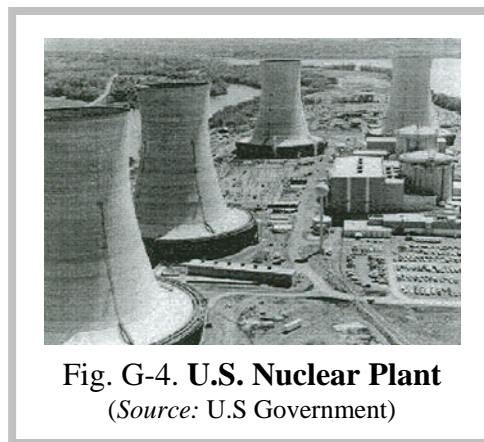

Fig. G-4. U.S. Nuclear Plant
(Source: U.S Government)

³⁶⁹ "Terrorists and Radiological Terrorism," *Introduction to Radiological Terrorism*, 2 and 3; available from http://www.nti.org/h_learnmore/radtutorial/chapter04_02.html; Internet; accessed 19 May 2004.

³⁷⁰ "History of the United Nations and Chernobyl," *The United Nations and Chernobyl*, 1; available from <http://www.un.org/ha/Chernobyl/>; Internet; accessed 1 July 2004.

³⁷¹ "Fact Sheet on the Accident at the Chernobyl Nuclear Power Plant," U.S. Nuclear Regulatory Commission, 1 to 4; available from <http://www.nrc.gov/reading-rm/doc-collections/fact-sheets/fschernobyl.html>; Internet; accessed 1 July 2004.

³⁷² "History of the Chernobyl disaster," 1 and 2; available from <http://www.Chernobyl.org.uk/page 2.htm>; Internet; accessed 30 June 2004.

³⁷³ "Fact Sheet on the Accident at the Chernobyl Nuclear Power Plant," U.S. Nuclear Regulatory Commission, 1 to 4; available from <http://www.nrc.gov/reading-rm/doc-collections/fact-sheets/fschernobyl.html>; Internet; accessed 1 July 2004.

Fortunately, this breach did not occur, even though a significant amount of radiation was released into the atmosphere. No death or injury occurred to plant workers or citizens of nearby communities during the Three Mile Island accident. Multiple government and independent studies conclude that most of the radiation was contained and what radiation was released caused negligible effects on the physical health of individuals or the environment. Nonetheless, the safety and cleanup operations have spanned decades with a corresponding major fiscal cost.³⁷⁴

Nuclear Weapons

The use of a fully developed nuclear weapon is a possible attack scenario but would require extraordinary terrorist financial and technical resources. A more likely scenario deals with nuclear material and sabotage or a siege-hostage situation at a nuclear facility.³⁷⁵ This type scenario aligns more correctly with a radiological incident. Nonetheless, the potential effects could be catastrophic to a surrounding area and population.

Some groups may have state sponsors that possess or can obtain nuclear weapons, but the CIA has no credible reporting at this time of terrorists successfully acquiring nuclear weapons or sufficient material to make them.³⁷⁶ However, since the collapse of the Soviet Union in 1989, there has been a growth in nuclear trafficking. It's believed that three shipments of Plutonium 239 intercepted by the German police in 1994 came from Russia.³⁷⁷ Since 1991, Russian authorities say there have been 23 attempts to steal fissile material, some of which have been successful. Intelligence officials believe enough nuclear material has left Russia to make a bomb.³⁷⁸ Public announcements of missing, stolen, or recovered fissile material in the last 15 years indicate a market for such critical material to make a crude nuclear weapon. Such material incidents range from less than .02 kilograms to several instances of 1 to 3 kilograms.³⁷⁹ The International Atomic Energy Agency (IAEA) notes that the significant amount of nuclear material required for the possible manufacturing of a nuclear explosive device, depending on the type material, can range from eight kilograms to 75 kilograms.³⁸⁰ As demonstrated in al Qaeda statements, when and if a terrorist group does obtain a nuclear weapon, attack with a nuclear weapon of mass destruction is a distinct possibility.

The size of most nuclear weapons makes them hard to clandestinely transport. Backpacks and images of "suitcase" nuclear bombs convey the concept of covertly delivering small nuclear weapons or dangerous radiological dispersion devices. The most likely means of transporting them would be via commercial shipping, such as trucks, vehicles, and ships.³⁸¹

³⁷⁴ "Fact Sheet on the Accident at Three Mile Island," U.S. Nuclear Regulatory Commission, 1 to 5; available from <http://www.nrc.gov/reading-rm/doc-collections/fact-sheets/3mile-isle.html>; Internet; accessed 1 July 2004.

³⁷⁵ *Encyclopedia of World Terrorism*, 1997 ed., s.v. "Nuclear."

³⁷⁶ Director of Central Intelligence, DCI Weapons Intelligence, Nonproliferation, and Arms Control Center, *Unclassified Report to Congress on the Acquisition of Technology Relating to Weapons of Mass Destruction and Advanced Conventional Munitions, 1 January Through 30 June 2001* (Washington, D.C., January 2002), 9.

³⁷⁷ *Encyclopedia of World Terrorism*, 1997 ed., s.v. "Nuclear."

³⁷⁸ Lewis M. Simons, "Weapons of Mass Destruction: An Ominous New Chapter Opens on the Twentieth Century's Ugliest Legacy," *National Geographic* 202, no. 5 (November 2002): 16.

³⁷⁹ Richard Rhodes, "Living With The Bomb," *National Geographic*, 208, No. 2 (August 2005): 104.

³⁸⁰ *IAEA Safeguards Glossary*, 2001 Edition, International Nuclear Verification Series No. 3, Table II, 23; available from <http://www-pub.iaea.org/MTCD/publications>; Internet; accessed 22 July 2005.

³⁸¹ Steve Bowman, *Weapons of Mass Destruction: The Terrorist Threat*, 4.

High Yield Explosives

High yield explosives are another significant threat for weapon effects of mass destruction or mass disruption. Terrorist targeting includes critical infrastructure and key assets, and can also aim at causing mass casualties. Terrorists are relentless and patient; they will seize on opportunity and can demonstrate flexibility in strategy and tactics. Attack may occur against a critical node, system, or function. Beyond the physical damage or destruction, attack may cause a cascading disruption for government, social order, and economics as the public and private sectors react. Intent may focus on damage to national prestige, morale, or confidence, as well as legitimate concerns of public health and safety.³⁸² An attack can also be exploited to assist in near-simultaneous or follow-on assault against separate targets.

Acts of terrorism using high yield explosives have been conducted by foreign and domestic terrorists against the United States. The incidents of the foreign terrorist bombing of the U.S. Embassy and Marine Barracks in Lebanon in 1983 and the domestic terrorist bombing of the Murrah Federal Building in Oklahoma City, Oklahoma in 1995 are well known examples.

In April 1983, a truck loaded with about 400 pounds of explosives rammed into the U.S. Embassy in Beirut, Lebanon. This suicidal attack killed 63 people, including 17 Americans.³⁸³ Eight members were employees of the Central Intelligence Agency. In October 1983, a suicide bomber detonated a truck full of explosives at a U.S. Marine Corps barracks located at Beirut International Airport. Casualties were 241 members of the U.S. Armed Services killed and more than 100 others wounded.³⁸⁴

In the United States, a domestic terrorist parked a truck bomb at the base of the Alfred P. Murrah Federal Building in April 1995, and casually detonated the truck bomb with a timed fuse. The high yield explosive was a relatively simple device using several thousand pounds of ammonium nitrate fertilizer, other materials, and explosives.³⁸⁵ The blast and immediate aftermath killed 168 men, women, and children; and injured over 800 other people. The explosion devastated a large area of downtown Oklahoma City, Oklahoma.

Another horrific example of a high yield explosive and mass destruction is the near-simultaneous suicidal attack on the World Trade Center and Pentagon in September 2001. Other logical considerations for large volume explosive material include commercial shipping, railroad transportation, and major storage facilities.

Availability and Dual Use

The basic knowledge needed to produce an effective weapon of mass destruction can be found in college and medical school textbooks, advanced engineering books, magazines and

³⁸² The National Strategy for the Physical Protection of Critical Infrastructures and Key Assets, viii.

³⁸³ "April 1983 US Embassy bombing," 1; available from <http://encyclopedia.thefreedictionary.com/April%201983%20US%20Embassy%20bombing>; Internet; accessed 1 July 2004.

³⁸⁴ "Terrorist attacks on Americans 1979-1988," 2; available from <http://www.pbs.org/wgbh/pages/frontline/shows/target/etc/cron.html>; Internet; accessed 1 July 2004.

³⁸⁵ Lou Michel and Dan Herbeck, *American Terrorist: Timothy McVeigh and the Oklahoma City Bombing* (New York: Harper Collins Publishers Inc., 2001), 164.

periodicals, and on the Internet. With minimal training, individuals can produce various types of CBRNE weapons with relative ease in any home, school, or university laboratory, medical production or research facility, or commercial production facility. Minimal special equipment, purchased on the open market, can produce certain biological or chemical weapons. Weapons production cost is low, compared to other types of weaponry. Some precursor agents for biological and chemical production are dual use, are not expensive, and are not illegal to acquire or possess. Of course, theft, false documentation, and other techniques can surmount many of the normal regulatory control procedures for obtaining restricted precursor materials, equipment, or production processes.

Distinguishing legitimate biological, medical, or commercial production plants from a weapons production facility proves very difficult. Chemical and biological agents can be produced in small laboratories with little or no signature to identify the facility or their production. Normal biological warfare research facilities resemble completely legitimate biotechnical and medical research facilities. The same production facilities that can produce biological warfare agents may also produce wine and beer, dried milk, food and agricultural products.

“When the spread of chemical and biological and nuclear weapons, along with ballistic missile technology – when that occurs, even weak states and small groups could attain catastrophic power to strike great nations. Our enemies have declared this very intention, and have been caught seeking these terrible weapons...”

“The targets of these attacks are our military forces and our civilian population.”

President Bush in The National Security Strategy of the United State of America

Biological agents are naturally occurring and relatively easy to obtain as compared to nuclear material. They can be obtained from universities or medical schools. Chemical agents and their precursors can be obtained from civilian agriculture sites, textile, plastic, or civilian chemical production facilities, or military research and military facilities. Terrorist access to these weapons can also be through a state sponsor or, given the increasing sophistication of terrorist groups, might be manufactured in laboratories they have established and financed.

Security limitations for weapons of mass destruction in the former Soviet Union provide a possible resource for terrorists to acquire radiological or nuclear weapons. Additionally, radioactive materials or waste can be purchased legally and misused, or obtained illegally through black market transactions. Substances can be obtained from governmental or civilian research and medical facilities such as power plants, construction sites, laboratories, or hospitals, or from military facilities concerned with the storage, production, and weaponization of these materials.

A general concern exists that some unemployed scientists or weapons experts from the former Soviet Union are willing to sell their knowledge and services to other countries. However, the former Soviet Union is not the only potential source of concern. There are many other sources available, to include the United States. Chemical plants, biological labs, food irradiation plants, medical x-ray labs, and nuclear reactors and waste repositories are examples on a much larger list of possible sources for obtaining radiological material.

Conclusion

A complex contemporary environment becomes even more complex as governments, nation-states, and non-state organizations grapple with the issues on weapons of mass destruction counterproliferation and nonproliferation, and a growing access to technology and delivery means. Nations around the world have expanding nuclear energy programs, biological business conglomerates, and chemical industries that remain susceptible to terrorist penetration and attack. Weapons related technologies are ever more available in a world market, sometimes sanctioned by legitimate government regulation and sometimes beyond the constraint of rational controls. Rogue states demonstrate the willingness to supply specific WMD-related technology and expertise to other countries, or in extraordinary unilateral decisionmaking, to supply similar WMD expertise to non-state actors.³⁸⁶

“Our enemies have openly declared that they are seeking weapons of mass destruction, and evidence indicates that they are doing so with determination.”

President Bush in The National Security Strategy of the United State of America

In the foreseeable near future, the U.S. military remains an essential capability to demonstrate national awareness and commitment of our citizenry and elected civilian leaders, global leadership, enhanced intelligence and analyses, scientific and technological superiority, and resolve to protect the national security interests of the United States.³⁸⁷ Several enabling functions stated in the U.S. *National Strategy to Combat Weapons of Mass Destruction* accent these priorities: intelligence collection and analysis on WMD, delivery systems, and related technologies; research and development to improve our ability to respond to evolving threats; bilateral and multilateral cooperation; and targeted strategies against hostile states and terrorists.

³⁸⁶ Director of Central Intelligence, DCI Weapons Intelligence, Nonproliferation, and Arms Control Center, *Unclassified Report to Congress on the Acquisition of Technology Reacting to Weapons of Mass Destruction and Advanced Conventional Munitions, 1 January Through 30 June 2003*, (Washington, D.C., January 2002), 11; available from http://www.cia.gov/cia/reports/721_reports/pdfs/jan_jun2003.pdf; Internet; accessed 19 May 2004.

³⁸⁷ Jon H. Moilanen, “Engagement and Disarmament: A U.S. National Security Strategy for Biological Weapons of Mass Destruction,” *Essays on Strategy XIII*. (Washington, D.C.; National Defense University, 1996), 141-182.

WMD is one of the most dangerous security issues that face the United States of America in the 21st Century. The three pillars of our *National Strategy to Combat Weapons of Mass Destruction* remains (1) counterproliferation, (2) nonproliferation, and (3) consequence management.³⁸⁸ The U.S. military and civilian organizations understand the threat of WMD and remain ready to defend the Nations' people and resources. The United States must continue efforts – with friends, allies, and adversaries – to deter and dissuade the acquisition and use of weapons of mass destruction. When appropriate, preemptive action may be warranted to deny acquisition to WMD capabilities.

³⁸⁸ The White House, National Security Presidential Directive 17 (NSPD-17), *National Strategy to Combat Weapons of Mass Destruction*, (Washington, D.C., December 2002), 2; available from <http://www.fas.org/irp/offdocs/nspd/nspd-17.html>; Internet; accessed 8 December 2003.

Page Intentionally Blank

Glossary

17 November: Revolutionary Organization 17 November based in Greece

AAIA: Aden-Abyan Islamic Army, a.k.a. Islamic Army of Aden (IAA) based in Yemen

ABB: Alex Boncayao Brigade based in the Philippines

ADCON: Administrative control, that is, exercise of authority in administration and support. See Appendix H of terrorism handbook. (JP 1-02)

ADF: Allied Democratic Forces based in Uganda and the Congo

AI: Ansar al-Islam, a.k.a. Partisans of Islam, Helpers of Islam, Supporters of Islam, Jund al-Islam, and Jaish Ansar al-Sunna based in Iraq

AIAI: Al-Ittihad al-Islami, a.k.a. Islamic Union based in Somalia

AIB: Anti-Imperialist International Brigade, a.k.a. Japanese Red Army (JRA) based in Lebanon and Japan

Al-Badhr: Al-Badhr Mujahidin based in Pakistan

ALF: Animal Liberation Front

ALIR: Army for the Liberation of Rwanda, a.k.a. Interahamwe, Former Armed Forces of Rwanda (ex-FAR)

anarchism: A political theory holding all forms of governmental authority to be unnecessary and undesirable and advocating a society based on voluntary cooperation and free association of individuals and groups. (Webster's)

ANO: Abu Nidal Organization, a.k.a. Fatah Revolutionary Council, Arab Revolutionary Brigades, Black September, and Revolutionary Organization of Socialist Muslims based in Iraq

anti-terrorism: (AT) (JP 1-02) — Defensive measures used to reduce the vulnerability of individuals and property to terrorist acts, to include limited response and containment by local military forces.

AOR: Area of responsibility

ASG: Abu Sayyaf Group based in the Philippines

asset (terrorist): A resource — person, group, relationship, instrument, installation, or supply — at the disposition of a terrorist organization for use in an operational or support role. Often used with a qualifying term such as suicide asset or surveillance asset. Based upon JP 1-02 asset (intelligence).

AUC: Autodefensas Unidas de Colombia, a.k.a. United Self-Defense Forces/Group of Colombia

AUM: Aum Supreme Truth, a.k.a. Aum Shinrikyo and Aleph based in Japan

backdoor: Used to describe a back way, hidden method, or other type of method of by passing normal computer security in order to obtain access to a secure area.

biological agent: (JP 1-02) — A microorganism that causes disease in personnel, plants, or animals or causes the deterioration of materiel.

biological weapon: (JP 1-02) — An item of materiel, which projects, disperses, or disseminates a biological agent including arthropod vectors.

bioregulators: (CBRN Handbook) Biochemicals that regulate bodily functions. Bioregulators that are produced by the body are termed "endogenous." Some of these same bioregulators can be chemically synthesized.

blister agents: (CBRN Handbook) Substances that cause blistering of the skin. Exposure is through liquid or vapor contact with any exposed tissue (eyes, skin, lungs).

blood agents: (CBRN Handbook) Substances that injure a person by interfering with cell respiration (the exchange of oxygen and carbon dioxide between blood and tissues).

BR/PCC: New Red Brigades/Communist Combatant Party, a.k.a. Brigade Rosse/Partito Comunista Combattente based in Italy

CBRNE: Chemical, biological, radiological, nuclear, and high yield explosive categories normally associated with weapons of mass destruction.

CFF: Cambodian Freedom Fighters, a.k.a. Cholana Kangtoap Serei Cheat Kampouchea based in Cambodia

chemical weapon: (JP 1-02) — Together or separately, (a) a toxic chemical and its precursors, except when intended for a purpose not prohibited under the Chemical Weapons Convention; (b) a munition or device, specifically designed to cause death or other harm through toxic properties of those chemicals specified in (a), above, which would be released as a result of the employment of such munition or device; (c) any equipment specifically designed for use directly in connection with the employment of munitions or devices specified in (b) above.

chemical agent: (CBRN Handbook) A chemical substance that is intended for use in military operations to kill, seriously injure, or incapacitate people through its physiological effects. Excluded from consideration are riot control agents, and smoke and flame materials. The agent may appear as a vapor, aerosol, or liquid; it can be either a casualty/toxic agent or an incapacitating agent.

choking agents: (CBRN Handbook) Substances that cause physical injury to the lungs. Exposure is through inhalation. In extreme cases, membranes swell and lungs become filled with liquid. Death results from lack of oxygen; hence, the victim is "choked."

CIRA: Continuity Irish Republican Army based in Northern Ireland

conflict: (Army) — A political-military situation between peace and war, distinguished from peace by the introduction of organized political violence and from war by its reliance on political methods. It shares many of the goals and characteristics of war, including the destruction of governments and the control of territory. See FM 100-20.

COCOM: Combatant command, that is, command authority. See page 247 footnote of handbook. (JP 1-02)

consequence management: Traditionally, consequence management has been predominantly an emergency management function and included measures to protect public health and safety, restore essential government services, and provide emergency relief to governments, businesses, and individuals affected by the consequences of terrorism. The requirements of consequence management and crisis management are combined in the NRP.

CONUS: Continental United States

counter-terrorism: (CT) (JP 1-02) — Offensive measures taken to prevent, deter, and respond to terrorism.

CPP/NPA: Communist Party of the Philippines/New People's Army based in the Philippines

crisis management: Traditionally, crisis management was predominantly a law enforcement function and included measures to identify, acquire, and plan the use of resources needed to anticipate, prevent, and/or resolve a threat or act of terrorism. The requirements of consequence management and crisis management are combined in the NRP.

cyber-terrorism: (FBI) — A criminal act perpetrated by the use of computers and telecommunications capabilities, resulting in violence, destruction and/or disruption of services to create fear by causing confusion and uncertainty within a given population, with the goal of influencing a government or population to conform to a particular political, social, or ideological agenda.

Defense Coordinating Officer: (DCO) The single point of contact at an incident management location for coordinating and validating the use of DOD resources. DCO works directly with the FCO or designated Federal representative, and coordinates request for assistance with the joint force commander, when a JTF is tasked to an incident response. See NRP.

Defense Information System Network: (DISN) The global, end-to-end information transfer infrastructure of DOD. It provides long haul data, voice, video, and transport networks and services needed for national defense command, control, communication, and intelligence requirements, as well as corporate defense requirements.

DSWA: Defense Special Weapons Agency

Defense Support of Civil Authorities: (DSCA) An emergent term under consideration for inclusion to the 2004 National Response Plan that incorporates the Department of Defense support to domestic emergencies, law enforcement, and other activities. A traditional overarching term is Military Assistance to Civil Authorities (MACA) which includes Military Support to Civil Authorities (MSCA) and Military Assistance to Law Enforcement (MACLEA). See NRP.

denial of service attack: (DOS) An attack designed to disrupt network service, typically by overwhelming the system with millions of requests every second causing the network to slow down or crash.

Designated Foreign Terrorist Organization: (DFTO) A political designation determined by the U.S. Department of State. Listing as a DFTO imposes legal penalties for membership, prevents travel into the U.S., and proscribes assistance and funding activities within the U.S. or by U.S. citizens. From *Patterns of Global Terrorism 2001*, U.S. Department of State.

DIRLAUTH: Direct liaison authorized

DFLP: Democratic Front for the Liberation of Palestine based in the Occupied Territories

DHS: Department of Homeland Security

DHKP/C: Revolutionary People's Liberation Party/Front, a.k.a. Devrimci Sol, Revolutionary Left, or Dev Sol based in Turkey

distributed denial of service attack: (DDOS) Similar to a denial of service attack, but involves the use of numerous computers to simultaneously flood the target.

Domestic Emergency Support Team: (DEST) See NRP.

dysfunctional state: Used in this circular to mean a nation or state whose declared government cannot fulfill one or more of the core functions of governance, such as defense, internal security, revenue collection, resource allocation, etc.

ELA: Revolutionary People's Struggle based in Greece

ELF: Earth Liberation Front

ELN: National Liberation Army based in Colombia

e-mail spoofing: A method of sending e-mail to a user that appears to have originated from one source when it actually was sent from another source.

Emergency Response Team: (ERT) See NRP.

ETA: Basque Fatherland and Liberty based in Spain

ETIM: Eastern Turkistan Islamic Movement based in China

FACT: Federation of Associations of Canadian Tamils, a.k.a. World Tamil Movement (WTM), World Tamil Association (WTA), Liberation Tigers of Tamil Eelam (LTTE), Ellalan Force, and Sangilian Force based in Sri Lanka

failed state: For the purposes of this circular, a dysfunctional state which also has multiple competing political factions in conflict within its borders, or has no functioning governance above the local level. This does not imply that a central government facing an insurgency is automatically a failed state. If essential functions of government continue in areas controlled by the central authority, it has not “failed.”

FALN: Fuerzas Armadas de Liberacion Nacional Puertorriquena, a.k.a. Armed Forces for Puerto Rican National Liberation

FARC: Revolutionary Armed Forces of Colombia

Federal Coordinating Officer: (FCO) A Federal representative who manages Federal resource support activities related to Stafford Act disasters and emergencies; supports and is subordinate to the Principle Federal Official (PFO) when one is designated by DHS.

FEMA: Federal Emergency Management Agency. See NRP.

force protection: Security program designed to protect Service members, civilian employees, family members, facilities, and equipment, in all locations and situations, accomplished through planned and integrated application of combating terrorism, physical security, operations security, personal protective services, and supported by intelligence, counterintelligence, and other security programs.

force protection condition (FPCON): There is a graduated series of Force Protection Conditions ranging from Force Protection Conditions Normal to Force Protection Conditions Delta. There is a process by which commanders at all levels can raise or lower the Force Protection Conditions based on local conditions, specific threat information and/or guidance from higher headquarters. The four Force Protection Conditions above normal are:

Force Protection Condition ALPHA--This condition applies when there is a general threat of possible terrorist activity against personnel and facilities, the nature and extent of which are unpredictable, and circumstances do not justify full implementation of Force Protection Conditions BRAVO measures. The measures in this Force Protection Conditions must be capable of being maintained indefinitely.

Force Protection Condition BRAVO--This condition applies when an increased and more predictable threat of terrorist activity exists. The measures in this Force Protection Conditions must be capable of being maintained for weeks without causing undue hardship, affecting operational capability, and aggravating relations with local authorities.

Force Protection Condition CHARLIE--This condition applies when an incident occurs or intelligence is received indicating some form of terrorist action against personnel and facilities is imminent. Implementation of measures in this Force Protection Conditions for more than a short period probably will create hardship and affect the peacetime activities of the unit and its personnel.

Force Protection Condition DELTA--This condition applies in the immediate area where a terrorist attack has occurred or when intelligence has been received that terrorist action against a specific location or person is likely. Normally, this Force Protection Conditions is declared as a localized condition.

FPM: Morzanist Patriotic Front based in Honduras

FPMR: Manuel Rodriguez Patriotic Front based in Chile

GIA: Armed Islamic Group based in Algeria

GICM: Moroccan Islamic Combatant Group based in Western Europe

Global Information Grid: (GIG) DOD's globally interconnected set of information capabilities, processes, and personnel for collecting, processing, storing, disseminating, and managing information on demand to warfighters, policymakers, and support personnel.

GRAPO: Grupo de Resistencia Anti-Fascista Premero de Octubre, a.k.a. First of October Antifascist Resistance Group based in Spain

GSPC: The Salafist Group for Call and Combat based in Algeria

guerrilla warfare: (JP 1-02, NATO) — Military and paramilitary operations conducted in enemy-held or hostile territory by irregular, predominantly indigenous forces. (See also unconventional warfare (UW)).

GWOT: Global war on terrorism

hacker: Advanced computer users who spend a lot of time on or with computers and work hard to find vulnerabilities in IT systems.

hactivist: These are combinations of hackers and activists. They usually have a political motive for their activities, and identify that motivation by their actions, such as defacing opponents' websites with counter-information or disinformation.

HIG: Hizb-I Islami Gulbuddin based in Afghanistan and Pakistan

Homeland Security Advisory System (HSAS): The advisory system provides measures to remain vigilant, prepared, and ready to deter terrorist attacks. The following Threat Conditions each represent an increasing risk of terrorist attacks. Beneath each Threat Condition are suggested protective measures, recognizing that the heads of Federal departments and agencies are responsible for developing and implementing appropriate agency-specific protective measures:

- **Low Condition (Green).** This condition is declared when there is a low risk of terrorist attacks. Federal departments and agencies should consider the following general measures in addition to the agency-specific Protective Measures they develop and implement: refining and exercising as appropriate preplanned Protective Measures; ensuring personnel receive proper training on the Homeland Security Advisory System and specific preplanned department or agency Protective Measures; and institutionalizing a process to assure that all facilities and regulated sectors are regularly assessed for vulnerabilities to terrorist attacks, and all reasonable measures are taken to mitigate these vulnerabilities.
- **Guarded Condition (Blue).** This condition is declared when there is a general risk of terrorist attacks. In addition to the Protective Measures taken in the previous Threat Condition, Federal departments and agencies should consider the following general measures in addition to the agency-specific Protective Measures that they will develop and implement: checking communications with designated emergency response or command locations; reviewing and updating emergency response procedures; and providing the public with any information that would strengthen its ability to act appropriately.
- **Elevated Condition (Yellow).** An Elevated Condition is declared when there is a significant risk of terrorist attacks. In addition to the Protective Measures taken in the previous Threat Conditions, Federal departments and agencies should consider the following general measures in addition to the Protective Measures that they will develop and implement: increasing surveillance of critical locations; coordinating emergency plans as appropriate with nearby jurisdictions; assessing

whether the precise characteristics of the threat require the further refinement of preplanned Protective Measures; and implementing, as appropriate, contingency and emergency response plans.

- **High Condition (Orange).** A High Condition is declared when there is a high risk of terrorist attacks. In addition to the Protective Measures taken in the previous Threat Conditions, Federal departments and agencies should consider the following general measures in addition to the agency-specific Protective Measures that they will develop and implement: coordinating necessary security efforts with Federal, State, and local law enforcement agencies or any National Guard or other appropriate armed forces organizations; taking additional precautions at public events and possibly considering alternative venues or even cancellation; preparing to execute contingency procedures, such as moving to an alternate site or dispersing their workforce; and restricting threatened facility access to essential personnel only.
- **Severe Condition (Red).** A Severe Condition reflects a severe risk of terrorist attacks. Under most circumstances, the Protective Measures for a Severe Condition are not intended to be sustained for substantial periods of time. In addition to the Protective Measures in the previous Threat Conditions, Federal departments and agencies also should consider the following general measures in addition to the agency-specific Protective Measures that they will develop and implement: increasing or redirecting personnel to address critical emergency needs; signing emergency response personnel and pre-positioning and mobilizing specially trained teams or resources; monitoring, redirecting, or constraining transportation systems; and closing public and government facilities.

HM: Hizb ul-Mujahidin based in Kashmir, India

HUA: Harakat ul-Ansar based in Pakistan

HUJI: Harakat ul-Jihad-I-Islami, a.k.a. Movement of Islamic Holy War based in Pakistan

HUJI-B: Harakat ul-Jihad-I-Islami/Bangladesh, a.k.a. Movement of Islamic Holy War based in Bangladesh

HUM: Harakat ul-Mujahidin, a.k.a. Movement of Holy Warriors, and Jamiat ul-Ansar (JUA) based in Pakistan

HUMINT: Human intelligence

IAA: Islamic Army of Aden, a.k.a. Aden-Abyan Islamic Army (AAIA) based in Yemen

IBDA-C: Great East Islamic Raiders – Front based in Turkey

IED: Improvised Explosive Device. Devices that have been fabricated in an improvised manner and that incorporate explosives or destructive, lethal, noxious, pyrotechnic, or incendiary chemicals in their design.

IG: Al-Gama'a al-Islamiyya, a.k.a. Islamic Group based in Egypt

IIPB: Islamic International Peacekeeping Brigade based in Chechnya

IMU: Islamic Movement of Uzbekistan based in Uzbekistan

incapacitating agent: (CBRN Handbook) Produce temporary physiological and/or mental effects via action on the central nervous system. Effects may persist for hours or days, but victims usually do not require medical treatment. However, such treatment speeds recovery.

Incident Command System (ICS): A standardized on-scene emergency management concept specifically designed to allow its user(s) to adopt an integrated organizational structure equal to the complexity and demands of single or multiple incidents without being hindered by jurisdictional boundaries. The national standard for ICS is provided by NIMS.

industrial agent: (CBRN Handbook) Chemicals developed or manufactured for use in industrial operations or research by industry, government, or academia. These chemicals are not primarily manufactured for the specific purpose of producing human casualties or rendering equipment, facilities, or areas dangerous for use by man. Hydrogen cyanide, cyanogen chloride, phosgene, chloropicrin and many herbicides and pesticides are industrial chemicals that also can be chemical agents.

INLA: Irish National Liberation Army based in Northern Ireland

INRP: Initial National Response Plan. As the time of this handbook publication, is a final draft document that consolidates several Federal-level incident management and emergency response plans into a national framework for domestic incident management.

insurgency: (JP 1-02, NATO) — An organized movement aimed at the overthrow of a constituted government through the use of subversion and armed conflict.

international: of, relating to, or affecting two or more nations (Webster's). For our purposes, affecting two or more nations.

IP address spoofing: A method that creates Transmission Control Protocol/Internet Protocol (TCP/IP) packets using somebody else's IP address

IRA: Irish Republican Army based in Northern Ireland

IMU: Islamic Movement of Uzbekistan

JEM: Jaish-e-Mohammed, a.k.a. Army of Mohammed based in Pakistan

JJ: Jemaah Islamiya based in Malaysia and Singapore

Joint Field Office: (JFO) See National Response Plan.

JRA: Japanese Red Army, a.k.a. Anti-Imperialist International Brigade (AIIB) based in Lebanon and Japan

JUA: Jamiat ul-Ansar, a.k.a. Harakat ul-Mujahidin (HUM), and Movement of Holy Warriors

JUD: Jamaat ud-Dawa, a.k.a. Lashkar-e-Tayyiba, and Army of the Righteous (LT) based in Pakistan

JUM: Jamiat ul-Mujahidin based in Kashmir, India

KADEK: Kurdistan Freedom and Democracy Congress, a.k.a. Kongra-Gel (KGK), Kurdistan Workers' Party (PKK), and Freedom and Democracy Congress of Kurdistan based in Turkey

keylogger: A software program or hardware device that is used to monitor and log each of the keys a user types into a computer keyboard.

KGK: Kongra-Gel, a.k.a. Kurdistan Workers' Party (PKK), Kurdistan Freedom and Democracy Congress (KADEK), and Freedom and Democracy Congress of Kurdistan based in Turkey

KMM: Kumpulan Mujahidin Malaysia based in Malaysia

LFA: Lead Federal Agency. See NRP.

LJ: Lashkar I Jhangvi, a.k.a. Army of Jhangvi based in Pakistan

logic bomb: A program routine that destroys data by reformatting the hard disk or randomly inserting garbage into data files.

LRA: Lord's Resistance Army based in Uganda

LT: Lashkar-e-Tayyiba, a.k.a. Army of the Righteous and Jamaat ud-Dawa (JUD) based in Pakistan

LTTE: Liberation Tigers of Tamil Eelam, a.k.a. World Tamil Association (WTA), World Tamil Movement (WTM), Federation of Associations of Canadian Tamils (FACT), Ellalan Force, and Sangilian Force based in Sri Lanka

LVF: Loyalist Volunteer Force based in Northern Ireland

MAGO: Muslims Against Global Oppression, a.k.a. Qibla and People Against Gangsterism and Drugs (PAGAD), and Muslims Against Illegitimate Leaders (MAIL) based in South Africa

MAIL: Muslims Against Illegitimate Leaders, a.k.a. Muslims Against Global Oppression (MAGO), and Qibla and People Against Gangsterism and Drugs (PAGAD) based in South Africa

MCC: The Maoist Communist Center, a.k.a. Naxalites and Maoist Communist Center of India (MCCI) based in India

MCCI: Maoist Communist Center of India, a.k.a. The Maoist Communist Center (MCC) and Naxalites based in India

MEK: Mujahidin-e Khalq Organization, a.k.a. Holy Warriors of the People, National Liberation Army of Iran (NLA), People's Mujahidin of Iran (PMOI), National Council of Resistance (NCR), National Council of Resistance of Iran (NCRI), and Muslim Iranian Student's Society based in Iraq

millenarian: Apocalyptic; forecasting the ultimate destiny of the world; foreboding imminent disaster or final doom; wildly unrestrained; ultimately decisive. (Merriam –Webster's)

MRTA: Tupac Amaru Revolutionary Movement based in Peru

narco-terrorism: (JP 3-07.4) Terrorism conducted to further the aims of drug traffickers. It may include assassinations, extortion, hijackings, bombings, and kidnappings directed against judges, prosecutors, elected officials, or law enforcement agents, and general disruption of a legitimate government to divert attention from drug operations.

nation: A community of people composed of one or more [nationalities](#) and possessing a more or less defined territory and government or a territorial division containing a body of people of one or more [nationalities](#) and usually characterized by relatively large size and independent status.

nation-state: A form of political organization under which a relatively homogeneous people inhabits a sovereign state; especially a state containing one as opposed to several nationalities.

NCR: National Council of Resistance, a.k.a. National Liberation Army of Iran (NLA), Mujahidin-e Khalq Organization (MEK), Holy Warriors of the People, People's Mujahidin of Iran (PMOI), National Council of Resistance of Iran (NCRI), and Muslim Iranian Student's Society based in Iraq

NCRI: National Council of Resistance of Iran, a.k.a. National Liberation Army of Iran (NLA), Mujahidin-e Khalq Organization (MEK), Holy Warriors of the People, People's Mujahidin of Iran (PMOI), National Council of Resistance (NCR), and Muslim Iranian Student's Society based in Iraq

nerve agents: (CBRN Handbook) Substances that interfere with the central nervous system. Exposure is primarily through contact with the liquid (skin and eyes) and secondarily through inhalation of the vapor. Three distinct symptoms associated with nerve agents are: pin-point pupils, an extreme headache, and severe tightness in the chest.

National Incident Management System: (NIMS). See *National Incident Management System* published by the Department of Homeland Security, 1 March 2004. The NIMS represents a core set of doctrine, concepts, principles, technology and organizational processes to enable effective, efficient, and collaborative incident

management. Nationwide context is an all-hazards, all jurisdictional levels, and multi-disciplines approach to incident management.

NIPR: Revolutionary Proletarian Initiative Nuclei based in Italy

NLA: National Liberation Army of Iran, a.k.a. Mujahidin-e Khalq Organization (MEK), Holy Warriors of the People, People's Mujahidin of Iran (PMOI), National Council of Resistance (NCR), National Council of Resistance of Iran (NCRI), and Muslim Iranian Student's Society based in Iraq

NPA: New People's Army based in the Philippines

National Response Plan (NRP): The *National Response Plan* (December 2004) is an all-discipline, all-hazards plan that establishes a single, comprehensive framework for the management of domestic incidents. It provides the structure and mechanisms for the coordination of Federal support to State, local, and tribal incident managers and for exercising direct Federal authorities and responsibilities.

NTA: Anti-Imperialist Territorial Nuclei based in Italy

nuclear weapon: (JP 1-02) — A complete assembly (i.e., implosion type, gun type, or thermonuclear type), in its intended ultimate configuration which, upon completion of the prescribed arming, fusing, and firing sequence, is capable of producing the intended nuclear reaction and release of energy.

OPCON: Operational control, that is, transferable command authority. See Appendix H of terrorism handbook. (JP 1-02).

operations security: (OPSEC) A process of identifying critical information and subsequently analyzing friendly actions attendant to military operations and other activities to: a. Identify those actions that can be observed by adversary intelligence systems. b. Determine indicators hostile intelligence systems might obtain that could be interpreted or pieced together to derive critical information in time to be useful to adversaries. c. Select and execute measures that eliminate or reduce to an acceptable level the vulnerabilities of friendly actions to adversary exploitation. Also called OPSEC. (Joint Pub 1-02)

OV: Orange Volunteers based in Northern Ireland

PAGAD: Qibla and People Against Gangsterism and Drugs, a.k.a. Muslims Against Global Oppression (MAGO), and Muslims Against Illegitimate Leaders (MAIL) based in South Africa

Pathogen: (CBRN Handbook) Any organism (usually living) capable of producing serious disease or death, such as bacteria, fungi, and viruses

PFLP: The Popular Front for the Liberation of Palestine based in Syria

PFLP-GC: The Popular Front for the Liberation of Palestine – General Command based in Syria

physical security: That part of security concerned with physical measures designed to safeguard personnel; to prevent unauthorized access to equipment, installations, material and documents; and to safeguard them against espionage, sabotage, damage, and theft. (Joint Pub 1-02)

PIJ: The Palestine Islamic Jihad based in Syria

PIRA: Provisional Irish Republican Army based in Northern Ireland

PKK: Kurdistan Workers' Party, a.k.a. Kongra-Gel (KGK), Kurdistan Freedom and Democracy Congress (KADEK), and Freedom and Democracy Congress of Kurdistan based in Turkey

PLF: Palestine Liberation Front based in Iraq

PMOI: People's Mujahidin of Iran, a.k.a. National Liberation Army of Iran (NLA), Mujahidin-e Khalq Organization (MEK), Holy Warriors of the People, National Council of Resistance (NCR), National Council of Resistance of Iran (NCRI), and Muslim Iranian Student's Society based in Iraq

Principle Federal Official: (PFO) Senior representative of Secretary of Homeland Security and lead Federal official on-scene to coordinate Federal domestic incidents management and resource allocation on-scene. See NRP.

PWG: Peoples War Group, a.k.a. Peoples War and Naxalites based in India

Radiological Dispersal Device: (RDD) (CBRN Handbook) A device (weapon or equipment), other than a nuclear explosive device, designed to disseminate radioactive material in order to cause destruction, damage, or injury by means of the radiation produced by the decay of such material.

Radiological Emitting Device: (RED) A device designed to disseminate radioactive material in order to cause destruction, damage, or injury by means of the radiation produced by the decay of such material. RED dissemination techniques can include intense, short duration exposure or progressive, long term exposure to radiation.

radiological operation: (JP 1-02) — The employment of radioactive materials or radiation producing devices to cause casualties or restrict the use of terrain. It includes the intentional employment of fallout from nuclear weapons.

RIRA: Real IRA, a.k.a. True IRA based in Northern Ireland

RHD: Red Hand Defenders based in Northern Ireland

RN: Revolutionary Nuclei based in Greece

RSRSBCM: Riyadus-Salikhin Reconnaissance and Sabotage Battalion of Chechen Martyrs based in Chechnya

RUF: Revolutionary United Front based in Sierra Leone

setback: Distance between outer perimeter and nearest point of buildings or structures within. Generally referred to in terms of explosive blast mitigation.

SL: Sendero Luminoso, a.k.a. Shining Path based in Peru

sniffer: A program and/or device that monitors data traveling over a network.

SPIR: Special Purpose Islamic Regiment based in Chechnya

SSP: Sipah-I-Sahaba/Pakistan based in Pakistan

state: A politically organized body of people usually occupying a definite territory; especially one that is sovereign.

steganography: The process of hiding information by embedding messages within other, seemingly harmless messages. The process works by replacing bits of useless or unused [data](#) in regular computer [files](#) (such as graphics, sound, text) with bits of different, invisible information. This hidden information can be [plain text](#), [cipher text](#), or even images.

TACON: Tactical control, that is, command authority with detailed limitations and responsibilities inherent to operational control. See Appendix H of terrorism handbook. (JP 1-02).

TCG: The Tunisian Combatant Group, a.k.a. The Tunisian Islamic Fighting Group or Jama'a Combattante Tunisienne based in Tunisia

terror tactics: Given that the Army defines tactics as “the art and science of employing available means to win battles and engagements,” then terror tactics should be considered “the art and science of employing violence, terror and intimidation to inculcate fear in the pursuit of political, religious, or ideological goals.”

terrorism: (JP 1-02) — The calculated use of violence or threat of violence to inculcate fear; intended to coerce or to intimidate governments or societies in the pursuit of goals that are generally political, religious, or ideological.

terrorist: (JP 1-02) — An individual who uses violence, terror, and intimidation to achieve a result.

terrorist goals: The term *goals* will refer to the strategic end or end state that the terrorist objectives are intended to obtain. Terrorist organization goals equate to the strategic level of war as described in FM 101-5-1.

terrorist group: Any group practicing, or that has significant subgroups that practice, international terrorism (U.S. Dept of State)

terrorist objectives: The standard definition of *objective* is – “The clearly defined, decisive, and attainable aims which every military operation should be directed towards” (JP 1-02). For the purposes of this work, terrorist objectives will refer to the intended outcome or result of one or a series of terrorist operations or actions. It is analogous to the tactical or operational levels of war as described in FM 101-5-1.

toxic chemical agent: (CBRN Handbook) Produce incapacitation, serious injury, or death. They can be used to incapacitate or kill victims. These agents are the choking, blister, nerve, and blood agents.

toxin agent: (JP 1-02) — A poison formed as a specific secretion product in the metabolism of a vegetable or animal organism, as distinguished from inorganic poisons. Such poisons can also be manufactured by synthetic processes.

transnational: Extending or going beyond national boundaries (Webster’s). In this context, not limited to or centered within a single nation.

trojan horse: A program or utility that falsely appears to be a useful program or utility such as a screen saver. However, once installed performs a function in the background such as allowing other users to have access to your computer or sending information from your computer to other computers.

virus: A software program, script, or macro that has been designed to infect, destroy, modify, or cause other problems with a computer or software program.

UDA/UFF: Ulster Defense Association/Ulster Freedom Fighters based in Northern Ireland

underground: A covert unconventional warfare organization established to operate in areas denied to the guerrilla forces or conduct operations not suitable for guerrilla forces.

unified command: As a term in the Federal application of the Incident Command System (ICS), defines agencies working together through their designated Incident Commanders at a single Incident Command Post (ICP) to establish a common set of objectives and strategies, and a single Incident Action Plan. This is NOT “unified command” as defined by the Department of Defense.

UVP: Ulster Defense Force based in Northern Ireland

UXO: Unexploded ordnance

VBIED: Vehicle borne improvised explosive device

WOT: War on terrorism

WTA: World Tamil Association, a.k.a. Liberation Tigers of Tamil Eelam (LTTE), World Tamil Movement (WTM), Federation of Associations of Canadian Tamils (FACT), Ellalan Force, and Sangilian Force based in Sri Lanka

WTM: World Tamil Movement, a.k.a. World Tamil Association (WTA), Liberation Tigers of Tamil Eelam (LTTE), Federation of Associations of Canadian Tamils (FACT), Ellalan Force, and Sangilian Force based in Sri Lanka

WCOTC: World Church of the Creator

WEG: Worldwide Equipment Guide. A document produced by the TRADOC ADCSINT – Threats that provides the basic characteristics of selected equipment and weapons systems readily available for use by the OPFOR.

WMD: (JP 1-02) — Weapons of Mass Destruction. Weapons that are capable of a high order of destruction and/or of being used in such a manner as to destroy large numbers of people. Weapons of mass destruction can be high explosives or nuclear, biological, chemical, and radiological weapons, but exclude the means of transporting or propelling the weapon where such means is a separable and divisible part of the weapon.

WMD-CST: Weapons of Mass Destruction – Civil Support Team

WMD/E: Weapons of mass destruction or effect is an emergent term referenced in the 2004 U.S. National Military Strategy to address a broader range of adversary capabilities with potentially devastating results.

worm: A destructive software program containing code capable of gaining access to computers or networks and once within the computer or network causing that computer or network harm by deleting, modifying, distributing, or otherwise manipulating the data.

zombie: A computer or server that has been basically hijacked using some form of malicious software to help a hacker perform a Distributed Denial Of Service attack (DDOS).

Selected Bibliography

- ABCNews.com, 18 October 2000. Available from <http://www.abcnews.go.com/world/DailyNews/cole001018b.html>; Internet; Accessed 9 January 2003.
- “Abu Nidal.” *Encyclopedia of the Orient*. Available from http://i-cias.com/e.o/abu_nidal.htm; Internet; Accessed 24 February 2004.
- “Abu Nidal Organization.” *Terrorism Questions and Answers*. Available from <http://cfrterrorism.org/groups/abunidal.html>. Internet; Accessed 24 February 2004.
- “Abu Nidal Organization (ANO).” *FAS Intelligence Resource Program*. Available from <http://www.fas.org/irp/world/para/ano.htm>; Internet; Accessed 24 February 2004.
- “April 1983 US Embassy bombing.” Available from <http://encyclopedia.thefreedictionary.com/April%201983%20US%20Embassy%20bombing>; Internet; Accessed 1 July 2004
- Albright, David. “Al Qaeda’s Nuclear Program: Through the Window of Seized Documents.” *Policy Forum Online* 47 (6 November 2002): 1-12. Available from http://www.nautilus.org/fora/Special-Policy-Forum/47_Albright.html; Internet; Accessed 13 February 2003.
- Anderson, Sean K., and Stephen Sloan. *Historical Dictionary of Terrorism*. Lanham, MD: Scarecrow Press, Inc, 2002.
- AR 190-52. *Countering Terrorism and Other Major Disruptions on Military Installations*. 1978.
- Aras, Djanguir. *Militant 2000: World Handbook on Non-governmental Militarized Structures*. Baku: Center for Low Intensity Conflict Studies, 2000.
- Army War College, *How The Army Runs; A Senior Leader Reference Handbook 2003-2004*. Carlisle, PA: U.S. Army War College, Department of Command, Leadership, and Management, 23 September 2003. Available at <http://carlisle-www.army.mil/usawc/dclm/linkedtextchapters.htm>; Internet; Accessed 31 December 2003.
- Arquilla, John and David Ronfeldt, ed. *Networks and Netwars*. Santa Monica: RAND, 2001.
- Ashcroft, John. “Remarks of Attorney General John Ashcroft, Indictment for the Bombing of the U.S.S. Cole.” Washington, D.C., 15 May 2003. Available from <http://www.usdoj.gov/ag/speeches/2003/051503agremarksucccole.htm>; Internet; Accessed 19 February 2004.
- Associated Press Newswires*. 12 February 2002. Available from http://www.Stop_eco_violence.org/pdfs/2_12_02.pdf; Internet; Accessed 17 January 2003.
- “Attack on the USS Cole.” Yemen Gateway. Available from <http://www.al-bab.com/yeman/cole1.htm>; Internet; Accessed 6 April 2004.
- Axtman, Kris. “The Terror Threat At Home, Often Overlooked.” *Christian Science Monitor*, 29 December 2003. Available at <http://ebird.afis.osd.mil/ebfiles/s20031229244982.html>; Internet; Accessed 29 December 2003.
- “2002 Bali Terrorist Bombing.” *Wikipedia*, 2004 ed., s.v. Available from http://en.wikipedia.org/wiki.phtml?title=2002_Bali_terrorist_bombing&printable=yes; Internet; Accessed 17 March 2004.
- The Basics of Terrorism: Parts 1-6*. The Terrorism Research Center, 1997. Available from <http://www.terrorism.com/terrorism/bpart1.html> through /bpart6.html; Internet; Accessed 29 August 2002.
- BBC News*, 21 December 1998. Available from http://news.bbc.co.uk/1/hi/special_report/1998/12/98/lockerbie/235632.stm; Internet; Accessed 12 December 2002.

- Beyler, Clara. "Messengers of Death – Female Suicide Bombers." *International Policy Institute for Counterterrorism* (12 February 2003): 3. Available from <http://www.ict.org.il/articles/articledet.cfm?articleid=470>; Internet; Accessed 18 March 2004.
- _____. "Female Suicide Bombers – An Update." *International Policy Institute for Counterterrorism* 7 March 2004: 1. Available from <http://www.ict.org.il/articles/articledet.cfm?articleid=508>; Internet; Accessed 31 March 2004.
- Billingslea, William. "Illicit Cigarette Trafficking and the Funding of Terrorism." *The Police Chief*, February 2004. 49-54.
- Black, Cofer. "The International Terrorism Threat," Testimony before the House International Relations Committee, Subcommittee on International Terrorism, Nonproliferation, and Human Rights. Washington, D.C., 26 March 2003; 6. Available from <http://www.state.gov/s/ct/rls/rm/2003/19136.htm>; Internet; Accessed 21 April 2005.
- Blythe, Will. "A Weatherman in Autumn." *Newsweek: Arts & Opinion*, 12 June 2003. Available from <http://msnbc.msn.com/id/3069267/>; Internet; Accessed 12 February 2004.
- Bolkcom, Christopher, Bartholomew Elias, and Andrew Feickert. *Homeland Security: Protecting Airliners from Terrorist Missiles*. Washington, D.C.: Congressional Research Service Report for Congress, November 3, 2003. Available from <http://www.fas.org/irp/crs/RL31741.pdf>; Internet; Accessed 1 April 2004.
- Bowman, Steve. *Homeland Security: The Department of Defense's Role*. Congressional Research Service Report for Congress, Order Code RL 31615, 7, 14 May 2003.
- _____. *Weapons of Mass Destruction: The Terrorist Threat*. Washington, D.C.: Congressional Research Service Report for Congress, 7 March, 2002. Available from <http://www.fas.org/irp/crs/RL31332.pdf>; Internet; Accessed 23 December 2002.
- Bryan, Major General James D. See U.S. Congress.
- Burghardt, Tom. "Leaderless Resistance and the Oklahoma City Bombing." BACORR: Bay Area Coalition for Our Reproductive Rights. Available from <http://nwcitizen.com/publicgood/reports/leadless.htm>; Internet; Accessed 10 February 2004.
- Burke, Jason. "You Have to Kill in the Name of Allah until You are Killed." *Guardian Unlimited Observer Special Report*, 27 January 2002: 1-6. Available from <http://www.observer.co.uk/islam/story/0,1442,640288,00.html>; Internet; Accessed 15 January 2003.
- Buse, Margaret. "Non-State Actors and Their Significance." *Journal of Mine Action* (December 2002): 1-9. Available from http://maic.jmu.edu/journal/5.3/features/maggie_buse_nsa/maggie_buse.htm; Internet; accessed 13 December 2002.
- "CAMERA ALERT: CBS' 60 Minutes Exposes. "The Arafat Papers." Available from http://www.camera.org/index.asp?x_article=289&x_context=3; Internet; Accessed 2 February 2004.
- Canadian Security Intelligence Service. "Report 2000/05 Biological Weapons Proliferation." *Perspectives* (9 June 2000): 1-8. Available from http://www.csis-scrs.gc.ca/eng/miscdocs/200005_e.html; Internet; Accessed 6 February 2003.
- Carr, Caleb. *The Lessons of Terror: A History of Warfare Against Civilians: Why it has Always Failed and Why it will Fail Again*. New York: Random House, 2002.
- Carr, Caleb. "TIME.com Interview with Calib Carr." 1 February 2002. Available at <http://www.time.com/time/2002/carr/interview.html>; Internet; Accessed 31 August 2004.

- CBS News.com, 21 January 2003. Available from <http://www.cbsnews.com/stories/2003/01/21/attack/main537258.shtml>; Internet; Accessed 10 February 2003.
- CBS News.com. "Evidence Points to Yemen Terror Attack." Available from <http://www.cbsnews.com/stories/2002/10/06/world/main524488.shtml>; Internet; Accessed 21 January 2004.
- Central Intelligence Agency. Director of Central Intelligence. *Cyber Threat Trends and U.S. Network Security*. Statement for the Record for the Joint Economic Committee by Lawrence K. Gershwin, National Intelligence Officer for Science and Technology. (Washington, D.C., 21 June 2001), 1. Available from http://www.cia.gov/cia/public_affairs/speeches/2001/gershwin_speech_06222001.html; Internet; Accessed 14 April 2004.
- Chalk, Peter. "Threats to the Maritime Environment: Piracy and Terrorism." RAND Stakeholder Consultation briefing presented at Ispra, Italy 28-30 October 2002. Available from <http://www.rand.org/randeurope/news/seacurty/piracyterrorism.chalk.pdf>; Internet; Accessed 4 April 2004.
- "Chemistry 101': The Make-up and Importance of Radioisotopes." *Introduction to Radiological Terrorism*, 1. Available from http://www.nti.org/h_learnmore/radtutorial/chapter01_03.html; Internet; Accessed 19 May 2004.
- Chester, Steven A. See U.S. Department of Defense.
- Chetak's Explosive Pages. Chetak's Website, 2002. Available from <http://www.geocities.com/chetak74/explosives.html>; Internet; Accessed 11 December 2002.
- "Chinese Satellite TV Hijacked by Falun Gong Cult." *People's Daily Online*, 9 July 2002. Available from http://english.peopledaily.com.cn/200207/08/eng20020708_99347.shtml; Internet; Accessed 27 Nov 2002.
- CJCS CONPLAN 0500-98. *Military Assistance to Domestic Consequence Management Operations in Response to a Chemical, Biological, Radiological, Nuclear, or High-Yield Explosive Situation*. 11 February 2002.
- CJCSI 3125.01. *Military Assistance to Domestic Consequence Management Operations in Response to a Chemical, Biological, Radiological, Nuclear, and High-Yield Explosive Situation*. 3 August 2001.
- Clark, C.J. *Mine/UXO Assessment: Former Yugoslav Republic of Macedonia*. New York: United Nations Mine Action Coordination Center, 8 October 2001. Available from http://www.mineaction.org/sp/mine_awareness_refdocs.cfm?doc_ID=707; Internet; Accessed 13 December 2002.
- CNN.com, 10 October 1995. Available from <http://www.cnn.com/US/9510/amtrak/10-10/>; Internet; Accessed 15 January 2003.
- CNN.com International, "Fuel rod parts missing from nuclear plant," 22 April 2004. Available from <http://edition.cnn.com/2004/US/Northeast/04/21/nuclear.fuel.missing.ap/index.html>; Internet; Accessed 22 April 2004.
- CNN.com LAW CENTER, 10 August 2004. "Terry Nichols Gets Life, No Parole." Available on <http://www.cnn.com/2004/LAW/08/09/Nichols.sentence.ap/>; Internet; Accessed 25 August 2004.
- CNN.com. WORLD, 22 November 2002. "Fishing Boat Explodes Near Israeli Vessel." Available from <http://www.cnn.com/2002/WORLD/meast/11/22/mideast/>; Internet; Accessed 21 January 2004.
- CNN.com, WORLD, 26 April 2004. "Jordan says major al Qaeda plot disrupted." Available from <http://www.cnn.com/2004/WORLD/meast/04/26/jordan.terror>; Internet; Accessed 9 August 2005.
- CNN.com, World-Middle East, 13 December 2000. "Yemen Names 6 Suspects in USS Cole Bombing." Available at <http://www.cnn.com/2000/WORLD/meast/12/13/yemen.cole.ap/>; Internet; Accessed 26 April 2004.

- CNS News.com, 3 December 2002. Available from <http://www.cnsnews.com/ForeignBureaus/archive/200212/FOR20021203a.html>; Internet; Accessed 19 March 2004.
- Cohen, William S. See U.S. Department of Defense.
- Coleman, Kevin. "Cyber Terrorism," *Directions Magazine*, 10 October 2003. Available from http://www.directionsmag.com/article.php?article_id=432; Internet; Accessed 15 March 2004.
- Colonel James "Nick" Rowe. Psychological Operations Website, n.d. Available from <http://www.psywarrior.com/rowe.html>; Internet; Accessed 7 January 2003.
- Committee on the Judiciary Subcommittee on Crime. Opening Statement by Louis J. Freech, Director, Federal Bureau of Investigation Before the Committee on the Judiciary Subcommittee on Crime. 104th Congress, 3 May 1995. Available from <http://www.lectlaw.com/files/cur13.htm>; Internet; Accessed 5 March 2004.
- Conventional Terrorist Weapons*. New York: United Nations Office for Drug Control and Crime Prevention, 2002. Available from http://www.undcp.org/odccp/terrorism_weapons_conventional.html; Internet; Accessed 12 November 2002.
- Corpus, Victor N. "The Invisible Army." Briefing presented at Fort Leavenworth, KS, 5 November 2002. TRADOC ADCSINT-Threats Files, Fort Leavenworth, KS.
- Crenshaw, Martha. "The Logic of Terrorism: Terrorist Behavior as a Product of Strategic Choice." In *Origins of Terrorism: Psychologies, Ideologies, Theologies, States of Mind*, rev. ed., edited by Walter Reich. Washington: Woodrow Wilson Center Press, 1998.
- Cyber-Terrorism*. Statement by Major General James D. Bryan, U.S. Army Commander, Joint task Force-Computer Network Operations, U.S. Strategic Command and Vice Director, Defense Information Systems Agency. Washington, D.C., 24 July 2003, 5. Available from <http://www.defenselink.mil/search97/s97is.vts?Action=FilterSearch&Filter=dl.hts&query=cyber-terrorism>; Internet; Accessed 6 April 2004.
- DA Pamphlet 550-104. *Human Factors Considerations of Undergrounds in Insurgencies*, September 1966.
- "Defense Information System Network." Defense Information Systems Agency, Network Services [Website on line, n.d.]. Available from <http://www.disa.mil/ns/gig.html>; Internet; Accessed 7 April 2004.
- Defense Threat Reduction Agency. *Domestic WMD Incident Management Legal Deskbook*, 3-12 and 3-13, December 2003. Available at <http://biotech.law.lsu.edu/blaw/DOD/manual>; Internet; Accessed 23 April 2004.
- Director of Central Intelligence, DCI Weapons Intelligence, Nonproliferation, and Arms Control Center. *Unclassified Report to Congress on the Acquisition of Technology Reacting to Weapons of Mass Destruction and Advanced Conventional Munitions, 1 January Through 30 June 2003*, 11. Available from http://www.cia.gov/cia/reports/721_reports/pdfs/jan_jun2003.pdf; Internet; Accessed 19 May 2004.
- "Dirty Bombs: Response to a Threat." FAS Public Interest Report, *The Journal of the Federation of American Scientists* 55 no. 2 (March/April 2002), 1-11. Available from <http://www.fas.org/faspir/2002/v55n2/dirtybomb.htm>; Internet; Accessed 15 April 2004.
- Dobson, Christopher, and Ronald Payne. *The Terrorist: Their Weapons, Leaders, and Tactics*. New York: Facts on File, Inc, Revised Edition, 1982.
- DOD Directive 3025.1, *Military Support to Civil Authorities* (MSCA), 15 January 1993.
- DOD Directive 3025.12, *Military Assistance for Civil Disturbances* (MACDIS), 4 February 1994.

DOD Directive 3025.15, *Military Assistance to Civil Authorities*, 18 February 1997.

Dolar, Lou. "Cell Phones Jury-rigged to Detonate Bombs." *Newsday.com*, 15 March 2004. Available from <http://www.newsday.com/news/nationworld/ny-wocell153708827mar15,0,1644248.story?coll=ny-nationworld-headlines>; Internet; Accessed 15 March 2004.

"Economic Effects." *Introduction to Radiological Terrorism*, 1. Available from http://www.nti.org/h_learnmore/radtutorial/chapter02_02.html; Internet; Accessed 19 May 2004.

Ehrenfeld, Rachael. *IRA + PLO + Terror*. Journal on-line. American Center for Democracy (ACD), 21 August 2002. Available from <http://public-integrity.org/publications21.htm>; Internet; Accessed 13 February 2004.

"Eligible Receiver." *Global Security.org*, 9 June 2002. Available from <http://www.globalsecurity.org/military/ops/eligible-receiver.htm>; Internet; Accessed 24 June 2004.

Ellis, John. "In My Humble Opinion: Genomics is the Most Economic, Political, and Ethical Issue Facing Mankind." *Fast Company*, November 1999. Available from <http://www.fastcompany.com/online/29/jellis.html>; Internet; Accessed 26 February 2004.

"Fact Sheet on the Accident at the Chernobyl Nuclear Power Plant." U.S. Nuclear Regulatory Commission, 1. Available at <http://www.nrc.gov/reading-rm/doc-collections/fact-sheets/fschernobyl.html>; Internet; Accessed 1 July 2004.

"Fact Sheet on the Accident at Three Mile Island." U.S. Nuclear Regulatory Commission, 1 to 5. Available at <http://www.nrc.gov/reading-rm/doc-collections/fact-sheets/3mile-isle.html>; Internet; Accessed 1 July 2004.

Falkenrath, Richard A. "Problems of Preparedness: US Readiness for a Domestic Terror Attack." *International Security* 25, no. 4 (Spring 2001): 147-186.

"False Calls on Casualties Upset Camp Pendleton Spouses." *Mustang Daily Online News*, 11 April 2003. Available from <http://www.mustangdaily.calpoly.edu/archive/20030411/print.php?story=inat>; Internet; Accessed 13 August 2004.

Fischer, Lynn F. *The Threat Of Domestic Terrorism*. The Terrorism Research Center, 2002. Available from <http://www.terrorism.com/terrorism/DomesticThreat.shtml>; Internet; Accessed 10 September 2002.

FM 1. *The Army*. June 2005

FM 1-02 (FM 101-5-1)(MCRP 5-12A) *Operational Terms and Graphics*. September 2004

FM 3-06. *Urban Operations*. June 2003.

FMI 3-07.22. *Counterinsurgency Operations*. October 2004 (Expires October 2006)

FM 3-23.30. *Grenades and Pyrotechnic Signals*. September 2000.

FM 5-0 (FM 101-5). *Army Planning and Orders Production*. January 2005.

FM 5-25. *Explosives and Demolitions*. March 1986.

FM 7-100. *Opposing Force Doctrinal Framework and Strategy*. May 2003.

FM 20-32. *Countermine Operations*. October 2002.

FM 100-37. *Terrorism Counteraction*. July 1987.

Ford, Franklin L. *Political Murder: From Tyrannicide to Terrorism*. Cambridge: Harvard University Press, 1985.

- Frances, Sabil. "Uniqueness of LTTE's Suicide Bombers." *Institute of Peace and Conflict Studies*, Article no. 321 (4 February 2000): 1. Available from <http://www.ipcs.org>; Internet; Accessed 7 September 2002.
- Franks, Tommy. "General Tommy Franks Testimony on USS Cole." Washington, D.C., 25 October 2000. Available from <http://www.fas.org/man/dod-101/sys/ship/docs/man-sh-ddg51-001025zd.htm>; Internet; Accessed 5 April 2004.
- Freeh, Louis. *See* Committee on the Subcommittee on Crime.
- "French Tanker Explosion Confirmed as Terror Attack." Available from <http://www.ict.org.il/spotlight/det.cfm?id=837>; Internet; Accessed 21 January 2004.
- Freund, Charles Paul. "Old School Osama: What We Found While Looking for Bin Laden." *Reason Online* 12 September 2002: 1-7. Available from <http://reason.com/hod/cpf091202.shtml>; Internet; Accessed 12 September 2002.
- Frittelli, John F. Port and Maritime Security: Background and Issues for Congress. Washington, D.C.: Congressional Research Service Report for Congress, December 5, 2003. Available from http://www.usembassy.at/en/download/pdf/port_sec.pdf; Internet; Accessed 5 April 2004.
- "From Push to Shove." *Southern Poverty Law Center Intelligence Report*, no. 107 (Fall 2002): 1-18. Available from <http://www.splcenter.org/intelligenceproject/ip-index.html>; Internet; Accessed 17 January 2003.
- Fuller, Fred L. "New Order Threat Analysis: A Literature Survey." *Marine Corps Gazette*, 81 (April 1997): 46-48.
- Garamone, Jim. *See* U.S. Department of Defense.
- Gellman, Bartom. "Cyber-Attacks by Al Qaeda Feared," *Washingtonpost.com*, 27 June 2002. Available from <http://www.washingtonpost.com/ac2/wp-dyn/A50765-2002Jun26>; Internet; Accessed 12 April 2004.
- "Global Information Grid." Defense Information Systems Agency, Network Services Website on line, n.d. Available from <http://www.disa.mil/ns/gig.html>; Internet; Accessed 7 April 2004.
- Gorin, Stuart. "Timothy McVeigh Executed for Oklahoma City Bombing." Washington File Staff Writer; U.S. Department of State International Information Programs. 11 June 2001. Available from <http://usinfo.state.gov/topical/pol/terro/01061101.htm>; Internet; Accessed 16 February 2004.
- Gray, Colin S. "Thinking Asymmetrically in Times of Terror." *Parameters* (Spring, 2002): 5-14.
- Greenberg, Maurice R., Chair; William F. Wechsler, and Lee S. Wolosky, Project Co-Directors. *Terrorist Financing: Report of an Independent Task Force Sponsored by the Council on Foreign Relations*. New York: Publication Office, Council on Foreign Relations, 25 November 2002.
- Gresh, Alain. "The unsolved mystery of a Saudi bomb attack." *Le Monde diplomatique*. September 1997, 2. Available from <http://mondediplo.com/1997/09/saudi>; Internet; Accessed 19 February 2004.
- Grigg, William Norman. "'Respectable' Terrorists." *The New American*, 19 November 2001. Available from http://www.the-newamerican.com/tna/2001/11-19-2001/vol17no24_terrorists.htm; Internet; Accessed 12 February 2004.
- Gunaratna, Rohan. "Suicide Terrorism: A Global Threat." *Jane's Intelligence Review* (20 October 2000): 1-7. Available from http://www.janes.com/security/international_security/news/usscole/jir001020_1_n.shtml; Internet; Accessed 7 September 2002.
- _____. "Suicide Terrorism in Sri Lanka and India." In *Countering Suicide Terrorism*. Herzilya, Israel: The International Policy Institute for Counter Terrorism, The Interdisciplinary Center, 2002.

- Harmon, Christopher C. *Terrorism Today*. London: Frank Cass Publishers, 2000; Reprint, Portland: Frank Cass Publishers, 2001.
- Hellman, Christopher, and Reyko Huang. *List of Known Terrorist Organizations*. Washington: Center for Defense Information Terrorism Project, 2001. Available from <http://www.cdi.org/terrorism/terrorist-groups-pr.cfm>; Internet; Accessed 24 October 2002.
- Hendershot, Harold M. "CyberCrime 2003 – Terrorists' Activity in Cyberspace." [Briefing slides from the Cyber Division] Federal Bureau of Investigation, Washington, D.C. Available from <http://www.4law.co.il/L373.pdf>; Internet; Accessed 6 April 2004.
- Henderson, Harry. *Terrorism*. New York: Facts on File, 2001.
- Hettena, Seth. "Earth Liberation Front Claims Responsibility for San Diego Arson." *The Mercury News*, 18 August 2003. Available from <http://www.mercurynews.com/mld/mercurynews/news/local/6562462.htm>; Internet; Accessed 17 March 2004.
- "History of Radiological Terrorism." *Introduction to Radiological Terrorism, 1 to 3*. Available from http://www.nti.org/h_learnmore/radtutorial/chapter03_01.html; Internet; Accessed 19 May 2004.
- "History of the United Nations and Chernobyl." The United Nations and Chernobyl, 1. Available at <http://www.un.org/ha/Chernobyl/>; Internet; Accessed 1 July 2004
- Hoffman, Bruce. "All You Need Is Love: How the Terrorists Stopped Terrorism." *Atlantic Monthly* December 2001: 1-6. Available from <http://www.theatlantic.com/issues/2001/12/hoffman.htm>; Internet; Accessed 21 October 2002.
- _____. *Inside Terrorism*. New York: Columbia University Press, 1998.
- Homer-Dixon, Thomas. "The Rise of Complex Terrorism." *Foreign Policy Magazine* 1, 6, and 7, January-February 2002; available from http://www.foreignpolicy.com/story/cms.php?story_id=170; Internet; accessed 26 August 2004.
- Huntington, Samuel. "The Clash of Civilizations." *Foreign Affairs* (Summer 1993): 1-29. Available from http://www.lander.edu/atannenbaum/Tannenbaum%20courses%20folder/POLS%20103%20World%20Politics/103_huntington_clash_of_civilizations_full_text.htm#L%20THE%20NEXT%20PATTERN%20OF%20CONFLICT; Internet; Accessed 6 December 2002.
- IAEA *Safeguards Glossary*, 2001 Edition, International Nuclear Verification Series No. 3, 23. Available from <http://www-pub.iaea.org>; Internet; Accessed 22 July 2005.
- Illegal Incidents Report*. Washington: Foundation for Biomedical Research, 2002. Available from <http://www.fbresearch.org/animal-activism/eventsummary.xls>; Internet; Accessed 4 December 2002.
- Improvised Explosives*, vol. I, version 2.0. N.p., 15 May 1990. Available from <http://www.logicsouth.com/~lcoble/password/firearms.html>; Internet; Accessed 11 December 2002.
- Improvised Explosives*. N.p., n.d. Available from http://members.odinsrage.com/_white88/18_ImprovisedExplosives.htm; Internet; Accessed 11 December 2002.
- Improvised Explosive Devices*. Salem: Oregon State Police Website, 2002. Available from http://www.osp.state.or.us/html/improvised_explosives.html; Internet; Accessed 11 December 2002.
- International Encyclopedia of Terrorism*, 1997 ed., s.v. "The Media and International Terrorism."
- International Herald Tribune*, 25 March 2004. Available from <http://iht.com/articles/511745.html>; Internet; Accessed 26 March 2004.

- Italiansrus.com*. Di Meglio, Francesco. "Italian Terrorists Generate Fear in Europe." Available from <http://www.italiansrus.com/articles/ourpaesani/redbrigade.htm>; Internet; Accessed 25 February 2004.
- Jarboe, James. *See* U.S. Congress.
- Jenkins, Brian. *See* National Commission on Terrorist Attacks Upon the United States.
- Joint Chiefs of Staff, *National Military Strategy of the United States of America*, 1, May 2004.
- Joint Pub 1-02. *Department of Defense Dictionary of Military and Associated Terms*. 12 April 2001, as amended through 9 June 2004.
- Joint Pub 3-07.2. *Joint Tactics, Techniques, and Procedures for Antiterrorism*. 17 March 1998.
- Joint Task Force – Civil Support (JTF-CS)[U.S. Northern Command] website. Available at <http://www.jtfc.northcom.mil>; Internet; Accessed 14 April 2004.
- "Joint Task Force-Computer Network Operations." Offutt Air Force Base: U.S. Strategic Command Fact Sheet, 2003. Available from <http://www.stratcomaf.mil/factsheetshtml/jtf-cno.htm>; Internet; Accessed 25 June 2004.
- "Jordan 'was chemical bomb target'." BBC News UK Edition, 17 April 2004. Available at http://news.bbc.co.uk/1/hi/world/middle_east/3635381.stm; Internet; Accessed 28 April 2004.
- Juergensmeyer, Mark. *Terror in the Mind of God*. Berkeley and Los Angeles: University of California Press, 2000.
- Kaihla, Paul. "Forging Terror." *Business 2.0* December 2002: 1-3. Available from <http://www.business2.com/articles/mag/0.1640.45486%7C5.00.html>; Internet; Accessed 22 November 2002.
- Kaplan, Robert. *The Coming Anarchy: Shattering the Dreams of the Post Cold War*. New York: Random House, 2000.
- Kelley, Jack. "Terror Groups Hide Behind Web Encryption." *USA Today*, 5 February 2001. Available from <http://www.usatoday.com/tech/news/2001-02-05-binladen.htm>; Internet; Accessed 6 April 2004.
- Kurz, Anat. "War Against Terror: United We Stand?" *Jaffee Center for Strategic Studies – Strategic Assessment* 4, no. 4 (February 2002): 1-6. Available from <http://www.tau.ac.il/jcss/sa/v4n4p3Kur.html>; Internet; Accessed 11 September 2002.
- Kushner, Harvey W. *Terrorism in America: A Structured Approach to Understanding the Terrorist Threat*. Springfield, IL.: Charles C. Thomas, Publisher, Ltd., 1998.
- Laqueur, Walter. *The New Terrorism: Fanaticism and the Arms of Mass Destruction*. Oxford: Oxford University Press, 1999.
- Lasseter, Tom. "Suicide Attackers Strike Karbala," *Knight Ridder*, 27 December 2003. Available from http://www.realcities.com/mld/kwashington/news/special_packages/iraq/7581568.htm; Internet; Accessed 20 January 2004.
- Lemos, Robert. "What are the Real Risks of Cyberterrorism?" *ZDNet*, 26 August 2002. Available from http://zdnet.com.com/2102-1105_2-955293.html; Internet; Accessed 6 April 2004.
- Liang, Qiao and Wang Xiangsui. *Unrestricted Warfare*. Translated by Department of State, American Embassy Beijing Staff Translators. Washington, D.C., 1999.
- Long, David E. *The Anatomy of Terrorism*. New York: THE FREE PRESS, A Division of Macmillan, Inc., 1990.

- Lowe, Alan C. "Todo o Nada: Montoneros Versus the Army: Urban Terrorism in Argentina." In *Block by Block: The Challenges of Urban Operations*, ed. William G. Robertson and Lawrence A. Yates. Fort Leavenworth, KS: U.S. Army Command and General Staff College Press, 2003.
- "Man Portable Air Defense System (MANPADS)." *Global Security.org* (n.d.): 1. Available from <http://www.globalsecurity.org/military/intro/manpads.htm>; Internet; Accessed 19 March 2004.
- Manchester, William. *The Arms of Krupp*. Boston: Little, Brown, 1968.
- McGuire, Frank G., ed. *Security Intelligence Sourcebook, Including Who's Who in Terrorism*. Silver Spring, MD.: Interests, Ltd., 1990.
- MCIA-1100-001-93. *Infantry Weapons Identification Guide*. N.d.
- "Medical Uses." *Introduction to Radiological Terrorism*, 3. Available from http://www.nti.org/h_learnmore/radtutorial/chapter01_05.html; Internet; Accessed 19 May 2004.
- Michel, Lou and Dan Herbeck. *American Terrorist: Timothy McVeigh and the Oklahoma City Bombing*. New York: Harper Collins Publishers Inc., 2001.
- Moilanen, Jon H. "Engagement and Disarmament: A U.S. National Security Strategy for Biological Weapons of Mass Destruction." *Essays on Strategy XIII*. Washington, D.C.; National Defense University, 1996, 141-182.
- Molnar, Andrew R. See DA Pamphlet 550-104.
- Murphy, Shelley. "White Supremacist Accused of Targeting D.C. Museum." *Globe*, 20 September 2001. Available from <http://www.rickross.com/reference/supremacists/supremacists57.html>; Internet; Accessed 16 February 2004.
- Myre, Greg. "Palestinian Bomber, 14, Thwarted before Attack." *International Herald Tribune* March 2004: 1. Available from <http://www.ihf.com/articles/511745.html>; Internet; Accessed 26 March 2004.
- National Commission on Terrorist Attacks Upon the United States. Statement of Brian Jenkins to the Commission, March 31, 2003. Available from http://www.9-11commission.gov/hearings/hearing1/witness_jenkins.htm; Internet; Accessed 23 September 2004.
- National Response Plan [DHS], Final Draft, 30 June 2004. Available at <https://www.niscc.org/download/NRP%20Final%20Draft%2030%20JUN%202004.pdf>; Internet; Accessed 4 October 2004.
- National Security Institute. *Homeland Security Warns about Vehicle Bombs*. (Medway, MA, n.d.), 1-4. Available from http://nsi.org/Library/Terrorism/Vehicle_Bombs.doc; Internet; Accessed 14 January 2004.
- "NE-NE Remote Login Initial Solution Evaluation Criteria." *SONET Interoperability Forum* Document Number SIF-RL-9605-043-R4, (12 June 1996): 4. Available from <http://www.atis.org/pub/sif/approved/sif96008.pdf>; Internet; Accessed 9 April 2004.
- Newman, Bob. "Terrorists Feared to Be Planning Sub-Surface Naval Attacks." *CNS News.com*, 3 December 2002. Available from <http://www.cnsnews.com/ForeignBureaus/archive/200212/FOR20021203a.html>; Internet; Accessed 19 March 2004.
- Newman, David, ed. *Boundaries, Territory and Postmodernity*. Portland: Frank Cass Books, 1999.
- Newsday.com*, 23 July 1996. Available from <http://www.newsday.com/news/nytwa96-jet3bomb,0,2501618.story>; Internet; Accessed 12 December 2002.
- New York Times*, 18 December 1981. "Red Brigades Kidnap an American General in Verona."

- New York Times*, 13 January 2003. Available from <http://www.nytimes.com/2003/01/13/politics/13INTE.html>; Internet; Accessed 13 January 2003.
- “Oklahoma Bombing Chronology.” *Washington Post*. Available from <http://www.washingtonpost.com/wp-srv/national/longterm/oklahoma/stories/chron.htm>; Internet; Accessed 5 March 2004.
- Oman, Paul, and Edmund Schweitzer, and Jeff Roberts, “Protecting the Grid from Cyber Attack Part I: Recognizing Our Vulnerabilities.” *Utility Automation and Engineering T&D*, November 2001. Available from <http://uaelp.pennnet.com>; Internet; Accessed 24 June 2004.
- Ong, Graham Gerard. “Next Stop, Maritime Terrorism.” *Viewpoints* (12 September 2003): 1-2. Available from <http://www.iseas.edu.sg/viewpoint/ggosep03.pdf>; Internet; Accessed 2 April 2004.
- “Operation Winter Harvest: The Rescue of Brigadier James Dozier.” *Special Operations. Com*. Available from <http://www.specialoperations.com/Counterterrorism/Dozier.html>; Internet; Accessed 26 February 2004.
- Pawle, Gerald. *Secret Weapons of World War II*. New York: Ballantine Books, 1967.
- Paz, Reuven. *Hamas Publishes Annual Report on Terrorist Activity for 1998*. Herzliya, Israel: International Policy Institute for Counterterrorism, May 3, 1999. Available from <http://www.ict.org.il/spotlight/det.cfm?id=259>; Internet; Accessed 6 December 2002.
- Perl, Raphael and Ronald O’Rourke. “*Terrorist Attack on USS Cole: Background and Issues for Congress*.” Congressional Research Service, The Library of Congress. Order Code RS20721, 1. 30 January 2001. Available from <http://news.findlaw.com/cnn/docs/crs/coleterrattck13001.pdf>; Internet; Accessed 5 April 2004.
- Phillips, Thomas D. “The Dozier Kidnapping: Confronting the Red Brigades.” *Air & Space Power Chronicles* (February 2002): 1. Available from <http://www.airpower.maxwell.af.mil/airchronicles/cc/phillips.html>; Internet; Accessed 31 March 2004.
- Popenker, Max R. *Modern Firearms and Ammunition*. [Encyclopedia online]. N.p., n.d. Available from <http://world.guns.ru/main-e.htm#md>; Internet; Accessed 31 October 2002.
- Poulsen, Kevin. “Rumsfeld Orders .mil Web Lockdown.” *The Register*, 17 January 2003. Available from http://www.theregister.co.uk/2003/01/17/rumsfeld_orders_mil_web_lockdown; Internet; Accessed 8 April 2004.
- Powell, William. *The Anarchist Cookbook*. Secaucus, NJ: Lyle Stuart, Inc., 1971.
- Prados, Alfred B. Congressional Research Service (CRS) Issue Brief for Congress. *Saudi Arabia: Current Issues and U.S. Relations*, 15 September 2003. Order Code IB93113.
- Quinn, Andrew. “Teen Hackers Plead Guilty to Stunning Pentagon Attacks.” *Reuters*, 31 July 1998, 1. Available from <http://www.geocities.com/Area51/Shadowlands/6583/project395.html>; Internet; Accessed 14 April 2004.
- Ra’anan, Uri, ed., et al. *Hydra of Carnage: International Linkages of Terrorism*. Lexington: Lexington Books, 1986.
- Rapoport, David C., ed. *Inside Terrorist Organizations*. New York: Columbia University Press, 1988.
- Raufur, Xavier. “New World Disorder, New Terrorisms: New Threats for the Western World.” In *The Future of Terrorism*, edited by Max. Taylor and John Horgan. Portland: Frank Cass Publishers, 2000.
- Reich, Walter, ed. *Origins of Terrorism: Psychologies, Ideologies, Theologies, States of Mind*. Rev. ed. Washington: Woodrow Wilson Center Press, 1998.
- “Revolutionary Organization 17 November (17N).” CDI Terrorism Project, 5 August 2002. Available from <http://www.cdi.org/terrorism/17N-pr.cfm>; Internet; Accessed 24 September 2004.

- Rhodes, Richard. "Living With The Bomb." *National Geographic*, 208, No. 2 (August 2005): 104.
- Richardson, Michael. "A Time Bomb for Global Trade: Maritime-related Terrorism in an Age of Weapons of Mass Destruction." *Viewpoints* (25 February 2004): 8. Available from <http://www.iseas.edu.sg/viewpoint/mricsumfeb04.pdf>; Internet; Accessed 5 April 2004.
- Robinson, Colin. *Military and Cyber-Defense: Reactions to the Threat* Washington: Center for Defense Information Terrorism Project, 2002. Available from <http://www.cdi.org/terrorism/cyberdefense-pr.cfm>; Internet; Accessed 24 June 2004.
- Rosenbraugh, Craig. "Craig Rosenbraugh on the Anti-War Struggle." *Houston Independent Media Center*, 17 March 2003. Available from <http://houston.indymedia.org/news/2003/03/9125.php> ; Internet; Accessed 16 February 2004.
- "Ruby Ridge Federal Siege, Bibliography." [Bibliography on-line]. Available from http://users.skynet.be/terroism/html/usa_ruby_ridge.htm; Internet; Accessed 16 March 2004.
- Rumsfeld, Donald H. See U.S. Department of Defense.
- St. Petersburg Times*, 9 December 1999. Dougherty, Larry. "Indictment details plot to blow up power lines." Available from http://www.sptimes.com/News/120999/TampaBay/Indictment_details_pl.shtml; Internet; Accessed 16 February 2004.
- "SAMs and the Targeting of Israeli Airliners." *Jane's Terrorism Intelligence Center* (28 November 2002): 1. Available from http://www.janes.com/security/international_security/news/jtic/jtic021128_1_n.shtml; Internet; Accessed 30 December 2002.
- Schama, Simon. *Citizens: A Chronicle of The French Revolution*. New York: Alfred A. Knopf, Inc., 1989.
- Schoomaker, Peter. Army Chief of Staff, "CSA Interview: Joint and Expeditionary Capabilities." (Washington, D.C.: Pentagon, 4 October, 2004). Available from <http://www.army.mil/leaders/leaders/csa/interviews/04Oct04.html>; Internet; Accessed 11 January 2005.
- _____. U.S. Army Chief of Staff, "Media Roundtable at the Association of the United States Army Annual Convention." Washington, D.C., 4 October 2004. Available from: <http://www.army.mil/leaders/leaders/csa/interviews/04Oct04Roundtable.html>; Internet; Accessed 11 January 2005.
- Schuurman, Jan. *Tourists or Terrorists?* Press review on-line. Radio Netherlands, 25 April 2002. Available from <http://www.rnw.nl/hotspots/html/irel020425.html>; Internet; Accessed 13 February 2004.
- Schweitzer, Glenn E., and Carole C. Dorsch. *Superterrorism; Assassins, Mobsters, & Weapons of Mass Destruction*. New York: Plenum Trade Press, 1998.
- Schweitzer, Yoram. "Suicide Terrorism: Development and Main Characteristics." In *Countering Suicide Terrorism*. Herzilya, Israel: The International Policy Institute for Counter Terrorism, The Interdisciplinary Center, 2002.
- Serrano, Richard A. "Terry Nichols Sentenced to Life With No Hope of Parole." *Los Angeles Times*, 5 June 1998. Available from <http://www.-tech.mit.edu/V118/N27/nichols.27w.htm>; Internet; Accessed 16 February 2004.
- Silverstein, Ken. "David Hahn, Boy Atomic Scientist." *ASEPCO*, [Originally printed in *Harpers's Magazine*, November 1998]. Available at http://www.asepco.com/David_Hahn_Boy_Scientist.htm; Internet; Accessed 31 August 2004.
- Simons, Lewis M. "Weapons of Mass Destruction: An Ominous New Chapter Opens on the Twentieth Century's Ugliest Legacy." *National Geographic* 202, no. 5 (November 2002): 2-35.

- Smith, Brent L. *Terrorism in America: Pipe Bombs and Pipe Dreams*. Albany: State University of New York Press, 1994.
- “Software - Programming Jobs are Heading Overseas by the Thousands. Is there a Way for the U.S. to Stay on Top?” *Business Week online*, 1 March 2004. Available from http://businessweek.com/magazine/content/04_09/b3872001_mz001.htm; Internet; Accessed 9 April 2004.
- “Sprint Inks Outsourcing Pacts with EDS, IBM.” *Dallas Business Journal*, (16 September 2003). Available from <http://www.bizjournals.com/dallas/stories/2003/09/15/daily21.html>; Internet; Accessed 9 April 2004.
- Sprinzak, Ehud. “Rational Fanatics.” *Foreign Policy*, no. 120 (September/October 2000): 66-73.
- Straits Times Interactive*, 16 October 2003. Rekhi, Shefali. “Next terror target.” Available from <http://www.google.com/search?hl=en&lr=&ie=UTF-8&q=terro+AND+attack+AND=underwater&btnG=Google+Search>; Internet; Accessed 21 January 2004.
- Suicide Terror: It's Use and Rationalization*. Jerusalem: Israeli Ministry of Foreign Affairs Website, 23 July 2002. Available from <http://www.mfa.gov.il/mfa/go.asp?MFAH0m6k0>; Internet; Accessed 11 November 2002.
- “Suicide Terrorism.” *The Economist* (January 2004): 3. Available from <http://quicksitebuilder.cnet.com/supfacts/id396.html>; Internet; Accessed 17 March 2004.
- “Suicide Terrorism in Comparative Perspective.” In *Countering Suicide Terrorism*. Herzilya, Israel: The International Policy Institute for Counter Terrorism, The Interdisciplinary Center, 2002.
- “Suicide Terrorism: a Global Threat.” *Jane's Intelligence Review* (October 2000): 1, 4-5. Available from http://www.janes.com/security/international_security/news/usscole/jir001020_1_n.shtml; Internet; Accessed 20 January 2004.
- Sullivan, John P., et al. *Jane's Unconventional Weapons Response Handbook*. Alexandria, VA: Jane's Information Group, 2002.
- Sunzi. *The Art of War/Sun Tzu*. Translated by Samuel B. Griffith. New York: Oxford University Press, 1971.
- Tal, Nachman. “Suicide Attacks: Israel and Islamic Terrorism.” *Jaffee Center for Strategic Studies – Strategic Assessment* 5, no. 1 (June 2002): 1-9.
- Taylor, Max, and John Horgan, ed. *The Future of Terrorism*. Portland: Frank Cass Publishers, 2000.
- Teitelbaum, Joshua and David Long. “Islamic Politics in Saudi Arabia.” *The Washington Institute for Near East Policy, Policywatch: Special Policy Forum Report Number 259*, 9 July 1997, 1 to 3. Available at <http://www.washingtoninstitute.org/watch/Policywatch/policywatch1997/259.htm>; Internet; Accessed 19 February 2004.
- “Terrorist Attacks on Americans 1979-1988.” 2. Available from <http://www.pbs.org/wgbh/pages/frontline/shows/target/etc/cron.html>; Internet; Accessed 1 July 2004
- “Terrorists Demand Extortion Cash in Euros.” *TCM Breaking News* (September 2001): 1. Available from <http://archives.tcm.ie/breakingnews/2001/09/04/story22584.asp>; Internet; Accessed 31 March 2004.
- “Terrorists and Radiological Terrorism.” *Introduction to Radiological Terrorism*, 2 and 3. Available from http://www.nti.org/h_learnmore/radtutorial/chapter04_02.html; Internet; Accessed 19 May 2004.
- Thachuck, Kimberly L. “Terrorism's Financial Lifeline: Can it Be Severed.” *Strategic Forum* no. 191 (May 2002): 1-15. Available from <http://www.ndu.edu/inss/strforum/sf191.htm>; Internet; Accessed 29 August 2002.

- “The Asymmetric Threat From Maritime Terrorism.” Available from http://jfs.janes.com/public/jfs/additional_info.shtml; Internet; Accessed 2 February 2004.
- The Madrid Agenda*, Club de Madrid, available from <http://www.clubmadrid.org/cmadrid>; Internet; accessed 26 April 2005.
- “The New Threat of Organized Crime and Terrorism.” *Jane’s Terrorism & Security Monitor* (6 June 2000): 1-5. Available from http://www.janes.com/security/international_security/news/jtms/jtms000619_1_n.shtml; Internet; Accessed 27 June 2000.
- The *Posse Comitatus Act*, 18 U.S.C. 1385
- The *Robert. T. Stafford Disaster Relief and Emergency Assistance Act*, 42 U.S.C. 5121-5206
- The White House. National Security Presidential Directive 17 (NSPD-17), *National Strategy to Combat Weapons of Mass Destruction*, 2, December 2002. Available at <http://www.fas.org/irp/offdocs/nspd/nspd-17.html>; Internet; Accessed 8 December 2003.
- The White House, *The National Strategy for the Physical Protection of Critical Infrastructure and Key Assets*. Washington, D.C., February 2003. Preface by The President of the United States of America. Available from http://www.whitehouse.gov/pcipb/physical_strategy.pdf; Internet; Accessed 8 December 2003.
- The White House. *The National Security Strategy of the United States of America*, 1, 17 September 2002. Available at <http://www.whitehouse.gov/nsc/nss.html>; Internet; Accessed 30 April 2004.
- The White House. *The National Strategy to Secure Cyberspace*. Washington, D.C., February 2003. Preface by The President of the United States of America. Available from http://www.whitehouse.gov/pcipb/cyberspace_strategy.pdf; Internet; Accessed 8 December 2003.
- TM 31-201-1. *Unconventional Warfare Devices and Techniques: Incendiaries*. May 1966.
- TM 31-210. *Improvised Munitions Handbook*. 1969.
- “Too Painful.” *ABC News*. News on-line, 11 November 2004. Available from http://abcnews.go.com/sections/Primetime/US/Jessica_Lynch_031106-1.html; Internet; Accessed 12 February 2004.
- “Transcript of President George Bush’s Address 10/07/01. ‘Attack on America’.” Available <http://multimedia.belointeractive.com/attack/bush/1007bushtranscript.html>; Internet; Accessed 13 July 2004.
- Truby, J. David. *How Terrorists Kill: The Complete Terrorist Arsenal*. Boulder: Paladin Press, 1978.
- USAEUR Pamphlet 30-60-1. *Identification Guide: Part One, Weapons and Equipment East European Communist Armies; Volume I: General, Ammunition and Infantry Weapons*. 30 September 1972.
- U.S. Air Force. *Independent Review of the Khobar Towers Bombing, Part A* (31 October 1996) by Lieutenant General James F. Record. Available from http://www.fas.org/irp/threat/khobar_af/recordf.htm; Internet; Accessed 9 February 2004.
- U.S. Air Force. *Independent Review of the Khobar Towers Bombing, Part A; Appendix 1, Comments Regarding the Downing Report* (31 October 1996) by Lieutenant General James F. Record. Available from http://www.fas.org/irp/threat/khobar_af/recordap.htm; Internet; Accessed 9 February 2004.
- U.S. Army Field Manual FM 7-100, *Opposing Force Doctrinal Framework and Strategy*, May 2003, iv to xvi.
- U.S. Congress. House. Armed Services Special Oversight Panel on Terrorism, *Cyberterrorism*, Testimony by Dorothy E. Denning, Georgetown University. Washington, D.C., 23 May 2000. Available from <http://www.cs.georgetown.edu/~denning/infosec/cyberterror.html>; Internet; Accessed 9 April 2004.

- U.S. Congress. House. Armed Services Subcommittee on Terrorism, Unconventional Threats and Capabilities. *Cyber-Terrorism*. Statement by Major General James D. Bryan, U.S. Army Commander, Joint task Force-Computer Network Operations, U.S. Strategic Command and Vice Director, Defense Information Systems Agency. Washington, D.C., 24 July 2003. Available from <http://www.defenselink.mil/search97/s97is.vts?Action=FilterSearch&Filter=dl.hts&query=cyber-terrorism>; Internet; Accessed 6 April 2004.
- U.S. Congress. House. Resources Subcommittee on Forests and Forest Health. *The Threat of Eco-Terrorism*. Statement by the FBI's Domestic Terrorism Section Chief, James Jarboe. Washington, D.C., 12 February 2002. Available from <http://www.fbi.gov/congress/congress02/jarboe021202.htm>; Internet; Accessed 17 January 2003.
- U.S. Congress. Senate. Armed Services Committee. *SASC Cole Commission Testimony: Hearing before the Armed Services Committee*. 107th Cong. 3 May 2001. Comments by Chairman of the Joint Chiefs of Staff.
- U.S. Congress. Senate. Judiciary Subcommittee on Terrorism, Technology, and Homeland Security, *Cyber Terrorism*. Testimony of Keith Lourdeau, Deputy Assistant Director, Cyber Division, FBI, Washington, D.C., 24 February 2004, 3. Available from <http://www.fbi.gov/congress/congress04/lourdeau022404.htm>; Internet; Accessed 15 April 2004.
- U.S. Department of Agriculture. "Final BSE Update – Monday, February 9, 2004." Newsroom Release Statement No. 0074.04. Available from <http://www.usda.gov/Newsroom/0074.04.html>; Internet; Accessed 12 July 2004.
- U.S. Department of Commerce. National Institute of Standards and Technology, *Risk Management Guide for Information Technology Systems*, NIST Special Publication 800-30, by Gary Stoneburner, Alice Goguen, and Alexis Feringa. Washington, D.C., 2001: 22. Available from <http://csrc.nist.gov/publications/nistpubs/800-30/sp800-30.pdf>; Internet; Accessed 12 April 2004.
- U.S. Department of Defense. *11th Psychological Operations Task Force After Action Report for SFOR X*, by Clint A. Venekamp. Upper Marboro, MD, July 2002.
- U.S. Department of Defense. "A Global Terror Group Primer," by Jim Garamone. *Defense Link* (14 February 2002): 1-7. Available from http://www.defenselink.mil/news/Feb2002/n02142002_200202141.html; Internet; Accessed 29 August 2002.
- U.S. Department of Defense, Defense Science Board, *Defense Science Board Task Force on The Role and Status of DoD Red Teaming Activities*, (Washington, D.C.: Office of the Under Secretary of Defense for Acquisition, Technology, and Logistics, September 2003).
- U.S. Department of Defense. Defense Security Service, *Technology Collection Trends in the U.S. Defense Industry 2002*. Alexandria, VA, n.d. Available from <http://www.wright.edu/rsp/Security/TechTrends.pdf>; Internet; Accessed 19 April 2004.
- U.S. Department of Defense. *DoD USS Cole Commission Report* (9 January 2001) by U.S. Army Gen. (Ret) William Crouch and U.S. Navy Adm. (Ret) Harold Gehman. Open-File Report, U.S. Department of Defense. 1 (Washington, D.C., 9 January 2001). Available at <http://www.fas.org/irp/threat/cole.html>; Internet; Accessed 16 February 2004.
- U.S. Department of Defense. Naval Explosive Ordnance Disposal Technology Division. *ORDATA II - Enhanced Deminers' Guide to UXO Identification, Recovery, and Disposal*, Version 1.0, [CD-ROM]. Indian Head, MD: Naval Explosive Ordnance Disposal Technology Division, 1999.
- U.S. Department of Defense. News Release Archive. "DoD News: Navy Announces Results of Its Investigation on USS Cole." Available from http://www.defenselink.mil/releases/2001/b011192001_bt031-01.html; Internet; Accessed 11 February 2004.

- U.S. Department of Defense. *Report of the Assessment of the Khobar Towers Bombing* (30 August 1996) Letter by General (USA Retired) Wayne A. Downing. Available from <http://www.fas.org/irp/threat/downing/downltr.html>; Internet; Accessed 10 February 2004.
- U.S. Department of Defense. *Report of the Assessment of the Khobar Towers Bombing* (30 August 1996) by General (USA Retired) Pre by Wayne A. Downing. Available from <http://www.fas.org/irp/threat/downing/prefuncl.html>; Internet; Accessed 10 February 2004.
- U.S. Department of Defense. *Report of the Assessment of the Khobar Towers Bombing* (30 August 1996) by General (USA Retired) Rpt by Wayne A. Downing. Available from <http://www.fas.org/irp/threat/downing/unclf913.html>; Internet; Accessed 9 February 2004.
- U.S. Department of Defense. *Report to Congress on The Role of the Department of Defense in Supporting Homeland Security*. Washington, D.C., September 2003.
- U.S. Department of Defense. *Report on Personal Accountability for Force Protection at Khobar Towers*, by William S. Cohen. Washington, D.C., July 31, 1997.
- U.S. Department of Defense. Report to the President. *The Protection of U.S. Forces Deployed Abroad* (15 September 1996) by Secretary of Defense William J. Perry. Available from http://www.fas.org/irp/threat/downing/report_f.html; Internet; Accessed 18 February 2004.
- U.S. Department of Defense. *Special Briefing on the Unified Command Plan*, by Donald H. Rumsfeld. Department of Defense News Briefing Transcript presented at the Pentagon, Wednesday, 17 April 2002 – 11:30a.m. Available from http://www.defenselink.mil/news/Apr2002/t04172002_t0417sd.html; Internet; Accessed 18 November 2002.
- U.S. Department of Defense. *The National Defense Strategy of the United States of America*. (Washington, D.C.: GPO, 1 March 2005), iv.
- U.S. Department of Defense. Threat Support Directorate TRADOC DCSINT. *Homeland Defense Handbook*. Fort Leavenworth, KS, 31 October 2001.
- U.S. Department of Defense. Threat Support Directorate TRADOC DCSINT. *OPFOR Worldwide Equipment Guide*. Fort Leavenworth, KS, 24 September 2001.
- U.S. Department of Defense. U.S. Army John F. Kennedy Center for Special Warfare. *U.S. Army Special Forces Foreign Weapons Handbook*. Fort Bragg, N.C., 1 January 1967.
- U.S. Department of Defense. U.S. Army Intelligence Agency. Foreign Science and Technology Center. (S/NF/WN/NC) *Terrorist Weapons Handbook – Worldwide* (U), by Steven A. Chester. Washington, D.C., 15 December 1989. [Unclassified extract].
- U.S. Department of Defense. U.S. Marine Corps. Marine Corps University. Corporals Noncommissioned Officers Program. *Force Protection*. Quantico, VA, January 1999.
- U.S. Department of Defense. Washington Headquarters Services. Directorate for Information Operations and Reports. *Global War on Terrorism – Casualty Summary Operation Enduring Freedom*. Washington, D.C., As of 4 March 2004. Available from <http://web1.whs.osd.mil/mmids/casualty/WOTSUM.pdf>; Internet; Accessed 15 March 2004.
- U.S. Department of Defense. Washington Headquarters Services. Directorate for Information Operations and Reports. *Table 13, Worldwide U.S. Active Duty Military Deaths, Selected Military Operations*. Washington, D.C., n.d. Available from <http://web1.whs.osd.mil/mmids/casualty/table13.htm>; Internet; Accessed 15 March 2004.

- U.S. Department of Defense. Washington Headquarters Services. Directorate for Information Operations and Reports. *U.S. Active Duty Military Deaths – 1980 through 2002*. Washington, D.C., As of 10 April 2003. Available from http://web1.whs.osd.mil/mmids/casualty/Death_Rates.pdf; Internet; Accessed 16 January 2004.
- U.S. Department of Defense. Washington Headquarters Services. Directorate for Information Operations and Reports. *War on Terrorism – Operation Iraqi Freedom, By Casualty Category within Type*. Washington, D.C., As of 26 February 2004. Available from <http://web1.whs.osd.mil/mmids/casualty/OIF-Total.pdf>; Internet; Accessed 15 March 2004.
- U.S. Department of Justice. “Al Qaeda Associates Charged in Attack on USS Cole, Attempted Attack on Another U.S. Naval Vessel.” Public Relations Release #298: 05-15-03, 3. 15 May 2003. Available on http://www.usdoj.gov/opa/pr/2003/May/03_298.htm; Internet; Accessed 16 February 2004.
- U.S. Department of Justice. Federal Bureau of Investigation. Counterterrorism Threat Assessment and Warning Unit. Counterterrorism Division. *Terrorism in the United States 1999*. Report 0308. Washington, D.C., n.d.
- U.S. Department of Justice. Office of Justice Programs. Office for Victims of Crime. *Responding to Terrorism Victims* (October 2000), by Kathryn M. Turman, Director. Available at <http://www.ojp.usdoj.gov/ovc/publications/infores/respterrorism/welcome.html>; Internet; Accessed 11 March 2004.
- U.S. Department of Justice. U.S. Attorney, Northern District of California. Press Release, *Louisiana Man Arrested for Releasing 911 Worm to WebTV Users*, (San Francisco, CA, 19 February 2004), 1. Available from <http://www.usdoj.gov/criminal/cybercrime/jeansonneArrest.htm>; Internet; Accessed 12 April 2004.
- U.S. Department of Justice. U.S. Attorney, Southern District of California. Press Release, *President of San Diego Computer Security Company Indicted in Conspiracy to Gain Unauthorized Access into Government Computer*. San Diego, CA, 29 September 2003. Available from <http://www.usdoj.gov/criminal/cybercrime/okeefeArrest.htm>; Internet; Accessed 12 April 2004.
- U.S. Department of Justice. U.S. District Court for the Eastern District of Virginia. Alexandria Division, Indictment, *United States of America v. Gary McKinnon*. Alexandria, VA, November 2002. Available from <http://news.findlaw.com/hdocs/docs/cyberlaw/usmck1102vaind.pdf>; Internet; Accessed 16 April 2004.
- U.S. Department of State. Bureau of Diplomatic Security. *State Department Diplomatic Security Surveillance Detection Program Course of Instruction* [CD-ROM]. Washington, D.C., October 1999.
- U.S. Department of State. “Clinton Letter to Congress on U.S.S. Cole Attack.” *International Information Programs, Washington File*. Available from <http://usinfo.state.gov/topical/pol/terro/00101603.htm>; Internet; Accessed 1 April 2004.
- U.S. Department of State. International Information Programs Bulletin. *Justice Department on Khobar Towers Explosion Indictments*, 21 June 2001. Available from <http://usinfo.state.gov/topical/pol/terror/01062102.htm>; Internet; Accessed 10 February 2004.
- U.S. Department of State. Office of the Coordinator for Counterterrorism. *Patterns of Global Terrorism 2001*. Washington, D.C., May 2002.
- U.S. Department of State. Office of the Coordinator for Counterterrorism. *Patterns of Global Terrorism 2002*. Washington, D.C., 2003.
- U.S. Department of State. Office of the Coordinator for Counterterrorism. *Patterns of Global Terrorism 2004*. Washington, D.C., 2004, revised 22 June 2004.
- U.S. Department of State. Office of Counterterrorism. *Foreign Terrorist Organizations*. Washington, D.C., 9 August 2002. Available from <http://www.state.gov/s/ct/rls/fs/2002/12389.htm>; Internet; Accessed 29 August 2002.

- U.S. Department of State. Office of the Historian. Bureau of Public Affairs. *Significant Terrorist Incidents, 1961-2001: A Chronology*. Washington, D.C., 31 October 2001. Available from http://www.fas.org/irp/threat/terror_chron.html; Internet; Accessed 30 January 2003.
- U.S. Department of State. U.S. Embassy, Jakarta, Indonesia. *Threats Involving Vehicle Borne Improvised Explosive Devices*. Jakarta, Indonesia, 2003, 2. Available from http://www.usembassyjakarta.org/vbied_vehicles.html; Internet; Accessed 14 January 2004.
- U.S. Department of the Treasury. Office of the Comptroller of the Currency. *Infrastructure Threats from Cyber-Terrorists*, OCC Bulletin 99-9. Washington, D.C., 5 March 1999, 2. Available from <http://www.occ.treas.gov/ftp/bulletin/99-9.txt>; Internet; Accessed 6 April 2004.
- U.S. Director of Central Intelligence. DCI Counterterrorist Center. *International Terrorism in 1997: A Statistical View*. Washington, D.C., 1998. Available from <http://www.fas.org/irp/threat/terror97cia>; Internet; Accessed 3 February 2003
- U.S. Director of Central Intelligence. DCI Weapons Intelligence, Nonproliferation, and Arms Control Center. *Unclassified Report to Congress on the Acquisition of Technology Relating to Weapons of Mass Destruction and Advanced Conventional Munitions, 1 January Through 30 June 2001*. Washington, D.C., January 2002.
- U.S. Director of Central Intelligence. Interagency Intelligence Committee on Terrorism. Chemical, Biological and Radiological (CBRN) Subcommittee. *Chemical/Biological/Radiological Incident Handbook*. Washington, D.C., October 1998. Available from <http://images.google.com/imgres?imgurl=http://www.usis.usemb.se/Environment/images/p1.gif&imgrefurl=http://www.usis.usemb.se/Environment/&h=158&w=168&prev=images%3Fq%3Dus%2Bgovernment%26svnum%3D10%26hl%3Den%26lr%3D%26ie%3DUTF-8%26oe%3DUTF-8>; Internet; Accessed 13 February 2003.
- U.S. Director of Central Intelligence. Interagency Intelligence Committee on Terrorism. Community Counterterrorism Board. (FOUO) *Improvised Explosive Devices (IEDs) and Other Criminal and Terrorist Devices: A Basic Reference Manual*. Washington, D.C., September 2000.
- U.S. District Court, District of Colorado. Criminal Action No. 95-CR-110. United States of America, Plaintiff, vs. Timothy James McVeigh and Terry Lynn Nichols, Defendants. “8/95 Grand Jury Indictment of McVeigh and Nichols.” Indictment Count One (Conspiracy to Use a Weapon of Mass Destruction), 1995, 1. Available from <http://www.lectlaw.com/files/cas44.htm>; Internet; Accessed 2 February 2004.
- U.S. District Court, District of Colorado. Criminal Action No. 96-CR-68. United States of America, Plaintiff, vs. Timothy James McVeigh, Defendant. The McVeigh Trial’s April 24, 1997 Opening Statement by the [U.S.] Government. Available from <http://www.lectlaw.com/bomb.html>; Internet; Accessed 5 March 2004.
- U.S. District Court, Eastern District of Virginia, Alexandria Division. Grand Jury *Indictment* of 46 counts against named and unspecified terrorists charged in the Khobar Towers bombing attack of 25 June 1996. Available from <http://www.fbi.gov/pressrel/pressrel01/khobar.pdf>; Internet; Accessed 10 February 2004.
- U.S. District Court, Southern District of New York. Indictment S12 98 Cr. 1023 (KTD). United States of America, Plaintiff, vs. Jamal Ahmed Mohammed Ali Al-Badawi and Fahd Al-Quso, Defendants. Available from <http://news.findlaw.com/hdocs/docs/cole/usalbadawi051503ind.pdf>; Internet; Accessed 5 April 2004.
- U.S. District Court, Western District of Oklahoma. Case No. M-95-105-H. United States of America. Plaintiff, vs. Terry Lynn Nichols, Defendant. “Terry Nichols Criminal Complaint.” Affidavit. 9 May 1995, 2. Available from <http://www.lectlaw.com/files/cur18.htm>; Internet; Accessed 16 February 2004.
- U.S. District Court, Western District of Oklahoma. Case No. M-95-105-H. United States of America. Plaintiff, vs. Michael J. Fortier, Defendant. “Michael Fortier’s Plea Agreement.” Affidavit. 10 August 1995, 2. Available from <http://www.lectlaw.com/files/cas37.htm>; Internet; Accessed 16 February 2004.

- U.S. General Accounting Office. *Information Security: Computer Attacks at Department of Defense Pose Increasing Risks*, Report AIMD-96-84. Washington, D.C., 22 May 1996. Available from <http://www.fas.org/irp/gao/aim96084.htm>; Internet; Accessed 12 April 2004.
- U.S. House National Security Committee. *Report on the Bombing of Khobar Towers* 14 August 1996. Statement of Chairman Floyd D. Spence and Staff Report. Available from <http://www.fas.org/irp/threat/saudi.pdf>; Internet; Accessed 10 February 2004.
- U.S. Joint Chiefs of Staff, J5 War on Terrorism, Strategic Planning Division. Briefing (U) *The National Military Strategic Plan for the War on Terrorism (NMSP-WOT)*. Version 18 April 2005.
- Joint Chiefs of Staff, J5 War on Terrorism, Strategic Planning Division. Briefing (U) *Countering Ideological Support for Terrorism*. Version 19 Jan 05, 5 April 2005.
- USNORTHCOM [U.S. Northern Command] website. Available at <http://www.northcom.mil>; Internet; Accessed 28 April 2004.
- “U.S. Officials Charge Briton for Hacking Pentagon.” *Asian School of Cyber Laws*, November 2002. Available from http://www.asianlaws.org/cyberlaw/archives/11_02_penta.htm; Internet; Accessed 16 April 2004.
- U.S. Title 28. Code of Federal Regulations. Section 0.85. *Judicial Administration*. Washington, D.C., July 2001.
- Van Creveld, Martin L. *The Transformation of War*. New York: The Free Press, 1991.
- Venekamp, Clint A. See U.S. Department of Defense.
- Venzke, Ben N. *Al-Qaeda Targeting Guidance – v1.0, Thursday 1 April 2004*. Alexandria: IntelCenter/Tempest Publishing, 2004.
- Venzke, Ben N., and Aimee Ibrahim. *Al-Qaeda Tactic/Target Brief*. Alexandria: Intel Center/Tempest Publishing, 2002.
- _____. *The al-Qaeda Threat: An Analytical Guide to al-Qaeda’s Tactics and Targets*. Alexandria: Tempest Publishing, LLC, 2003, 36, quoting Abu ‘Ubeid al-Qurashi, “The Nightmares of America, 13 February 2002.
- von Clausewitz, Karl. *War, Politics and Power*. Chicago: Regnery Gateway, 1962.
- Vinocur, John. “Bomb Attempt on Gen. Haig’s Life Not Tied to Major Terrorist Groups.” *New York Times*, 27 June 1979.
- _____. “U.S. General Safe in Raid in Germany.” *New York Times*. 16 September 1981.
- “Waco – Branch Davidian Files.” Available from <http://www.paperlessarchives.com/waco.html>; Internet; Accessed 16 March 2004.
- Wagamon, Ed. “Tactical Combat in Chechnya: Mines & Booby Traps: The Number One Killer” (Part 1 of 2). *How They Fight: Armies of the World*, NGIC-1122-0062-01, vol 4-01 (August 2001): 33-37.
- Walsh, Elsa. “Louis Freech’s Last Case.” *The New Yorker*, 14 May 2001. Available from http://www.newyorker.com/printable/?archive/010924fr_archive06; Internet; Accessed 12 February 2004.
- The War on Terrorism: The U.S. and the S.P.L.A.* London: The European-Sudanese Public Affairs Council Press Release, 12 October 2001. Available from <http://allafrica.com/stories/200110120528.html>; Internet; Accessed 12 November 2002.
- Washington Times.com*. 1 December 2003. Available from <http://www.washtimes.com/upi-breaking/20031201-025645-3524r.htm>; Internet; Accessed 2 April 2004.

- Weapons of Mass Destruction*. New York: United Nations Office on Drugs and Crime, December 2002. Available from http://www.undcp.org/odccp/terrorism_weapons_mass_destruction_page006.html; Internet; Accessed 19 December 2002.
- “Weapons of Terror.” *ADL* (8 April 2002): 1. Available from http://www.adl.org/israel/weapons_list.asp; Internet; Accessed 8 January 2003.
- West, Woody. “The Last Word.” *Insight: On the News*, 16 November 2001. Available from <http://www.insightmag.com/news/2001/12/10/Features/The-Last-Word-148069.shtml>; Internet; Accessed 12 February 2004.
- “What is Radiological Terrorism?” *Introduction to Radiological Terrorism*, 1 and 2. Available from http://www.nti.org/h_learnmore/radtutorial/chapter01_03.html; Internet; Accessed 19 May 2004.
- White, Jerry. “Ridding the World of Land Mines.” *Union-Tribune* (January 24, 2002): 4-5. Available from <http://www.wand.org/9-11/discuss6.html>; Internet; Accessed 13 December 2002.
- Williscroft, Robert G. “The Economics of Demining Defines Success and Failure.” *Defense Watch* February 13, 2002: 1-17. Available from <http://www.sftt.org/dw02132002.html>; Internet; Accessed 13 December 2002.
- Zakis, Jeremy. *Annual Report of International Terrorist Activity, 2001*. Chicago: The Emergency Response and Research Institute, 2002. Available from http://www.emergency.com/2002/erri_ter2001.pdf; Internet; Accessed 7 November 2002

This Page Intentionally Blank

This Page Intentionally Blank



“The battle is now joined on many fronts.
We will not waiver, we will not tire,
we will not falter, and we will not fail.
Peace and freedom will prevail...
To all the men and women in our military,
every sailor, every soldier, every airman,
every coast guardsman, every marine,
I say this: Your mission is defined.
The objectives are clear. Your goal is just.
You have my full confidence, and you will have
every tool you need to carry out your duty.”

President
United States of America

A Military Guide to Terrorism in the 21st Century
U.S. Army Training and Doctrine Command
Deputy Chief of Staff for Intelligence
Assistant Deputy Chief of Staff for Intelligence-Threats
Fort Leavenworth, Kansas

DISTRIBUTION RESTRICTION: Approved for public release; distribution unlimited.